

Installation instructions, accessories

Volvo Car Corporation Gothenburg, Sweden

| | | |
|-----------------------|----------------|------------------|
| Instruction No | Version | Part. No. |
| 31399626 | 1.0 | 31399209 |

Sun curtain

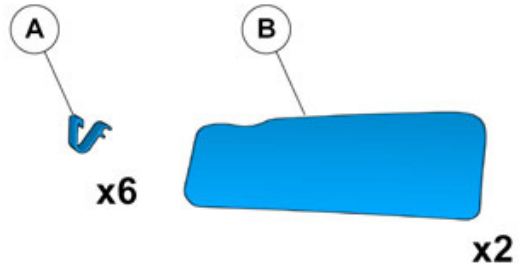

IMG-381688

Installation instructions, accessories

Volvo Car Corporation Gothenburg, Sweden

Information

1

Read through all of the instructions before starting installation.

Notifications and warning texts are for your safety and to minimise the risk of something breaking during installation.

Ensure that all tools stated in the instructions are available before starting installation.

Certain steps in the instructions are only presented in the form of images. Explanatory text is also given for more complicated steps.

In the event of any problems with the instructions or the accessory, contact your local Volvo dealer.

Color symbols

2

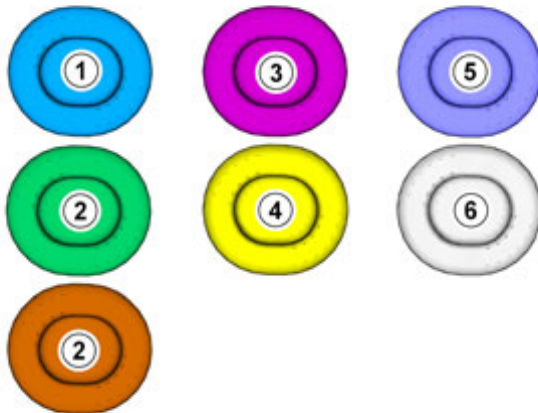

IMG-363036

Note!

This colour chart displays (in colour print and electronic version) the importance of the different colours used in the images of the method steps.

1. Used for focused component, the component with which you will do something.
 2. Used as extra colors when you need to show or differentiate additional parts.
 3. Used for attachments that are to be removed/installed. May be screws, clips, connectors, etc.
 4. Used when the component is not fully removed from the vehicle but only hung to the side.
 5. Used for standard tools and special tools.
 6. Used as background color for vehicle components.
-

Accessory installation

Installation instructions, accessories

Volvo Car Corporation Gothenburg, Sweden

3



IMG-378742

4

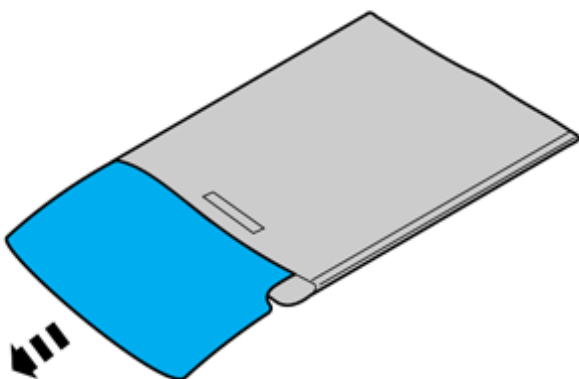

IMG-378747

Installation instructions, accessories

Volvo Car Corporation Gothenburg, Sweden

5

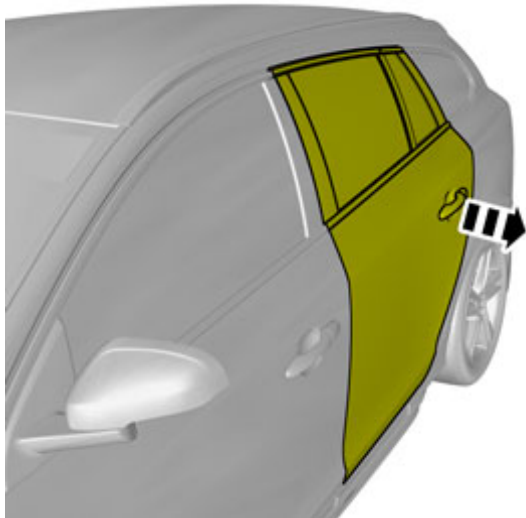

IMG-381694

Installation

6

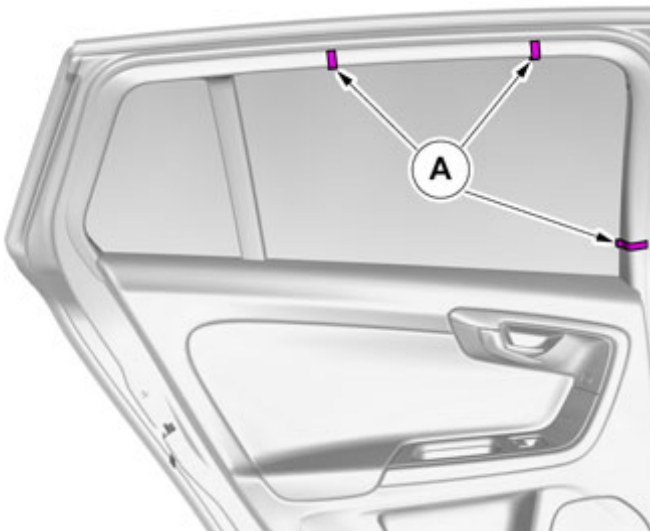

IMG-381690

Installation instructions, accessories

Volvo Car Corporation Gothenburg, Sweden

7



IMG-381691

8

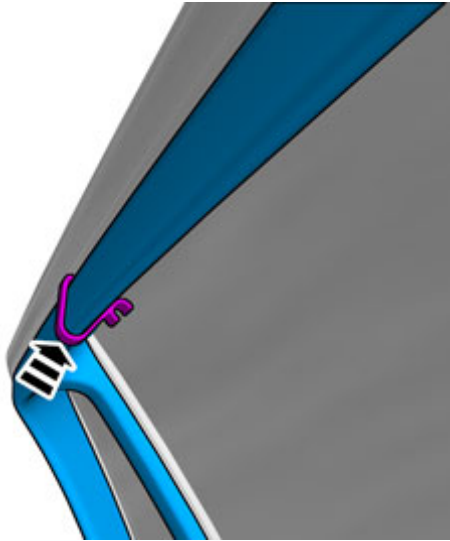

IMG-381692

Installation instructions, accessories

Volvo Car Corporation Gothenburg, Sweden

9

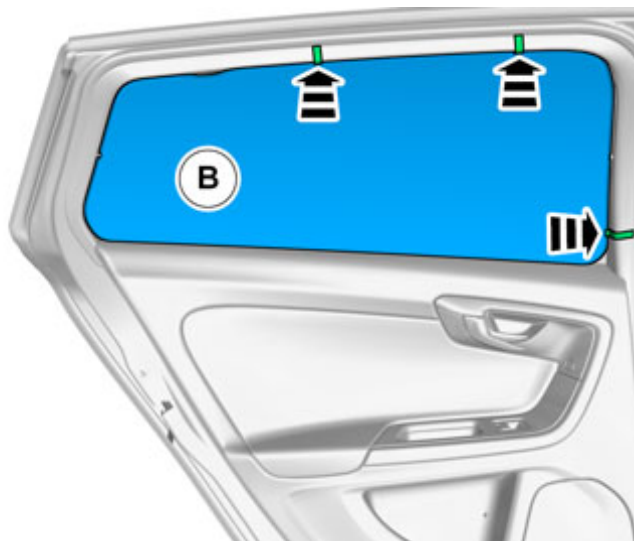

IMG-381689

Note!

The part must be bent during installation.

10

Repeat the steps when installing accessories on opposite side.

IMG-377070