

Installation instructions, accessories

Volvo Car Corporation Gothenburg, Sweden

Instruction No 31316439 **Version** 1.0 **Part. No.** 31659506, 30758116, 31373593, 31399365

Mirror, cover

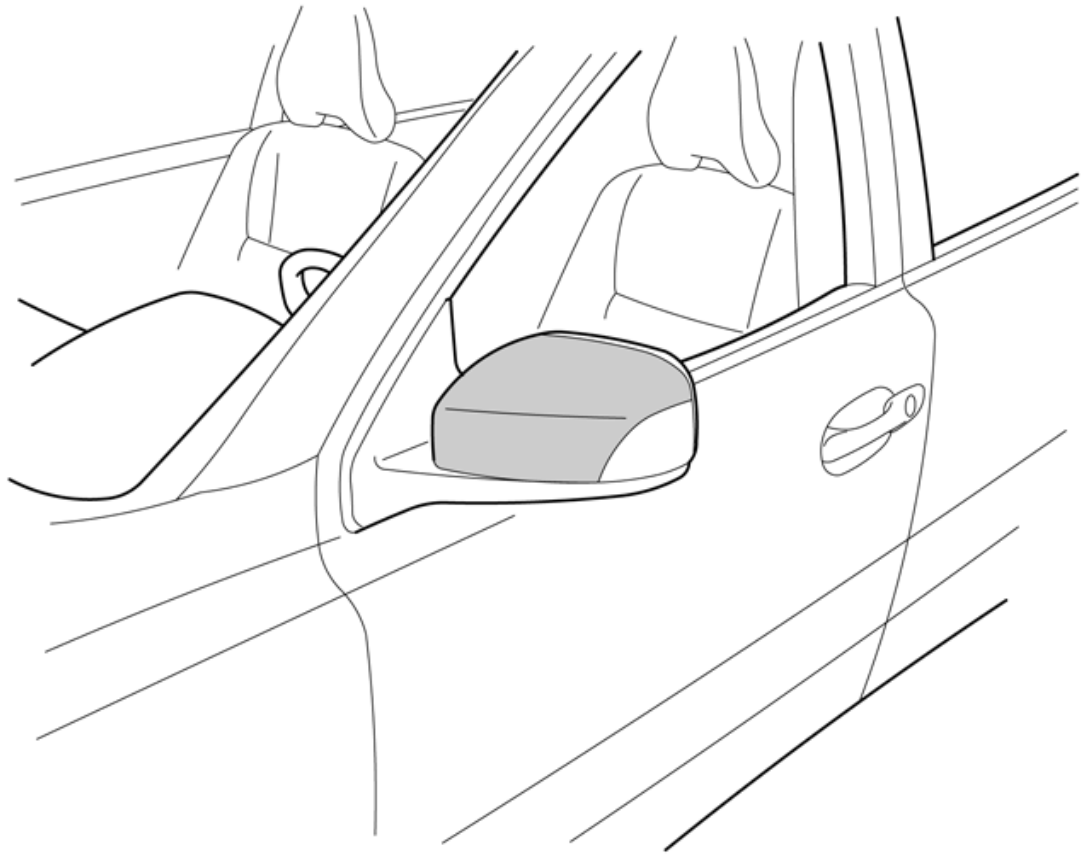

IMG-299403

Equipment

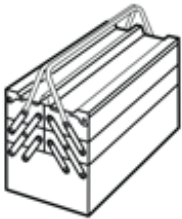

A0000162



IMG-336981

Installation instructions, accessories

Volvo Car Corporation Gothenburg, Sweden

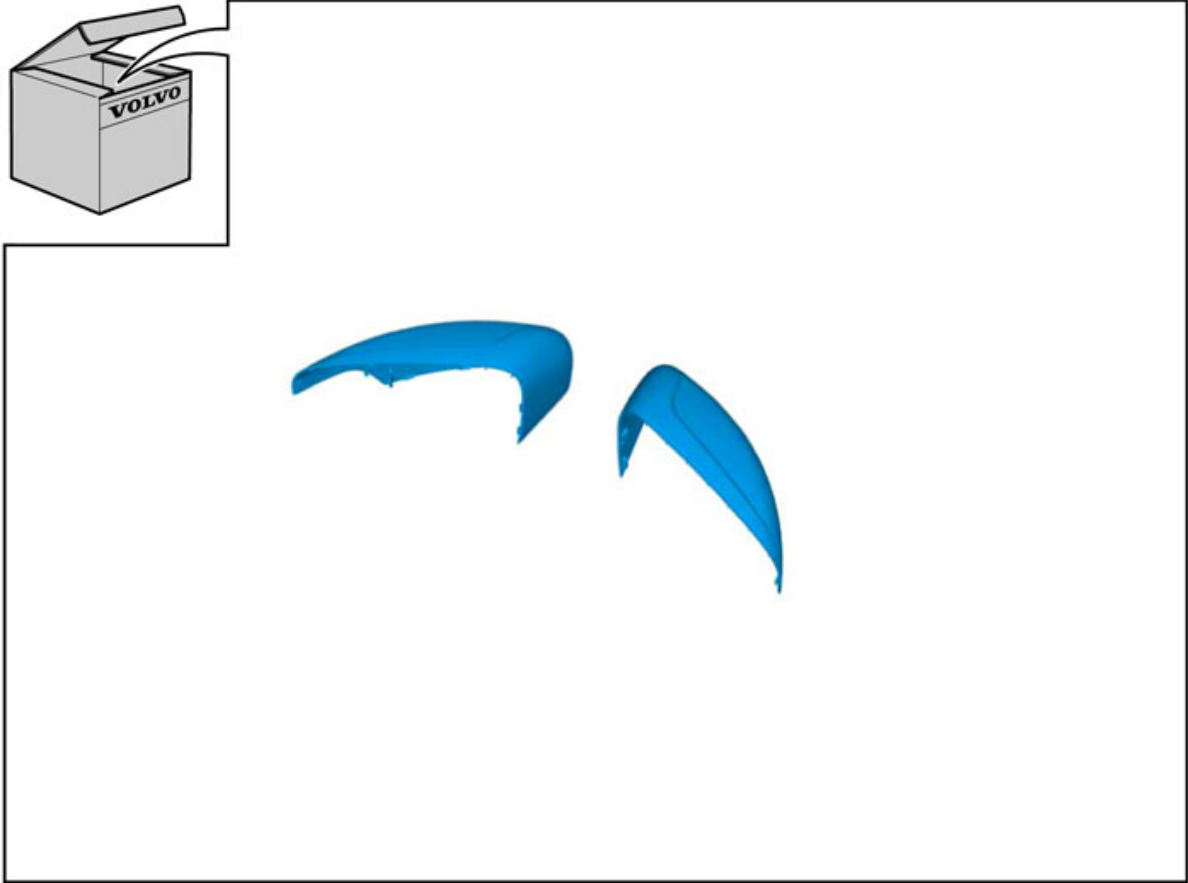

IMG-336982

Installation instructions, accessories

Volvo Car Corporation Gothenburg, Sweden

INTRODUCTION

Read through all of the instructions before starting installation.

Notifications and warning texts are for your safety and to minimise the risk of something breaking during installation.

Ensure that all tools stated in the instructions are available before starting installation.

Certain steps in the instructions are only presented in the form of images. Explanatory text is also given for more complicated steps.

In the event of any problems with the instructions or the accessory, contact your local Volvo dealer.

1

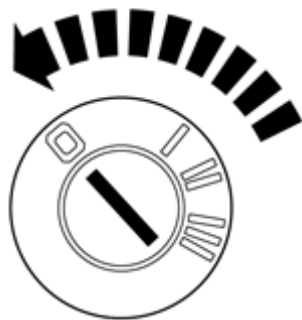

IMG-245980

Applies to all models

Turn the ignition key to position 0.

Note!

Wait at least three minutes before unplugging the connectors or removing other electrical equipment.

2

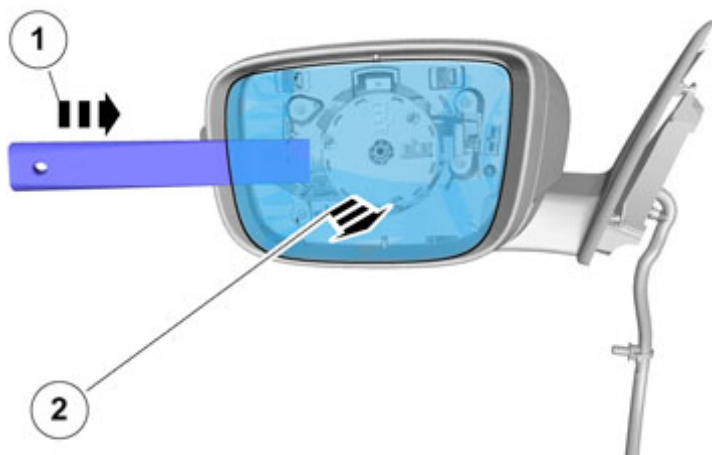

IMG-334091

Applies to the XC60

Carefully push the mirror glass out using the wedge shaped special tool part no. 9997390.

Remove the cover. New cover is included in the kit.

Installation instructions, accessories

Volvo Car Corporation Gothenburg, Sweden

3

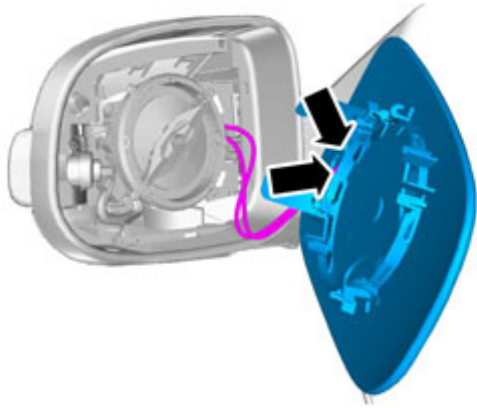

Disconnect the cables.

IMG-228990

Installation instructions, accessories

Volvo Car Corporation Gothenburg, Sweden

4A

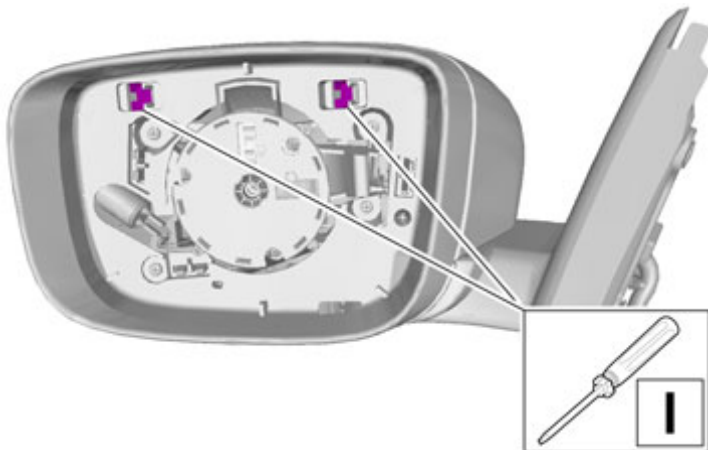

A, B, and C

Carefully pry off the catches and remove the cover. It will not be reused.

Repeat on the car's other side.

IMG-299503

4B

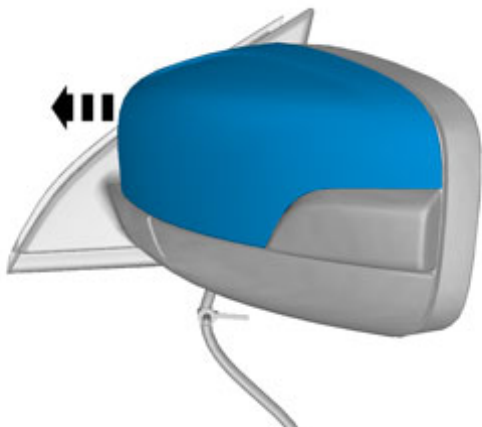

IMG-299504

4C

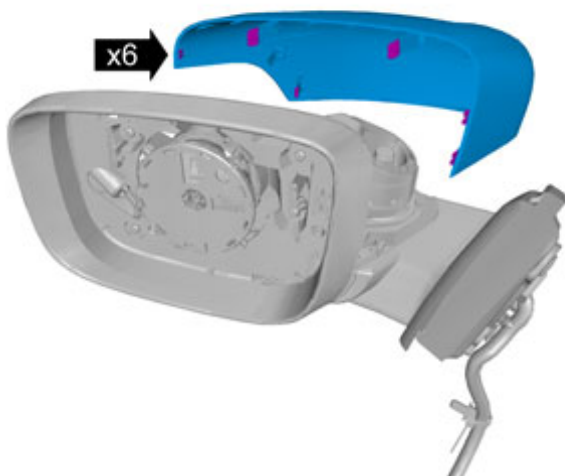

IMG-299505

Installation instructions, accessories

Volvo Car Corporation Gothenburg, Sweden

5A

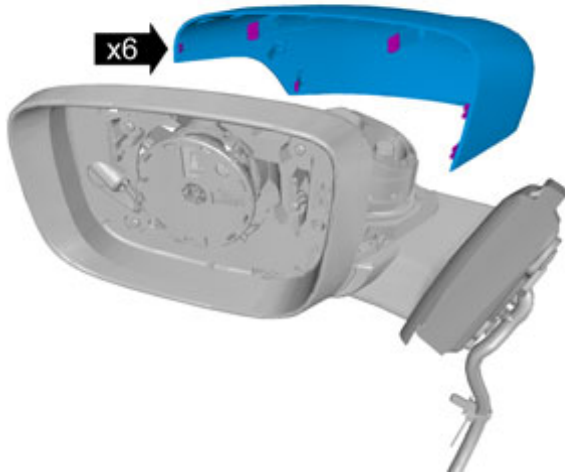

IMG-299505

5B

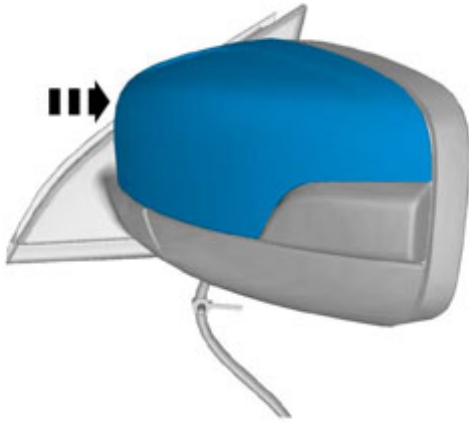

IMG-336988

Illustrations A and B

Install the new panel from the kit.

6

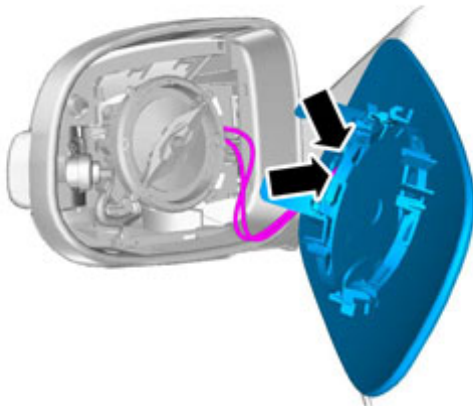

Connect the cables.

IMG-228990

Installation instructions, accessories

Volvo Car Corporation Gothenburg, Sweden

7

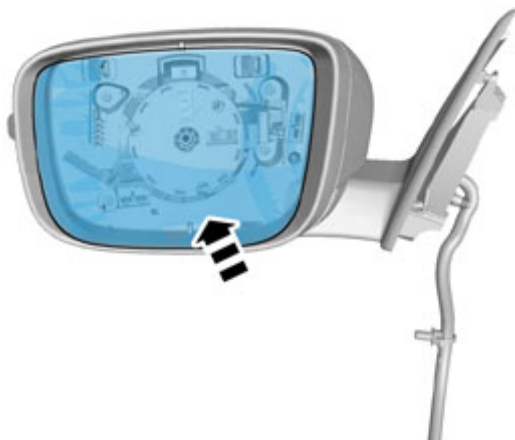

Carefully press the mirror glass into place.

Repeat for the other side.

IMG-336989

8

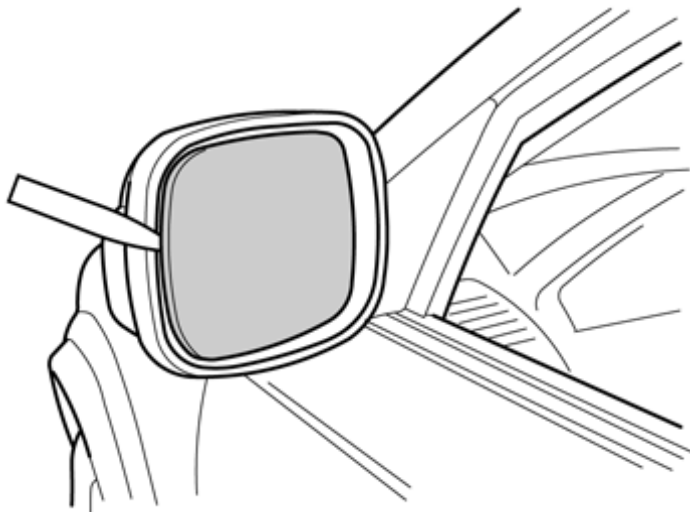

Applies to C30/C70 (06-)/S40 (04-)/V50/V70 (08-)/ XC70 (08-)/XC90

Carefully pry off the mirror glass.

IMG-299423

Installation instructions, accessories

Volvo Car Corporation Gothenburg, Sweden

9

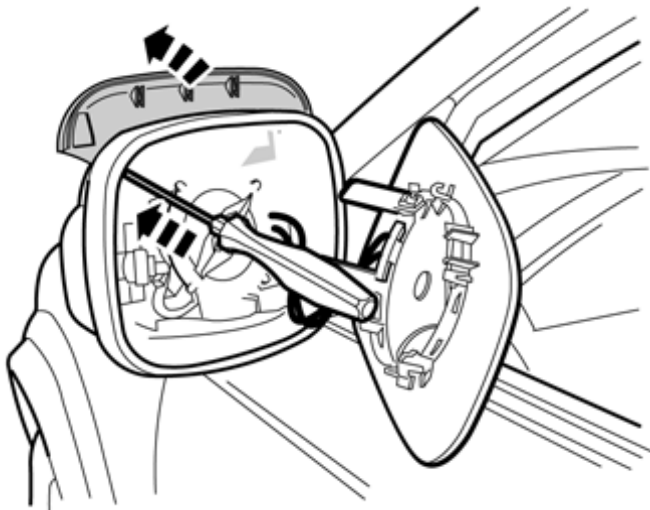

IMG-299443

Press out the mirror's cover using a small screwdriver.

Remove the cover. New cover is included in the kit.

10

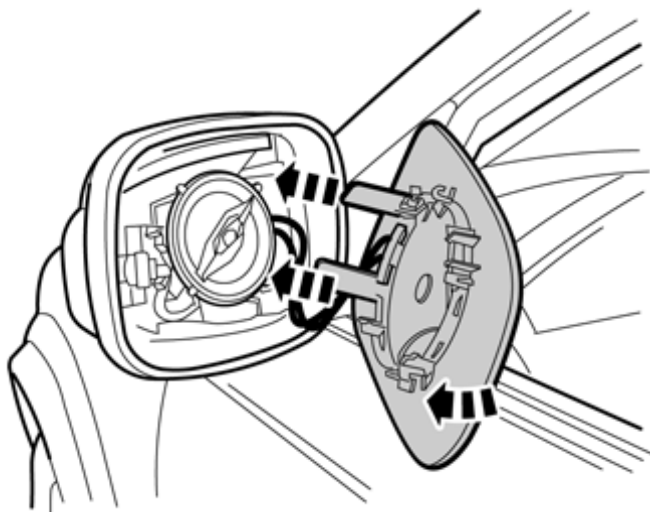

IMG-299444

Make sure that the damper blades end up in their grooves.

Carefully press the mirror glass into place.

Installation instructions, accessories

Volvo Car Corporation Gothenburg, Sweden

11A

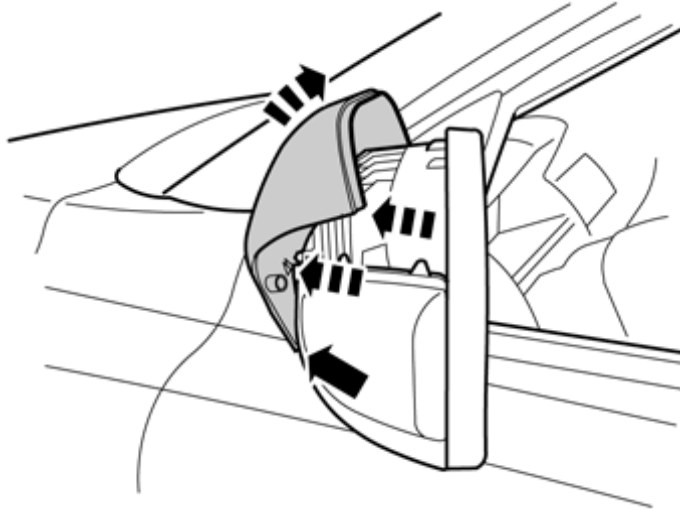

IMG-299445

11B

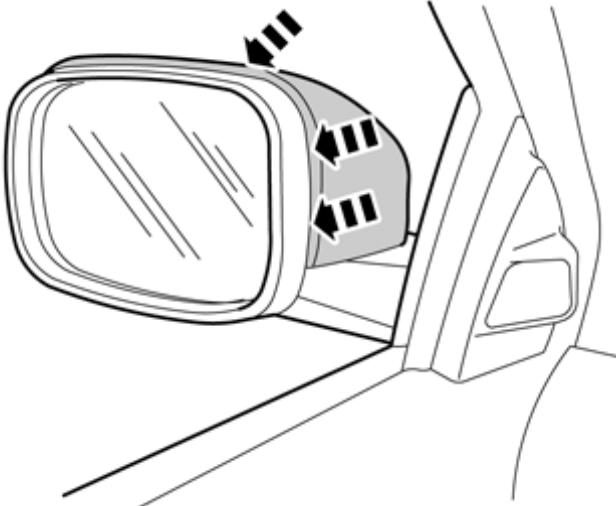

IMG-299446

11C

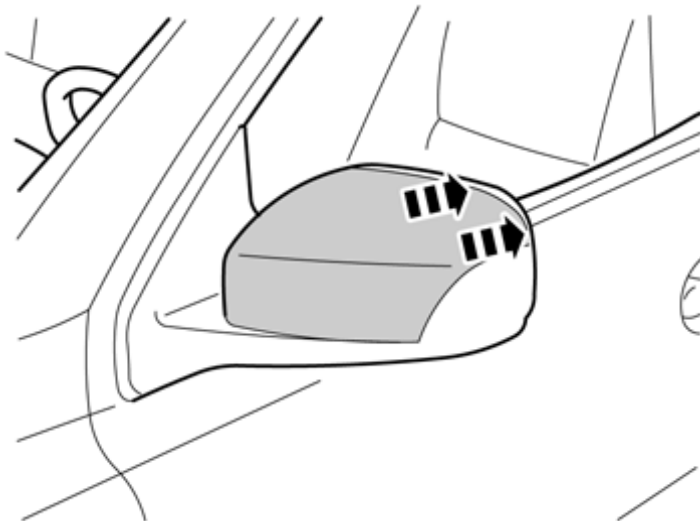

IMG-299447

Illustrations A, B and C

Press the new cover on the mirror. Press all the way around so that all catches engage.