



Installation instructions, accessories

Volvo Car Corporation Gothenburg, Sweden

Instrução n.º
31346082

Versão
1.0

Peça N.º
31407107, 31346554, 31350479

Barra de reboque, módulo de comando TRM



Installation instructions, accessories

Volvo Car Corporation Gothenburg, Sweden

Equipamento

VIDA

IMG-242205

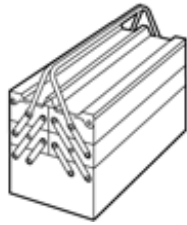

IMG-345497



IMG-332314

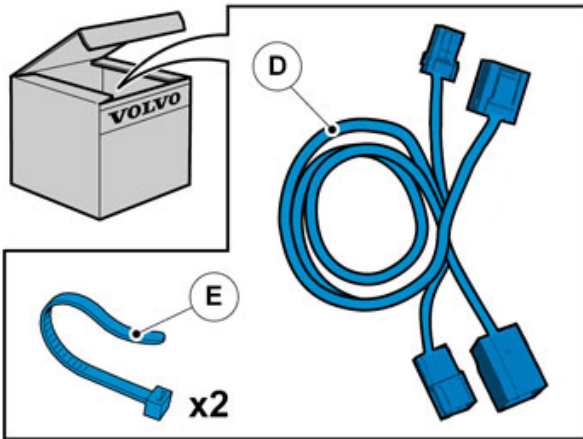
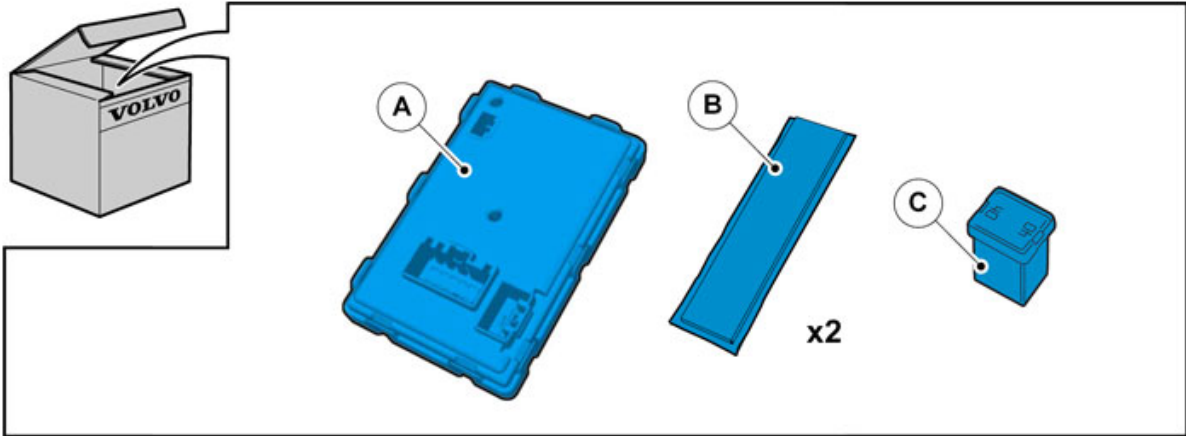

IMG-360181



Installation instructions, accessories

Volvo Car Corporation Gothenburg, Sweden

INTRODUÇÃO

Leia completamente as instruções antes de iniciar a instalação.

As notas e textos de advertência têm em vista a sua segurança e servem para minimizar o risco de que algo de danifique na instalação.

Certifique-se de que todas as ferramentas indicadas nas instruções se encontram disponíveis antes de iniciar a instalação.

Algumas fases das instruções são apresentadas apenas por imagens. Nas fases mais complicadas há também um texto explicativo.

Na eventualidade de problemas com as instruções ou com o acessório, consulte o concessionário local Volvo.

1



Rode a chave da ignição para a posição 0.

Nota!

Espere pelo menos um minuto antes de desligar os conectores, ou de retirar qualquer outro equipamento eléctrico.

IMG-245980



Installation instructions, accessories

Volvo Car Corporation Gothenburg, Sweden

2

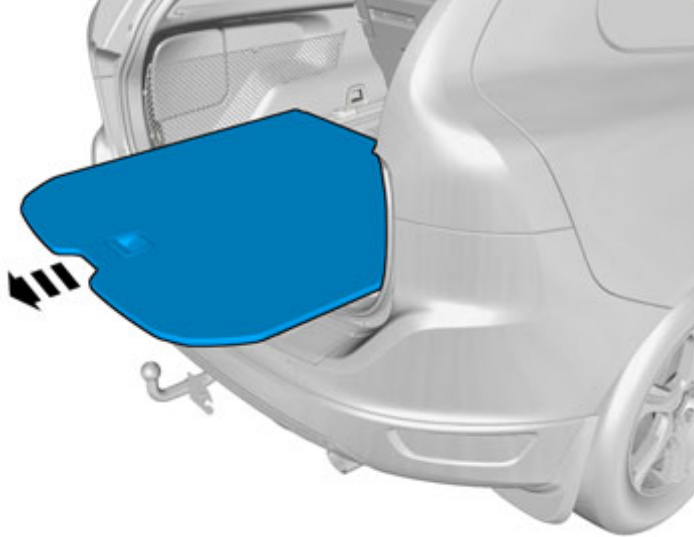

IMG-346921

3



IMG-346811



Installation instructions, accessories

Volvo Car Corporation Gothenburg, Sweden

4



IMG-360187

5

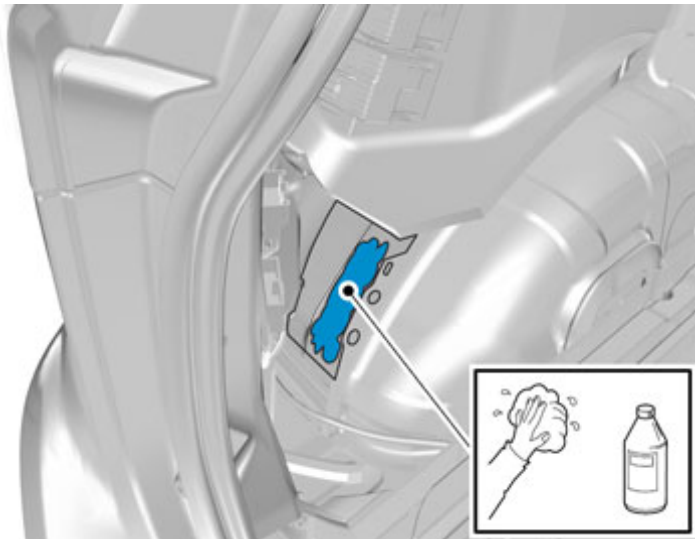

IMG-362267

Utilize: Isopropanol, referência 116172

Limpe até secar.



Installation instructions, accessories

Volvo Car Corporation Gothenburg, Sweden

6

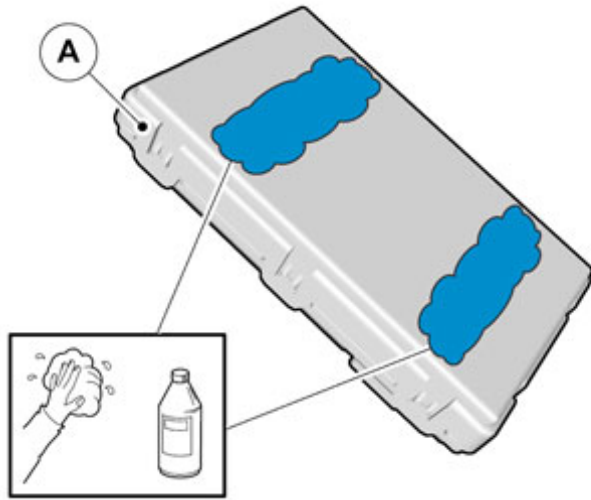

IMG-356179

Utilize: Isopropanol, referência 1161721

Limpe até secar.

7

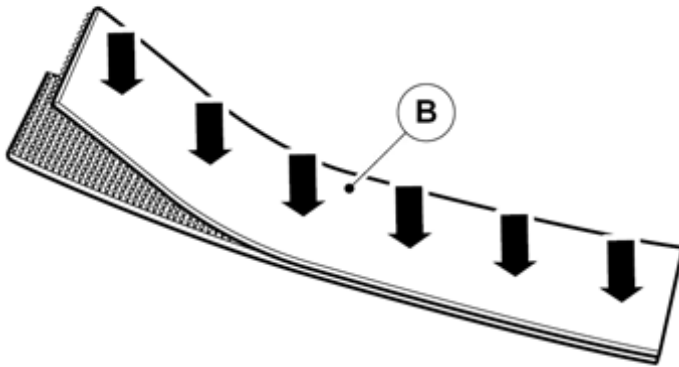

IMG-356181



Installation instructions, accessories

Volvo Car Corporation Gothenburg, Sweden

8

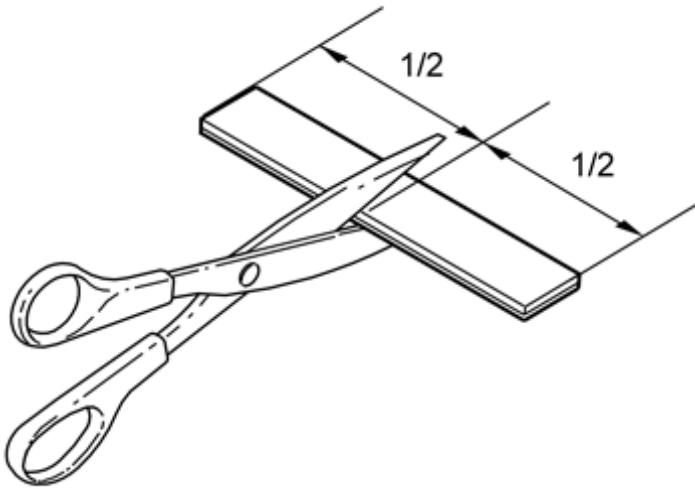

IMG-222282

9

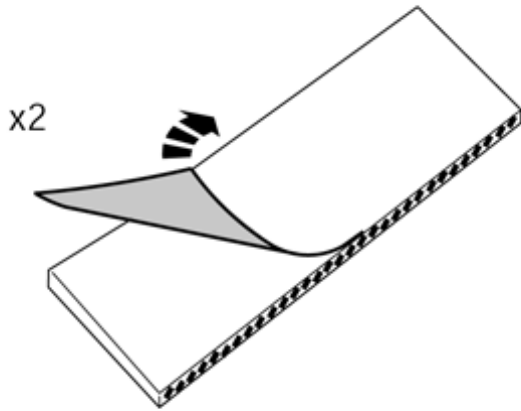

IMG-241925



Installation instructions, accessories

Volvo Car Corporation Gothenburg, Sweden

10

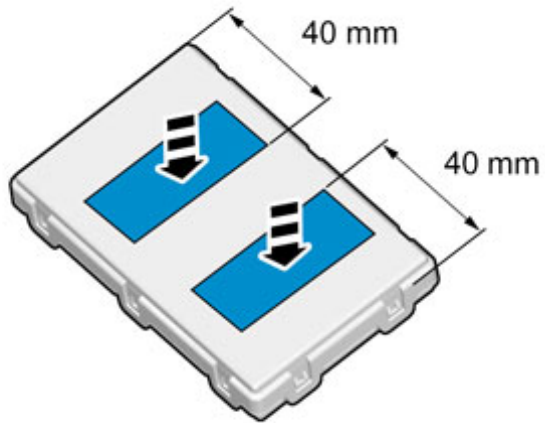

Ao instalar a fita de velcro a base deve estar a um temperatura mínima de +20° C (68°F).

IMG-356351

11

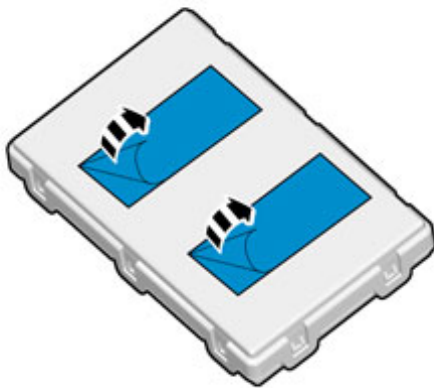

IMG-356352



Installation instructions, accessories

Volvo Car Corporation Gothenburg, Sweden

12

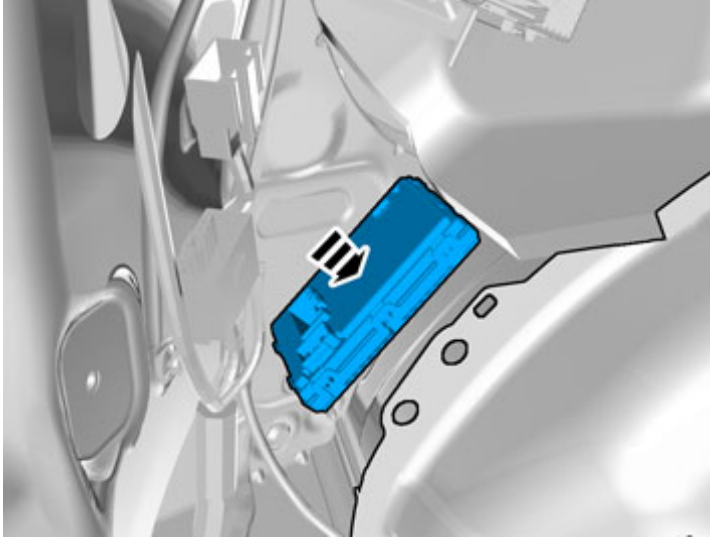

IMG-362292

Pressione o módulo no respectivo lugar.

Ao instalar a fita de velcro a base deve estar a um temperatura mínima de +20° C (68°F).

13

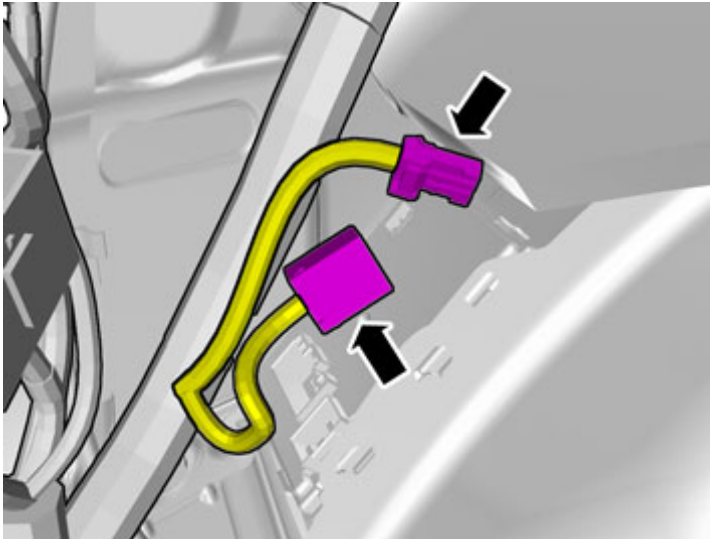

IMG-362298

Aplica-se a automóveis com ano de modelo a partir de 2013-

Localize os conectores na linha de cabos do automóvel.



Installation instructions, accessories

Volvo Car Corporation Gothenburg, Sweden

14

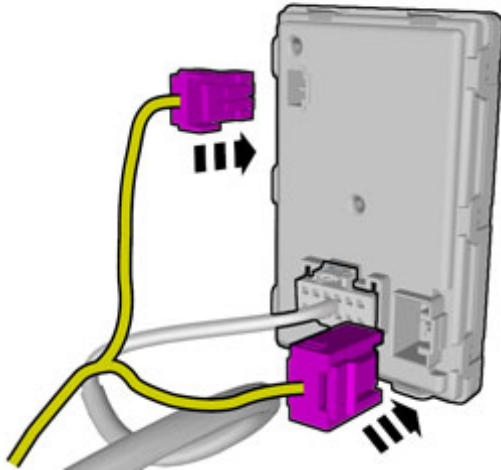

IMG-362296

Ligue os conectores localizados.

15

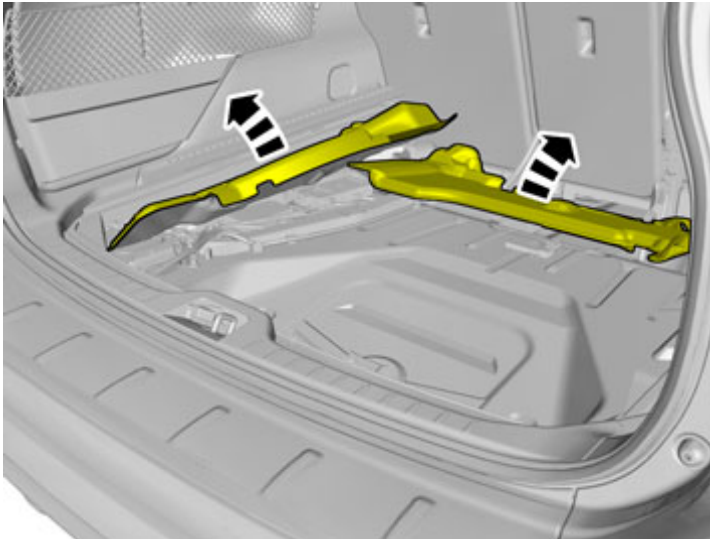

IMG-347027

Aplica-se a automóveis com ano de modelo até -2012

Afaste o isolamento.



Installation instructions, accessories

Volvo Car Corporation Gothenburg, Sweden

16

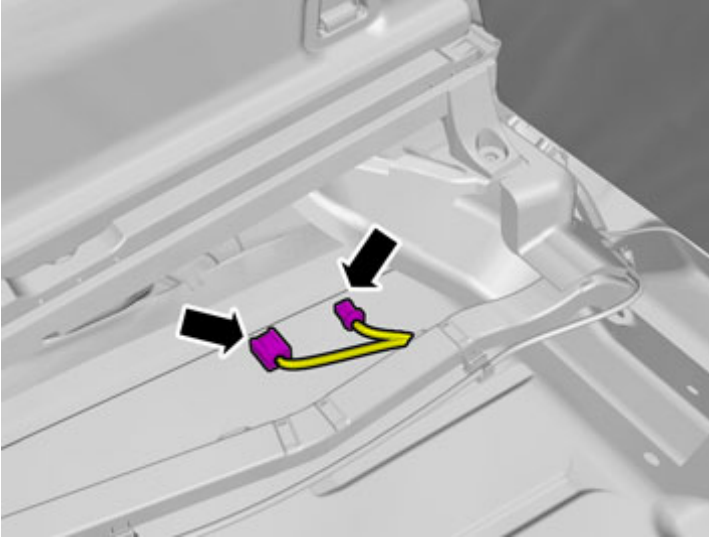

IMG-362307

Localize os conectores.

17

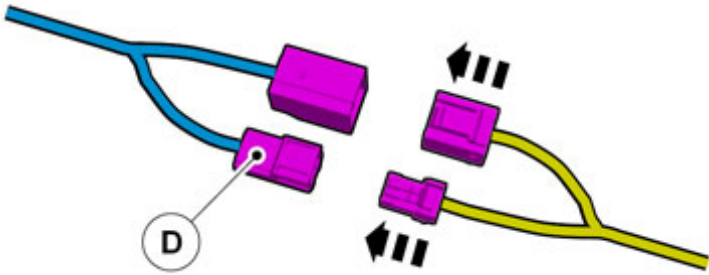

IMG-360183

Ligue a cablagem de extensão ao conector localizado.



Installation instructions, accessories

Volvo Car Corporation Gothenburg, Sweden

18

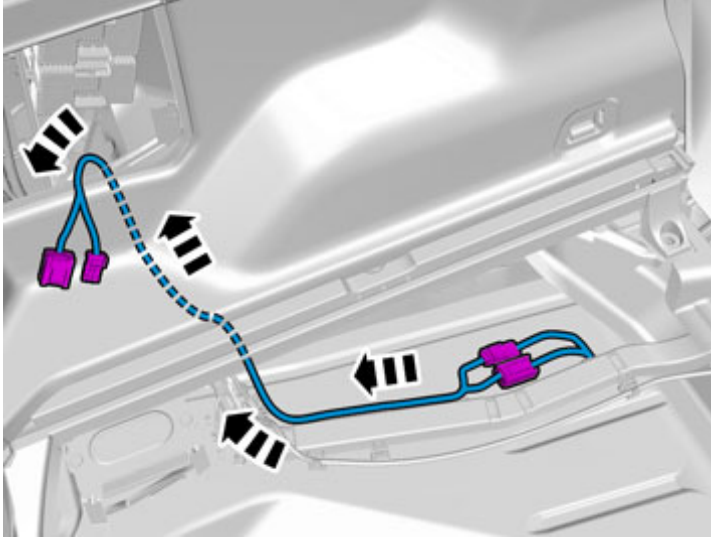

IMG-362318

Encaminhe a cablagem de extensão ao longo da cablagem existente.

19

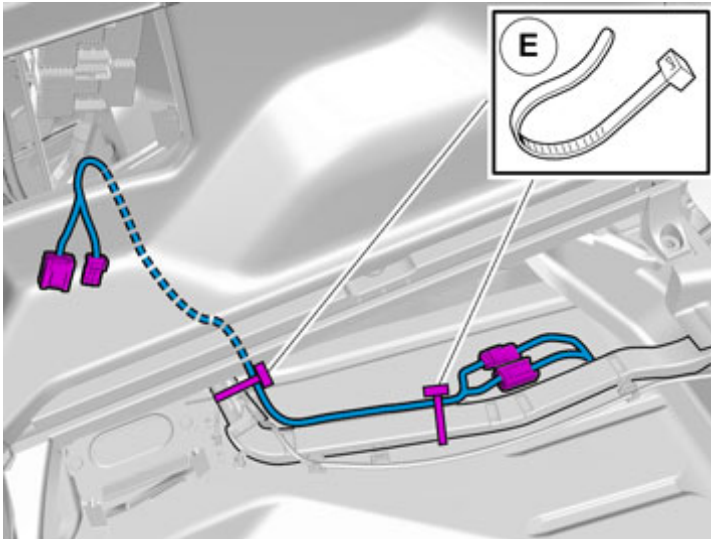

IMG-362319

Encaminhe a cablagem de extensão ao longo da cablagem existente.

Utilize braçadeiras para prender eventuais excedentes.



Installation instructions, accessories

Volvo Car Corporation Gothenburg, Sweden

20

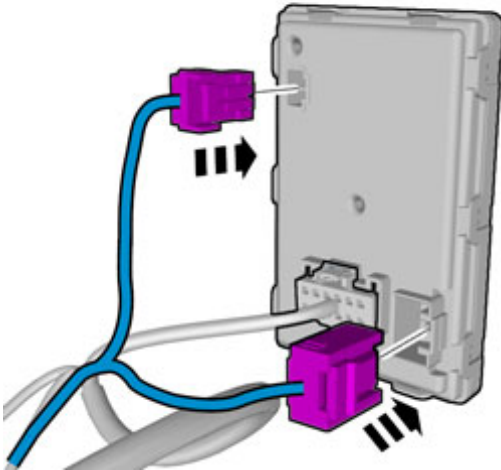

IMG-359922

Ligue os conectores da cablagem de extensão ao módulo de comando.

21

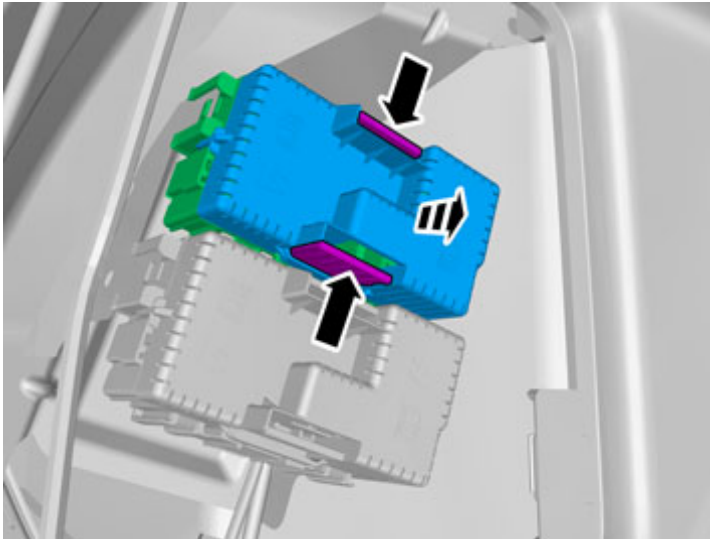

IMG-360189

Aplica-se a todos os modelos

Comprima os trincos da tampa preta no suporte dos fusíveis e retire-a.



Installation instructions, accessories

Volvo Car Corporation Gothenburg, Sweden

22

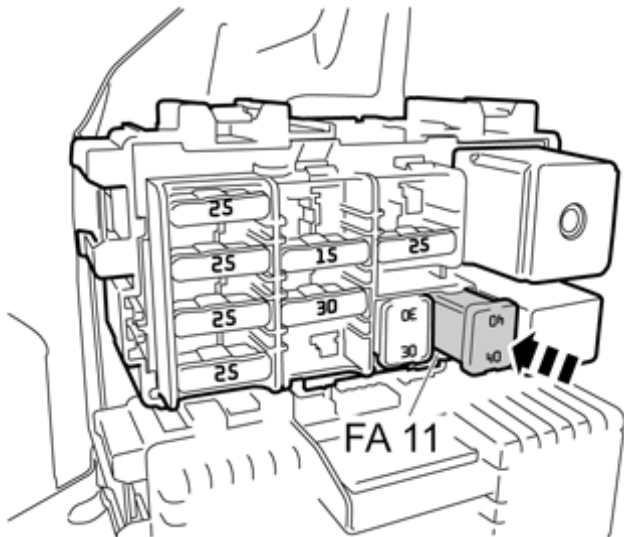

IMG-285841

Instale um fusível 40A na posição FA 11 no módulo RJB-A.

Volte a instalar a cobertura.

23

Volte a instalar os elementos soltos pela ordem inversa.

24

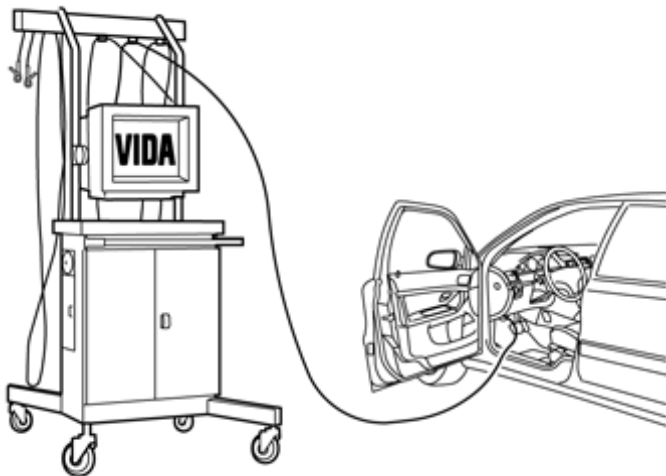

IMG-242268

Faça o download do software (aplicativo) para a função do acessório, segundo as informações de assistência do VIDA.

Ver no VIDA ou no catálogo de acessórios o número de referência do software.