

Installation instructions, accessories

Volvo Car Corporation Gothenburg, Sweden

Instruction No 31659162 **Version** 1.0 **Part. No.** 39842582, 39842581, 31470690

Sill molding, illuminated, front

Equipment

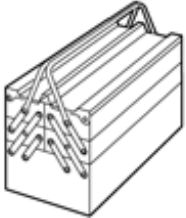

IMG-345497



IMG-239667

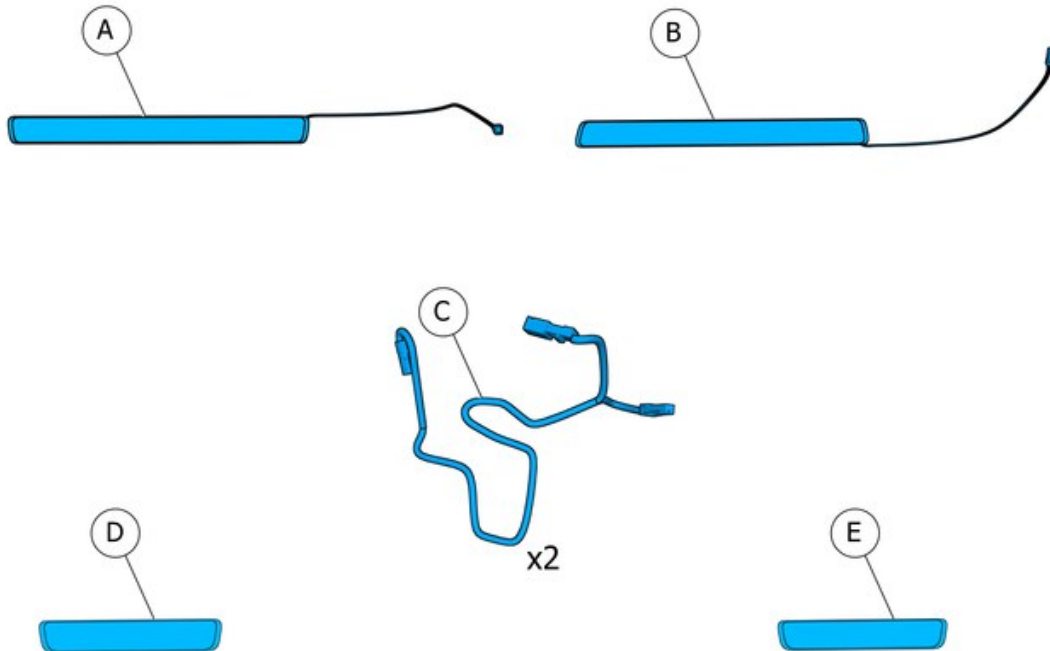

IMG-406595

Installation instructions, accessories

Volvo Car Corporation Gothenburg, Sweden

Information

1

Read through all of the instructions before starting installation.

Notifications and warning texts are for your safety and to minimise the risk of something breaking during installation.

Ensure that all tools stated in the instructions are available before starting installation.

Certain steps in the instructions are only presented in the form of images. Explanatory text is also given for more complicated steps.

In the event of any problems with the instructions or the accessory, contact your local Volvo dealer.

Color symbols

2

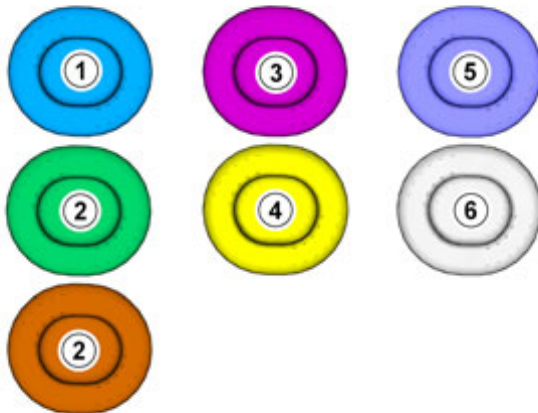

IMG-363036

Note!

This colour chart displays (in colour print and electronic version) the importance of the different colours used in the images of the method steps.

1. Used for focused component, the component with which you will do something.
 2. Used as extra colors when you need to show or differentiate additional parts.
 3. Used for attachments that are to be removed/installed. May be screws, clips, connectors, etc.
 4. Used when the component is not fully removed from the vehicle but only hung to the side.
 5. Used for standard tools and special tools.
 6. Used as background color for vehicle components.
-

Removal

Installation instructions, accessories

Volvo Car Corporation Gothenburg, Sweden

3

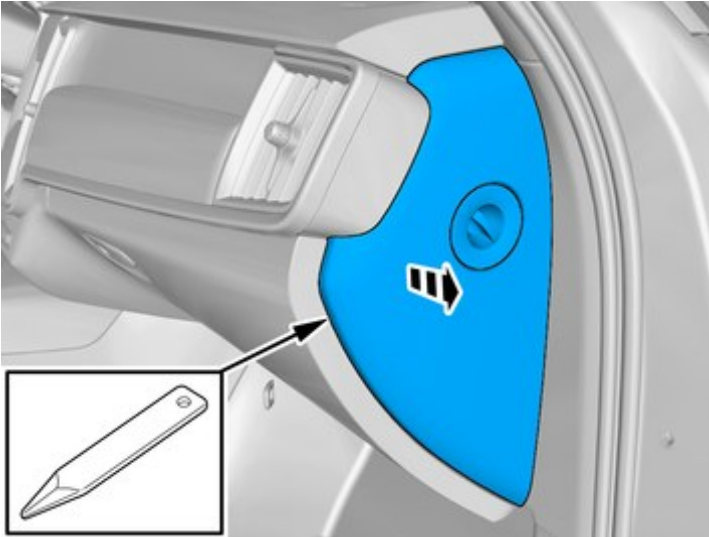

IMG-412242

Remove the panel.

Disconnect the connector, if applicable.

Repeat on the other side.

4

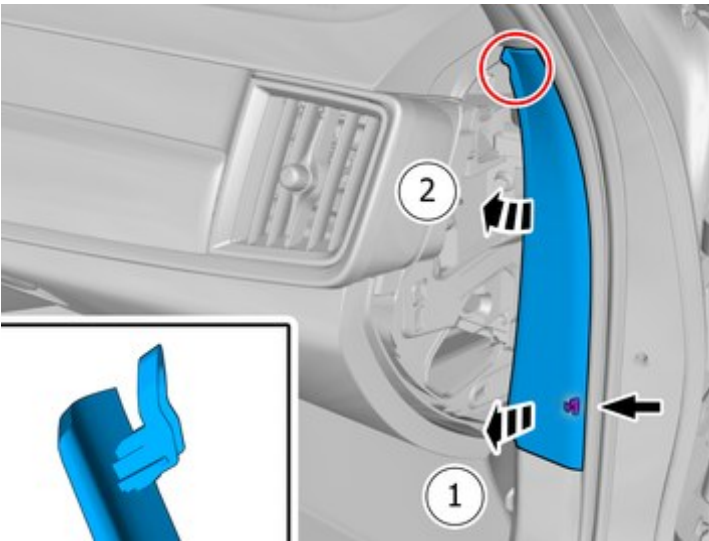

IMG-414575

Remove the panel.

Repeat on the other side.

Installation instructions, accessories

Volvo Car Corporation Gothenburg, Sweden

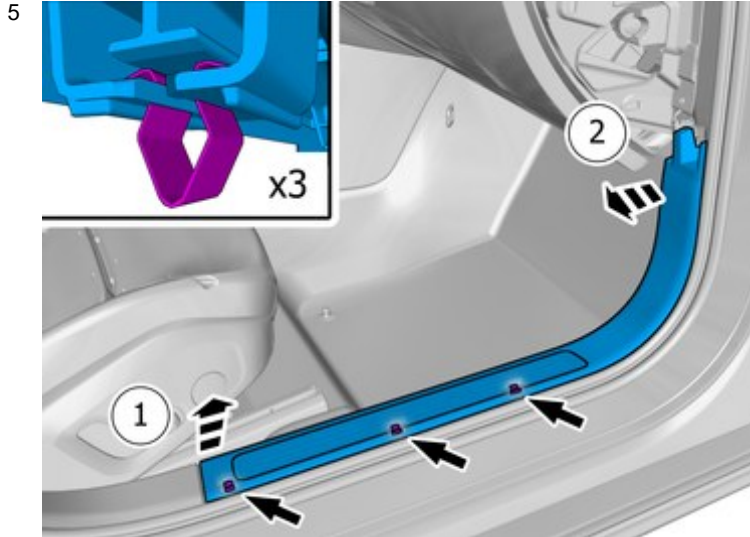

IMG-414580

Remove the panel.

Repeat on the other side.

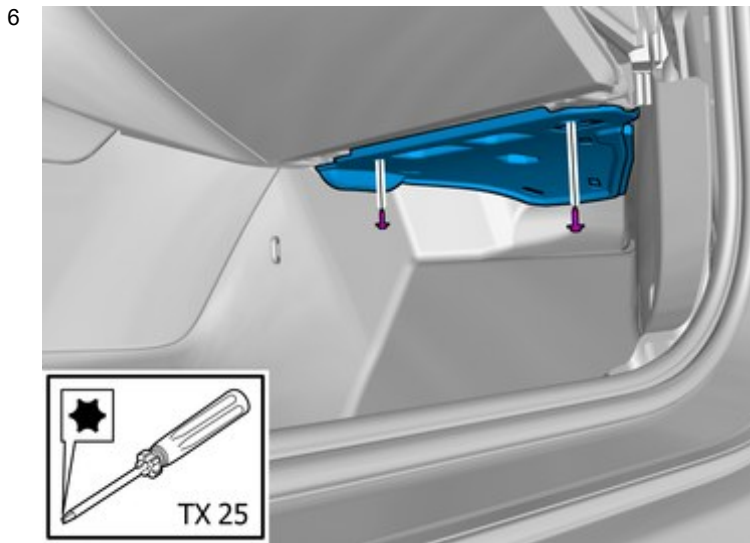

IMG-414585

Remove the screws.

Remove the panel.

Installation instructions, accessories

Volvo Car Corporation Gothenburg, Sweden

7

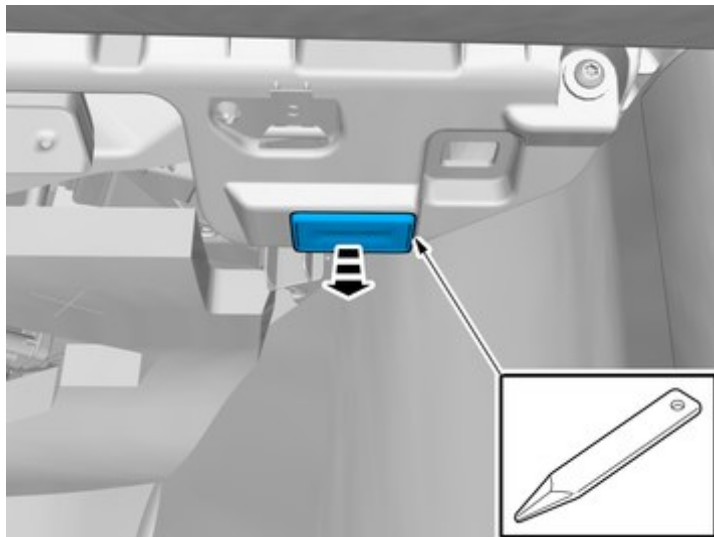

IMG-406626

Remove the marked part.

8

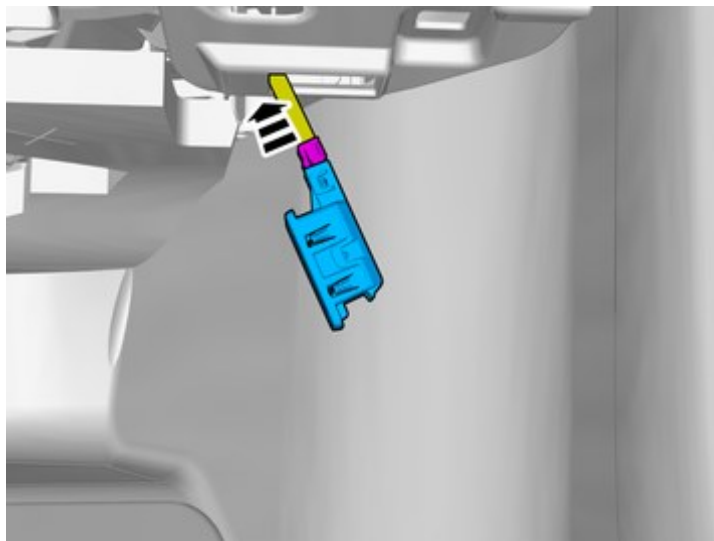

IMG-406628

Disconnect the connector.

Installation instructions, accessories

Volvo Car Corporation Gothenburg, Sweden

9

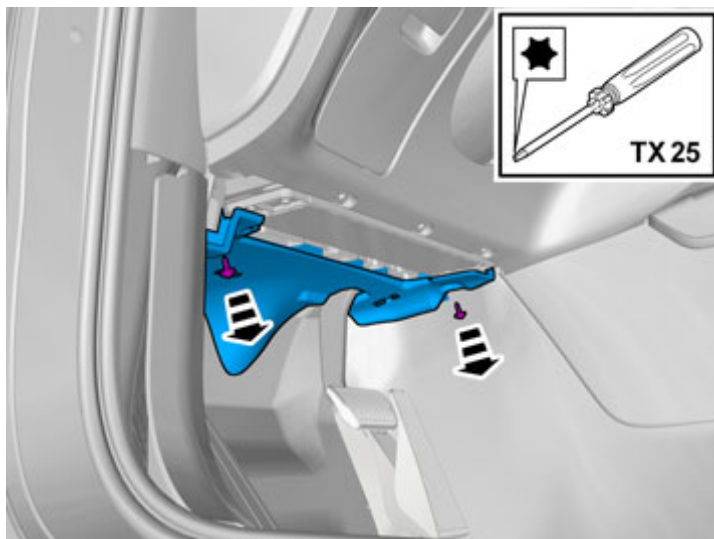

IMG-383314

Remove the screws.

Remove the panel.

10

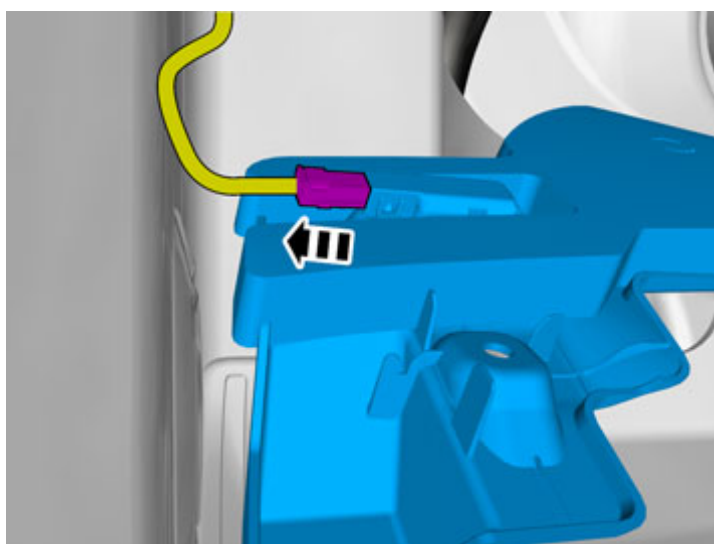

IMG-383315

Disconnect the connector.

Installation instructions, accessories

Volvo Car Corporation Gothenburg, Sweden

11

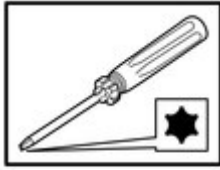

Remove the screws.

IMG-406875

12

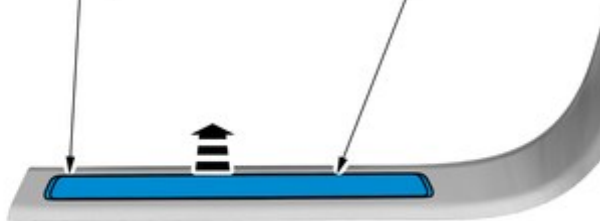

Remove the marked part.
The part is not to be reused.

IMG-406878

13

When removing on right-hand drive cars, perform the procedures on the opposite side and/or mirrored.

Accessory installation

Installation instructions, accessories

Volvo Car Corporation Gothenburg, Sweden

14

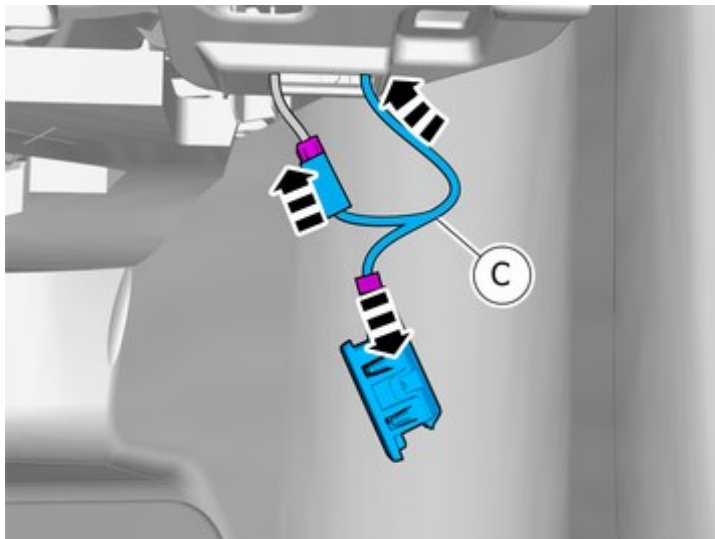

IMG-406925

Connect the connectors.

15

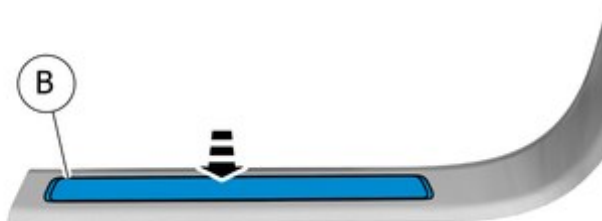

IMG-406879

Install component that comes with the accessory kit.

Installation instructions, accessories

Volvo Car Corporation Gothenburg, Sweden

16

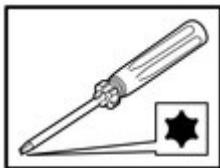

Install the screws.



IMG-406877

17

Install the connector to its attachment.



IMG-406885

Installation instructions, accessories

Volvo Car Corporation Gothenburg, Sweden

18

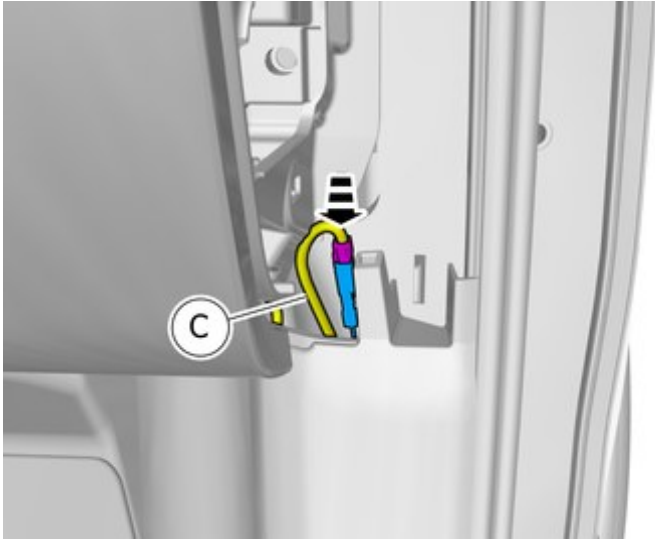

IMG-406926

Connect the connector.

19

Repeat the steps when installing accessories on opposite side.
Reinstall the removed parts in reverse order.

Removal

20

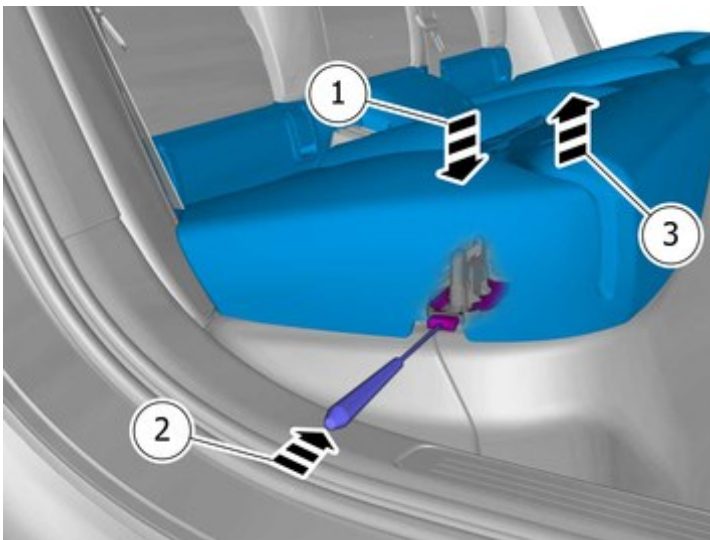

IMG-414411

Release the lock.
Repeat on the other side.
Remove the marked part.

Installation instructions, accessories

Volvo Car Corporation Gothenburg, Sweden

21



IMG-417200

22

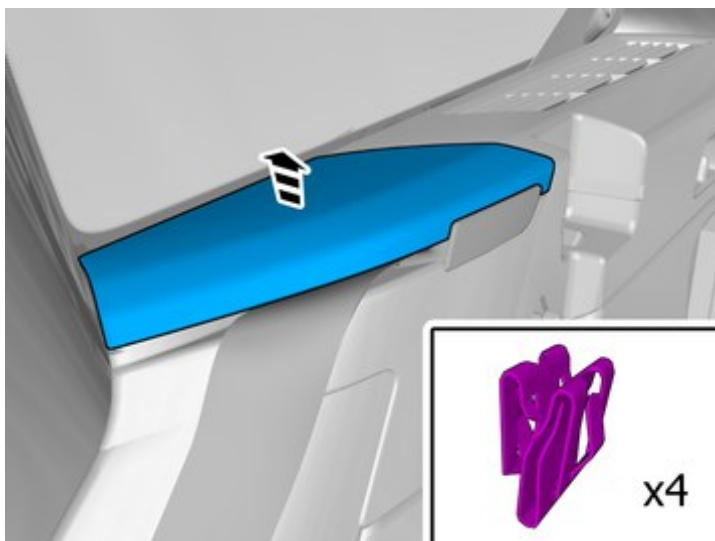

IMG-414614

Remove the panel.

Installation instructions, accessories

Volvo Car Corporation Gothenburg, Sweden

23

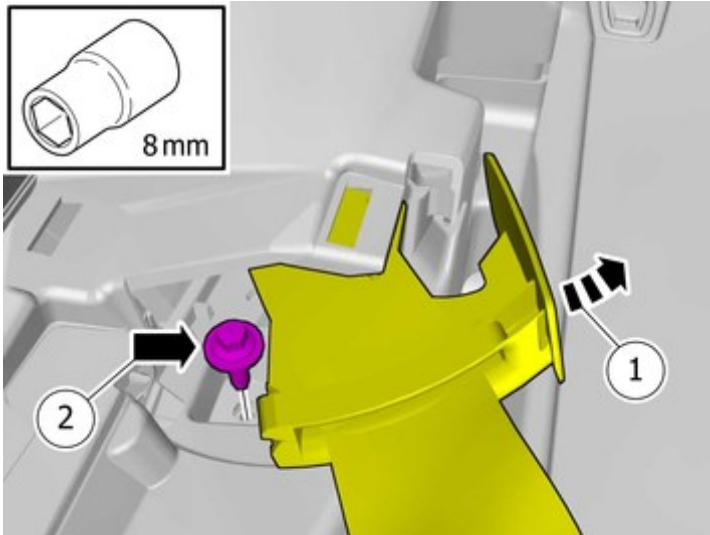

IMG-414995

1. Fold marked part aside.

2. Remove the screw.

3.

Tightening torque: Seat belt guide, to Bracket , 4.4 Nm

24

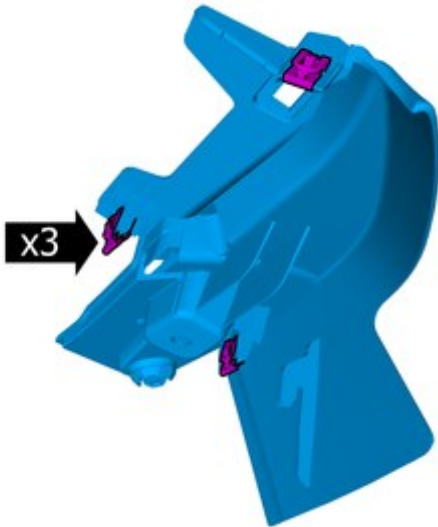

IMG-415046

Note!

The graphic shows the back of the component before removal.

Installation instructions, accessories

Volvo Car Corporation Gothenburg, Sweden

25

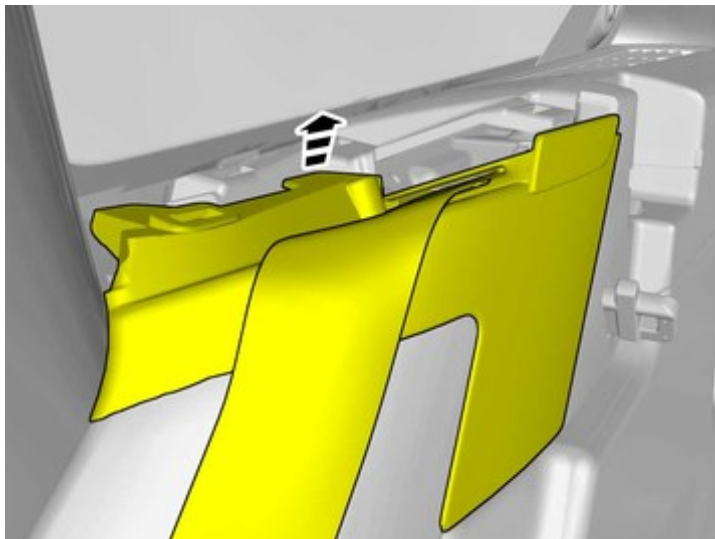

IMG-415047

Remove the part carefully

Fold marked part aside.

26

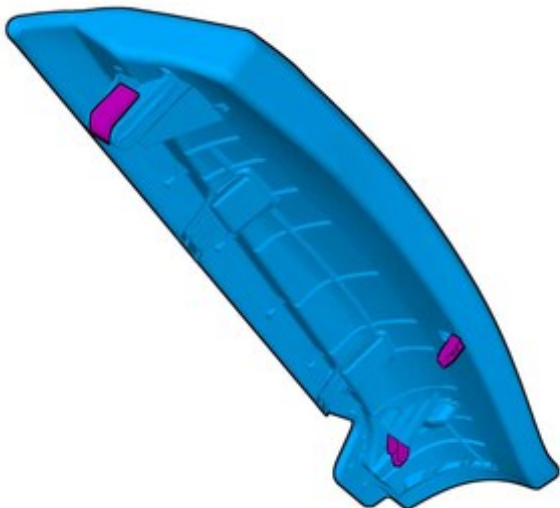

IMG-415048

Note!

The graphic shows the back of the component before removal.

Installation instructions, accessories

Volvo Car Corporation Gothenburg, Sweden

27

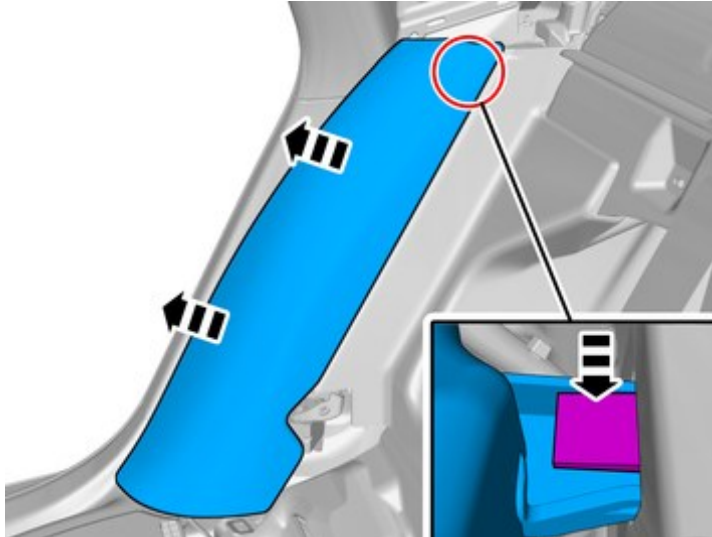

IMG-414478

Release the catch.

Remove the marked part.

28

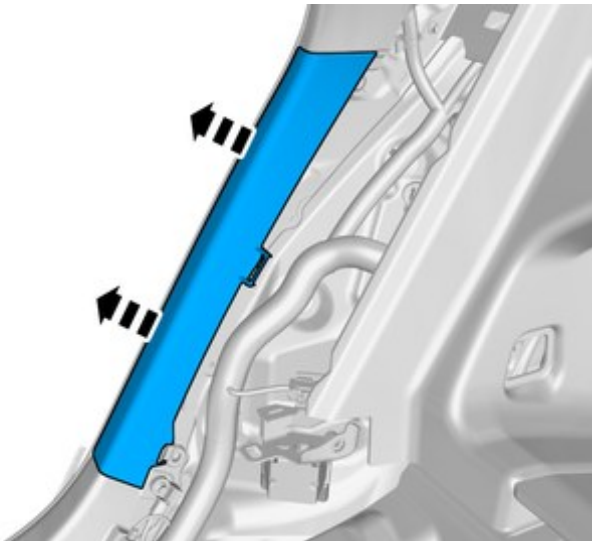

IMG-414482

Installation instructions, accessories

Volvo Car Corporation Gothenburg, Sweden

29

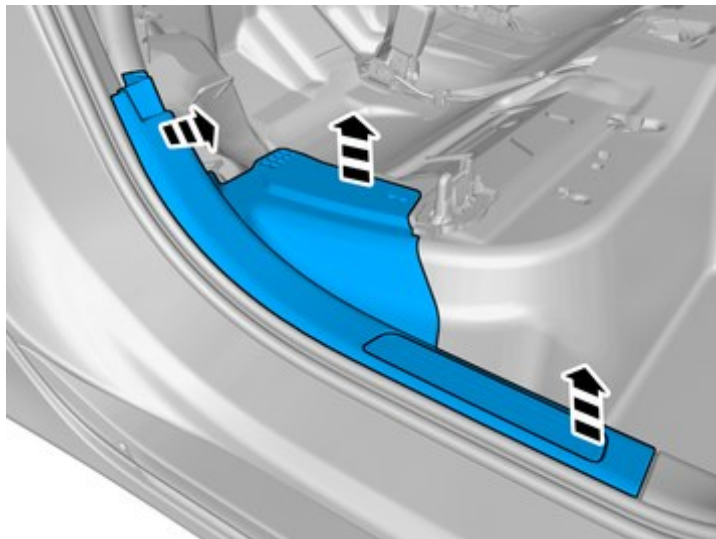

IMG-414483

Remove the panel.

30

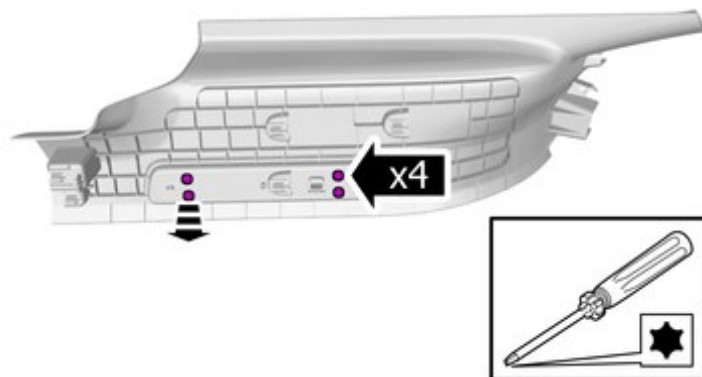

IMG-406635

Remove the screws.

The part is to be reused.

Installation instructions, accessories

Volvo Car Corporation Gothenburg, Sweden

31

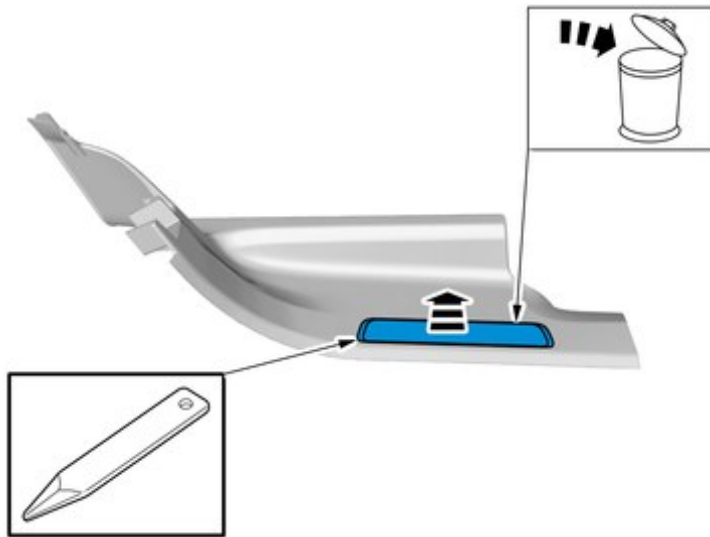

IMG-406637

Remove the marked part.
The part is not to be reused.

32

Repeat the steps when removing on opposite side.

Accessory installation

33

Install component that comes with the accessory kit.



IMG-406638

Installation instructions, accessories

Volvo Car Corporation Gothenburg, Sweden

34

Install the screws.

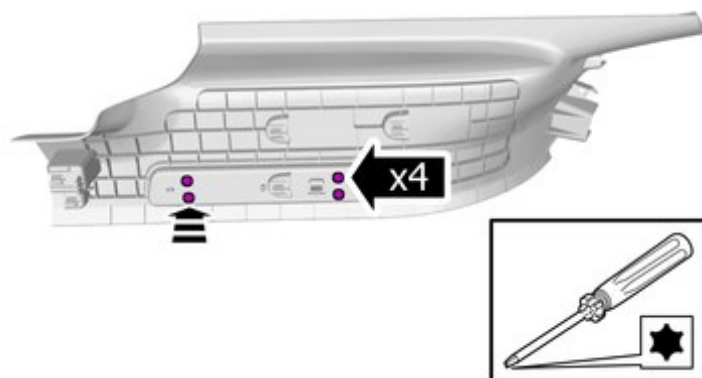

IMG-406636

35

Repeat the steps when installing on opposite side.

Reinstall the removed parts in reverse order.