

Installation instructions, accessories

Volvo Car Corporation Gothenburg, Sweden

Instruction No 31470358
Version 1.2
Part. No. 32270870, 32270871

Digital radio, DAB

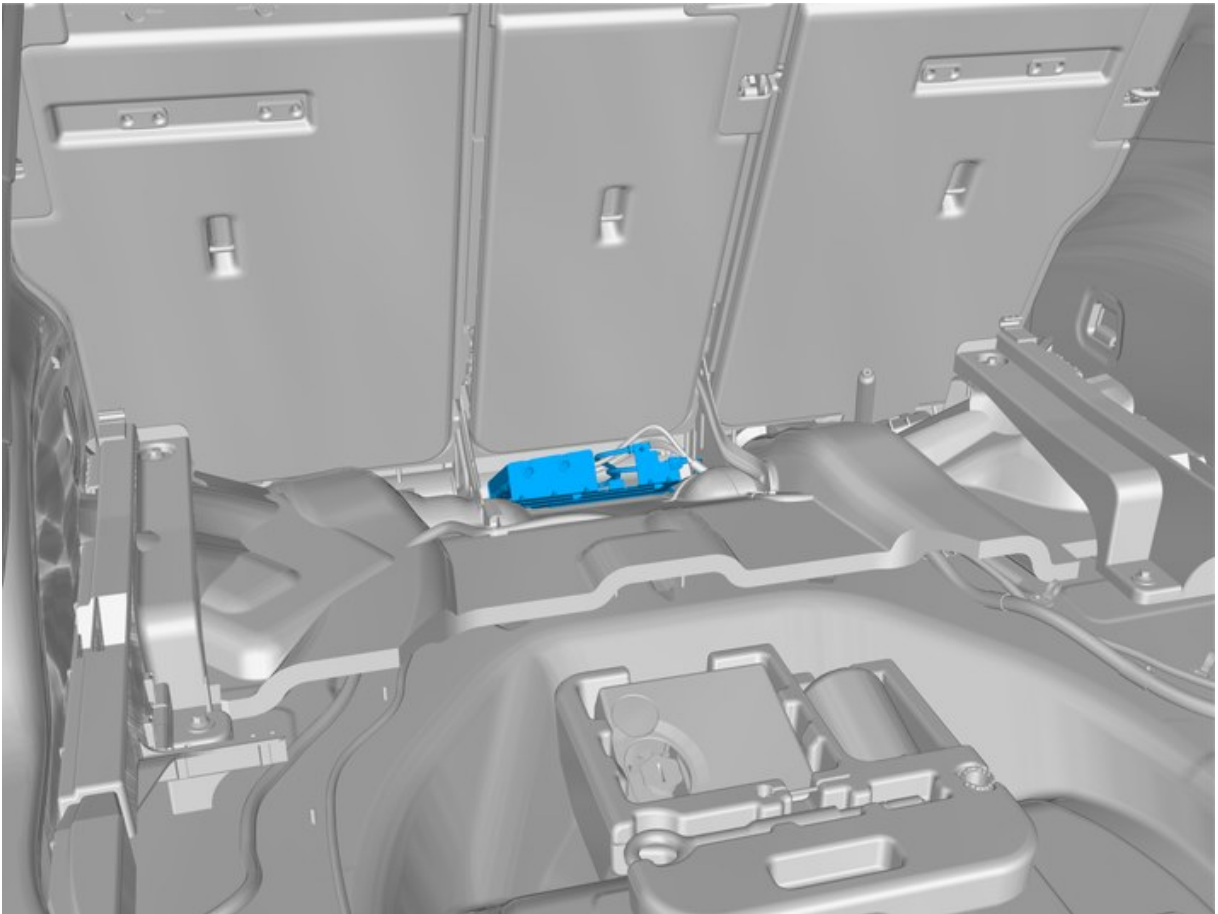

IMG-394921

Equipment

VIDA

IMG-242205

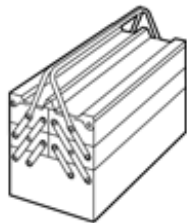

IMG-345497



IMG-239664

Nm
lbf.ft

Installation instructions, accessories

Volvo Car Corporation Gothenburg, Sweden

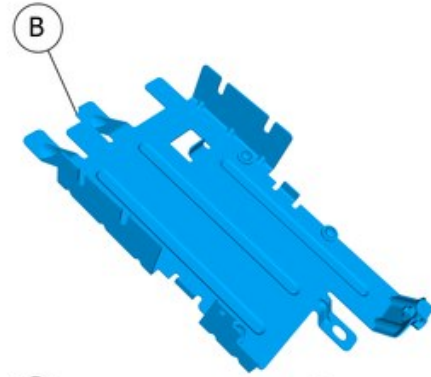
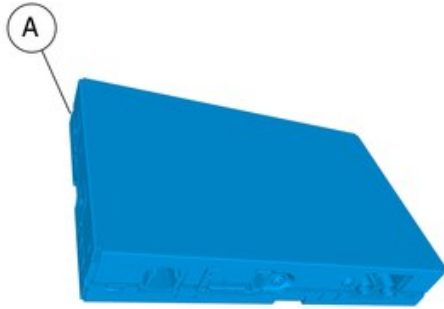

IMG-394782

Installation instructions, accessories

Volvo Car Corporation Gothenburg, Sweden

Information

1

Read through all of the instructions before starting installation.

Notifications and warning texts are for your safety and to minimise the risk of something breaking during installation.

Ensure that all tools stated in the instructions are available before starting installation.

Certain steps in the instructions are only presented in the form of images. Explanatory text is also given for more complicated steps.

In the event of any problems with the instructions or the accessory, contact your local Volvo dealer.

Color symbols

2

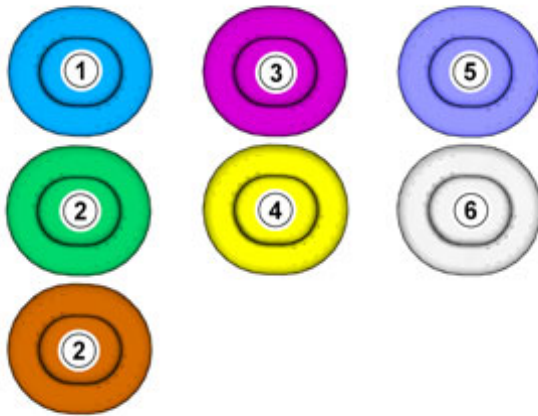

Note!

This colour chart displays (in colour print and electronic version) the importance of the different colours used in the images of the method steps.

1. Used for focused component, the component with which you will do something.
2. Used as extra colors when you need to show or differentiate additional parts.
3. Used for attachments that are to be removed/installed. May be screws, clips, connectors, etc.
4. Used when the component is not fully removed from the vehicle but only hung to the side.
5. Used for standard tools and special tools.
6. Used as background color for vehicle components.

IMG-363036

3

Set the ignition key to position 0.



IMG-332193

Installation instructions, accessories

Volvo Car Corporation Gothenburg, Sweden

Removal

4



IMG-395390

5



IMG-395396

Installation instructions, accessories

Volvo Car Corporation Gothenburg, Sweden

6

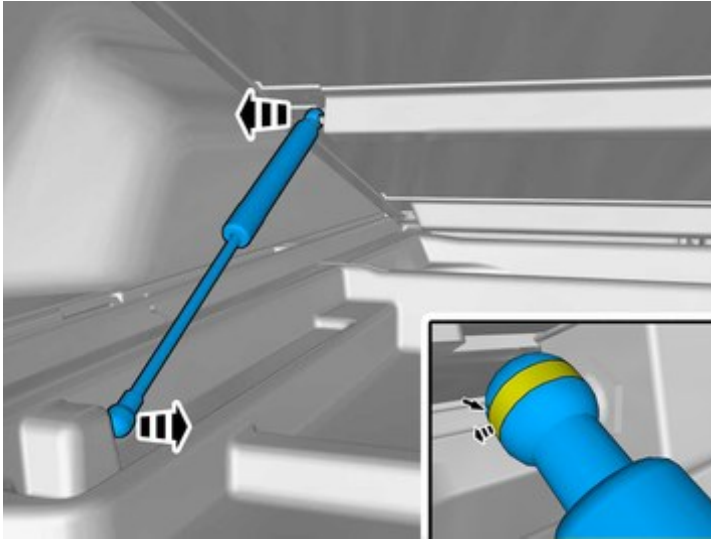

Remove the marked part.

7



IMG-395427

Installation instructions, accessories

Volvo Car Corporation Gothenburg, Sweden

8



IMG-395409

Accessory installation

9

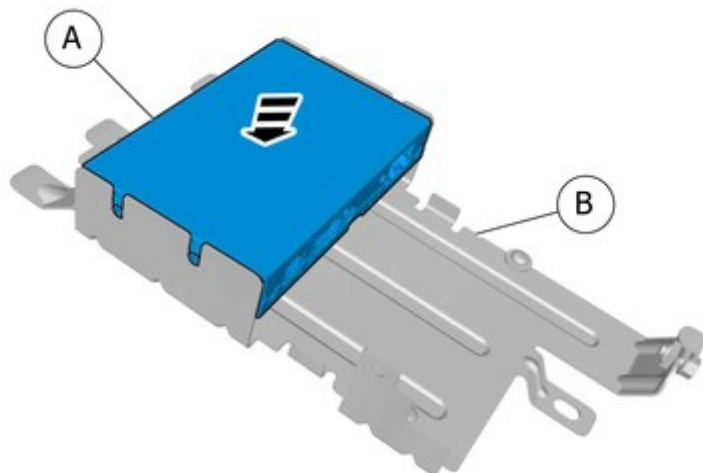

IMG-394788

Install component that comes with the accessory kit.

Installation instructions, accessories

Volvo Car Corporation Gothenburg, Sweden

10

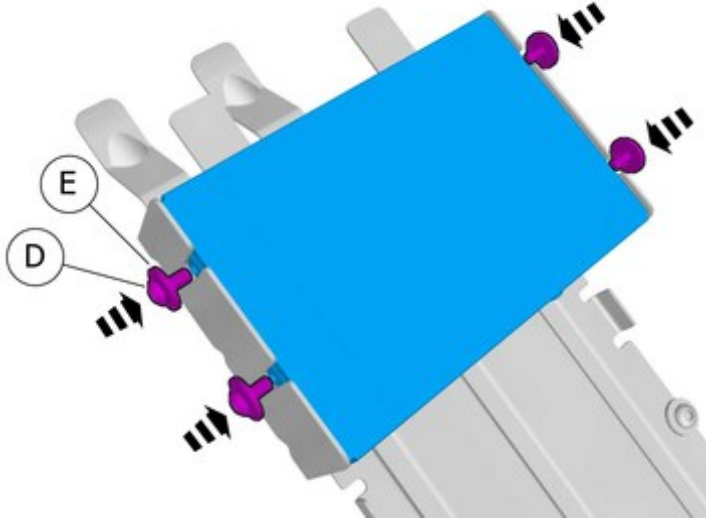

IMG-394790

Install component that comes with the accessory kit.

Install the screws.

11

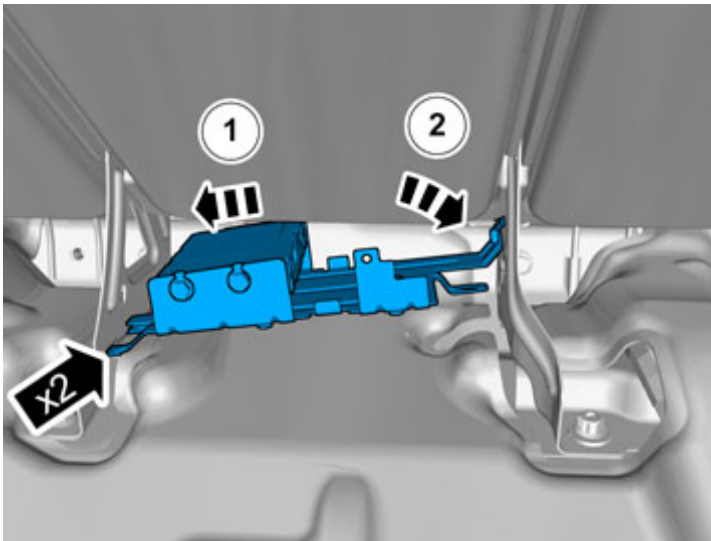

IMG-342320

Installation instructions, accessories

Volvo Car Corporation Gothenburg, Sweden

12

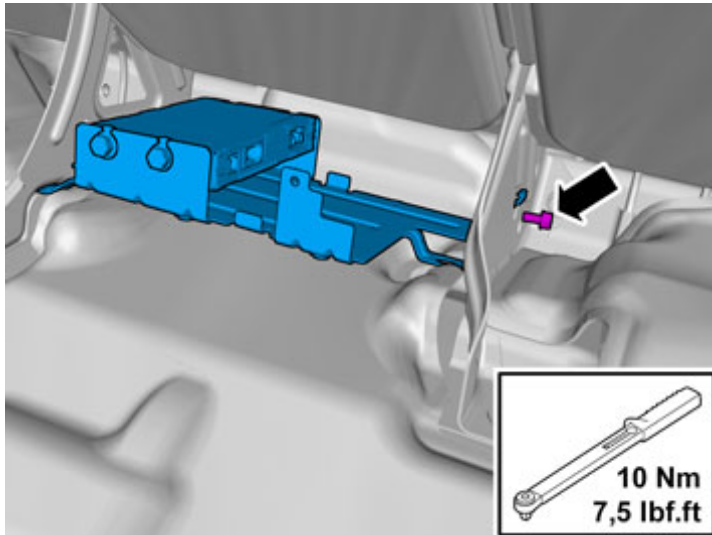

Tighten the screw.

Tightening torque: M6 , 10 Nm

13

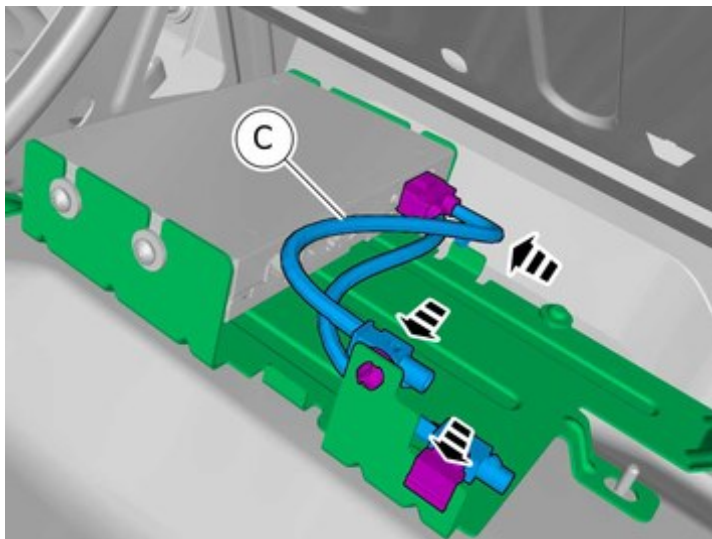

Install component that comes with the accessory kit.

Fasten the wiring harness using the existing clips.

Installation instructions, accessories

Volvo Car Corporation Gothenburg, Sweden

14

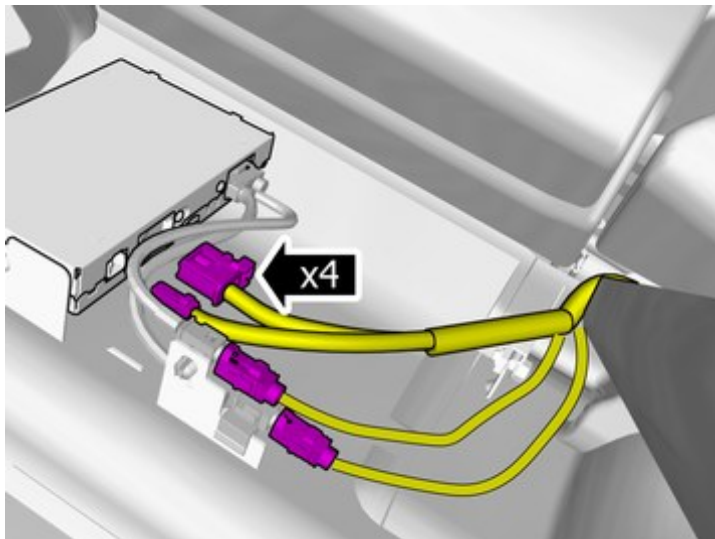

IMG-395171

Locate the pre-routed connectors.

Connect the connectors.

Installation

15



IMG-395755

Installation instructions, accessories

Volvo Car Corporation Gothenburg, Sweden

16

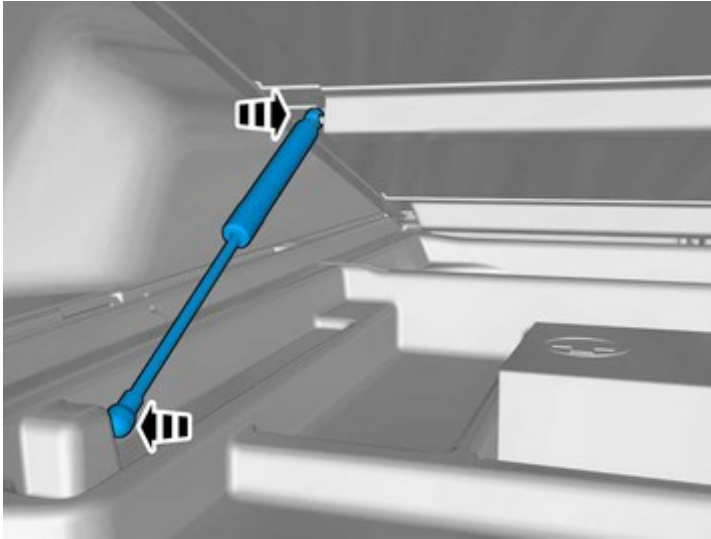

IMG-395756

17



IMG-395760

Installation instructions, accessories

Volvo Car Corporation Gothenburg, Sweden

18

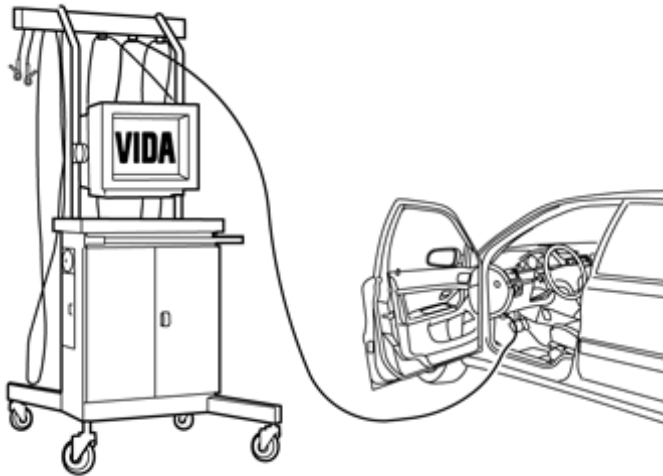

IMG-242268

Note!

First, download the software for preparatory installation according to the accessory catalogue. Then do the download/reload of software for the accessory function.

Note!

When doing an aftermarket installation of DAB or DAB+, it is necessary to carry out a DAB application download.

Note!

When upgrading from DAB to DAB+, a DAB re-load is necessary.

Carry out a download, or a re-load, of accessory function software by following VIDA service information.