



Installation instructions, accessories

Volvo Car Corporation Gothenburg, Sweden

Istruzioni No
31346083

Versione
1.0

Part. No.
31407107, 31350479, 31346554

Gancio di traino, centralina (TRM)



Installation instructions, accessories

Volvo Car Corporation Gothenburg, Sweden

Attrezzatura

VIDA

IMG-242205

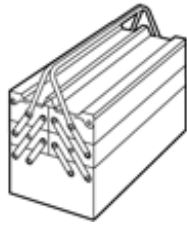

IMG-345497



IMG-332314

MIN.



IMG-239664

Nm
lbf.ft

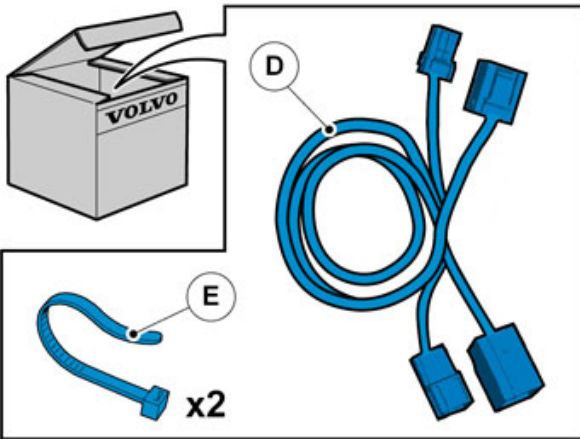
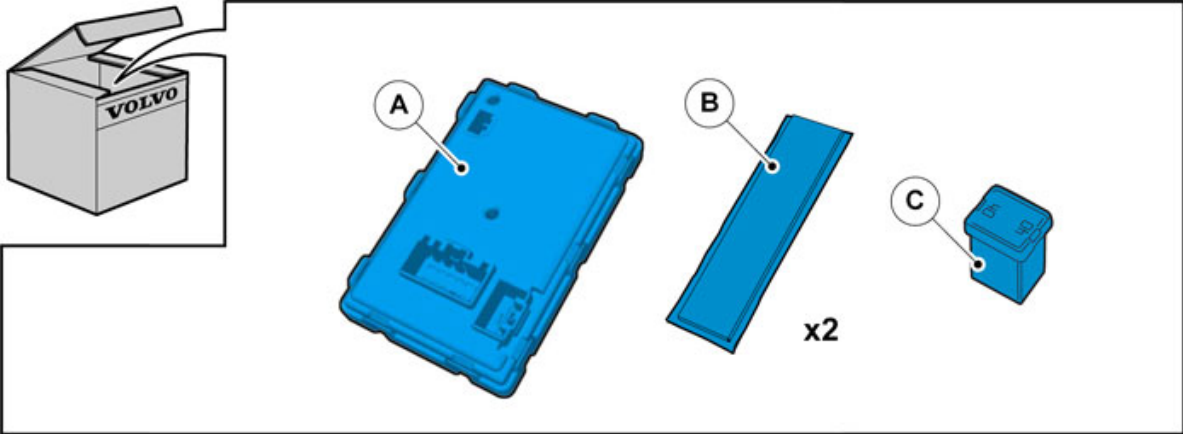

IMG-360181



INTRODUZIONE

Leggere attentamente tutte le istruzioni prima di iniziare l'installazione.

Le note e i testi di avvertenza sono forniti per la vostra sicurezza e per ridurre al minimo il rischio di rotture in occasione dell'installazione.

Verificare che tutti gli attrezzi specificati nelle istruzioni siano presenti prima di iniziare l'installazione.

Alcune fasi nelle istruzioni sono spiegate solo con le illustrazioni. Per i passaggi più complicati è usato anche un testo esplicativo.

In caso di problemi con le istruzioni o l'accessorio, mettersi in contatto con il concessionario Volvo locale.

1

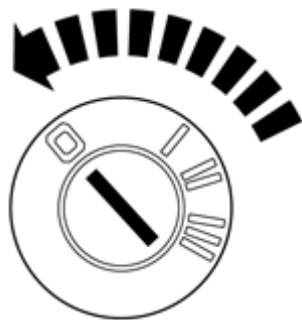

Portare la chiave di accensione in posizione 0.

Nota!

Attendere almeno un minuto prima di scollegare i connettori o rimuovere altre apparecchiature elettriche.

IMG-245980

Vale per il modello S60



Installation instructions, accessories

Volvo Car Corporation Gothenburg, Sweden

2

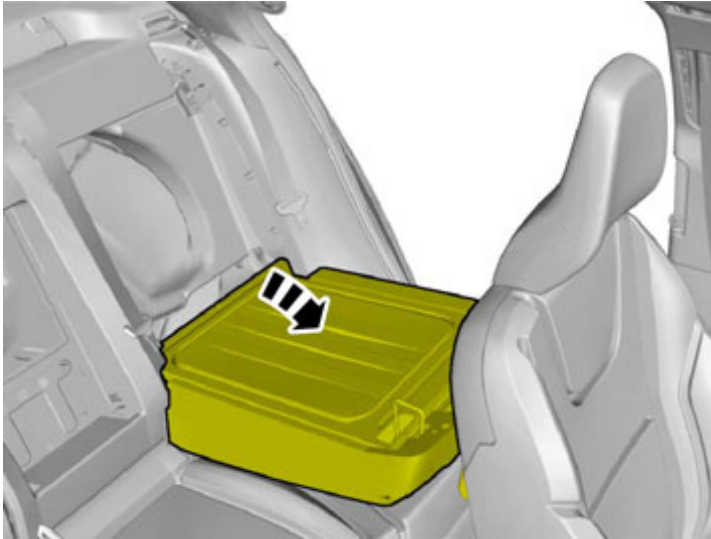

IMG-339894

Vale per il modello S60

3

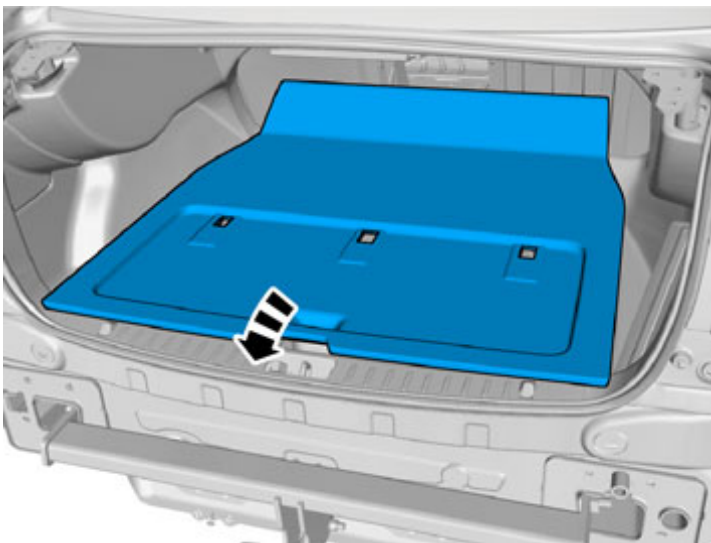

IMG-340180



Installation instructions, accessories

Volvo Car Corporation Gothenburg, Sweden

4

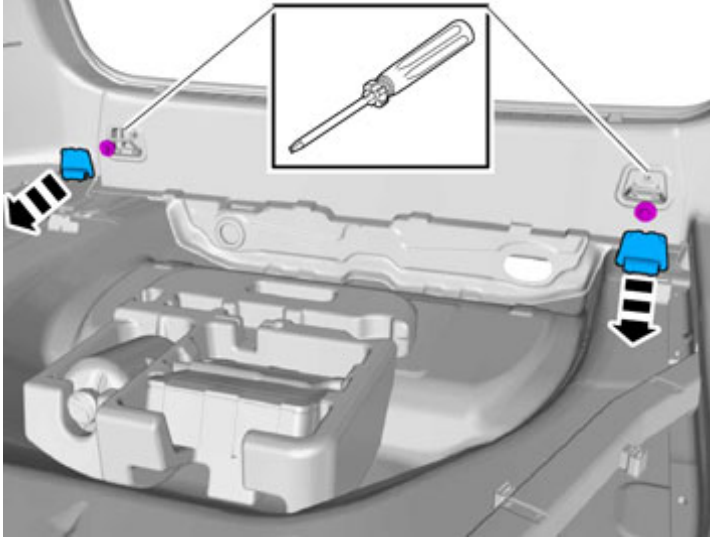

IMG-340028

Staccare cautamente a leva i coperchi e rimuovere le viti.

5

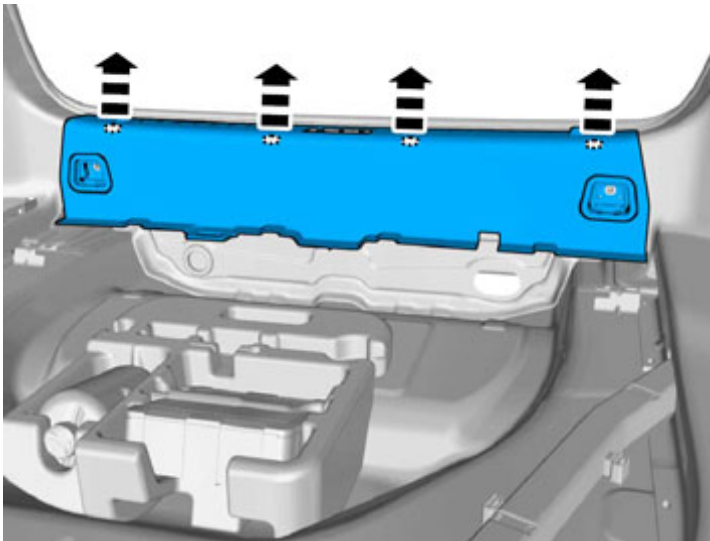

IMG-339896

Rimuovere il pannello.



Installation instructions, accessories

Volvo Car Corporation Gothenburg, Sweden

6

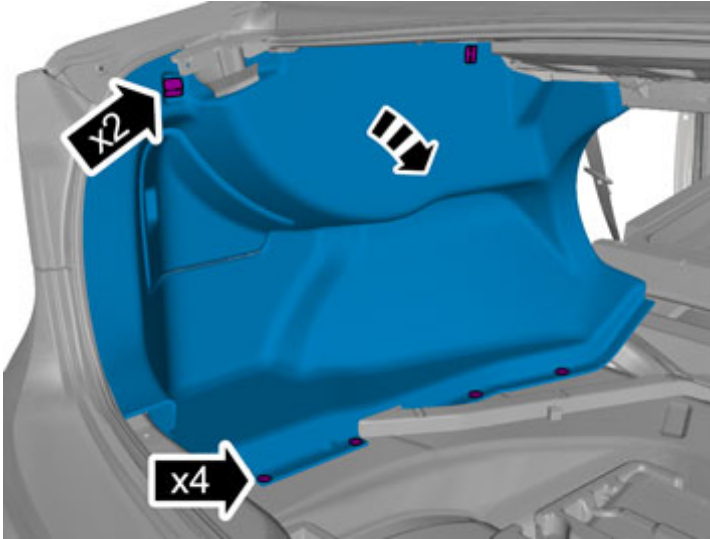

IMG-340029

7

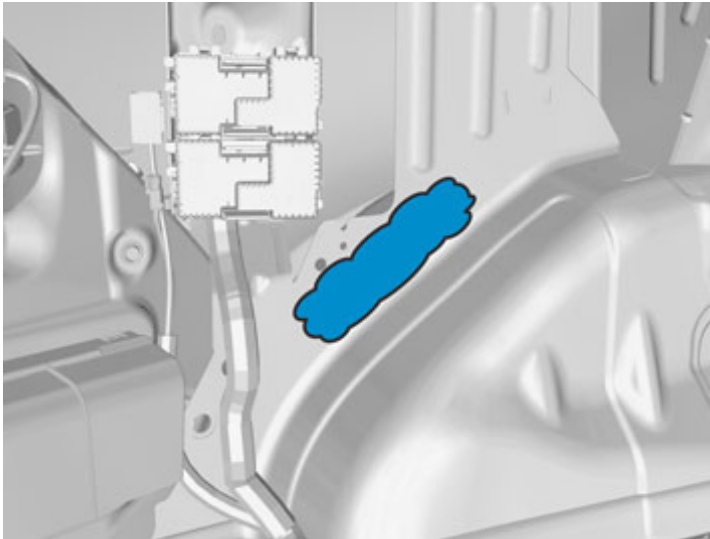

IMG-361427

Usare: Isopropanol, codice articolo 1161721

Strofinare e asciugare.



Installation instructions, accessories

Volvo Car Corporation Gothenburg, Sweden

8

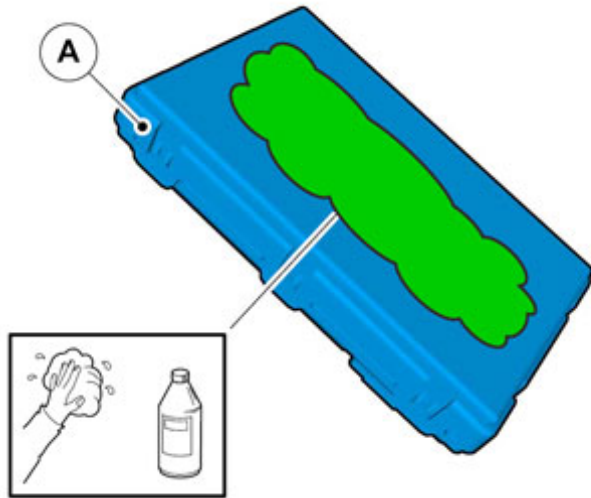

IMG-360218

Usare: Isopropanol, codice articolo 1161721

Strofinare e asciugare.

9

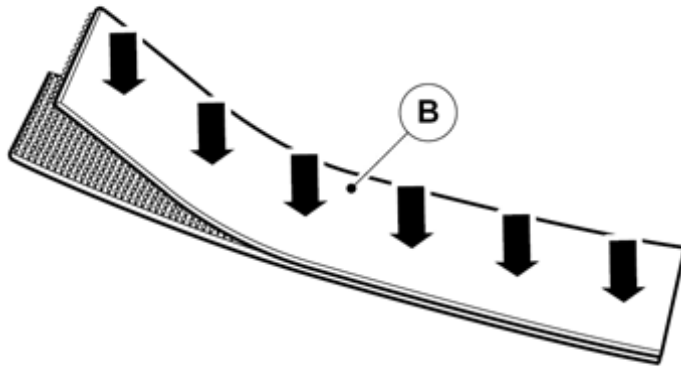

IMG-356181

Prendere i due nastri al velcro dal kit e comprimerli insieme bordo a bordo.



Installation instructions, accessories

Volvo Car Corporation Gothenburg, Sweden

10

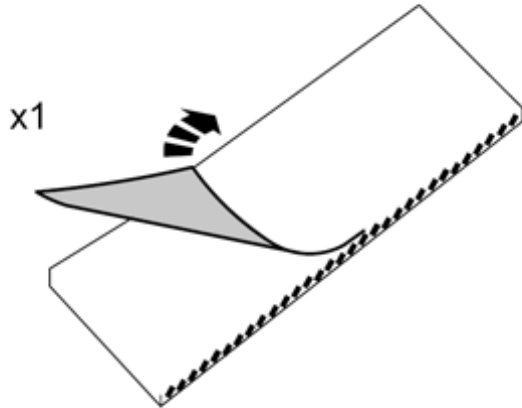

Rimuovere il nastro adesivo di protezione da uno dei lato dei nastri al velcro.

IMG-360227

11

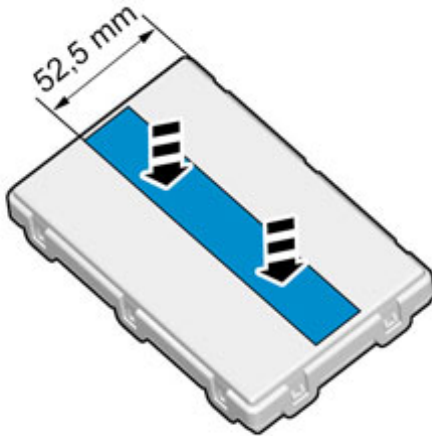

Per l'installazione del nastro Velcro, la base di installazione deve mantenere una temperatura costante di almeno +20° C (68°F).

IMG-360231



Installation instructions, accessories

Volvo Car Corporation Gothenburg, Sweden

12

Rimuovere il nastro adesivo protettivo.

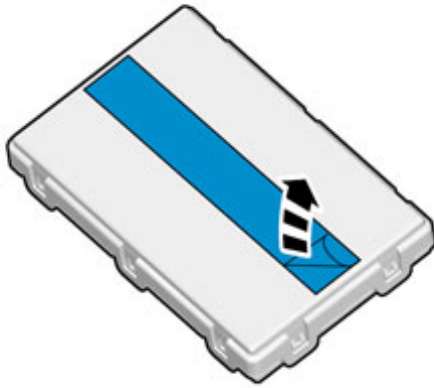

IMG-360236

13



Per l'installazione del nastro Velcro, la base di installazione deve mantenere una temperatura costante di almeno +20° C (68°F).

Fissare correttamente a pressione la centralina.

IMG-361429



Installation instructions, accessories

Volvo Car Corporation Gothenburg, Sweden

14

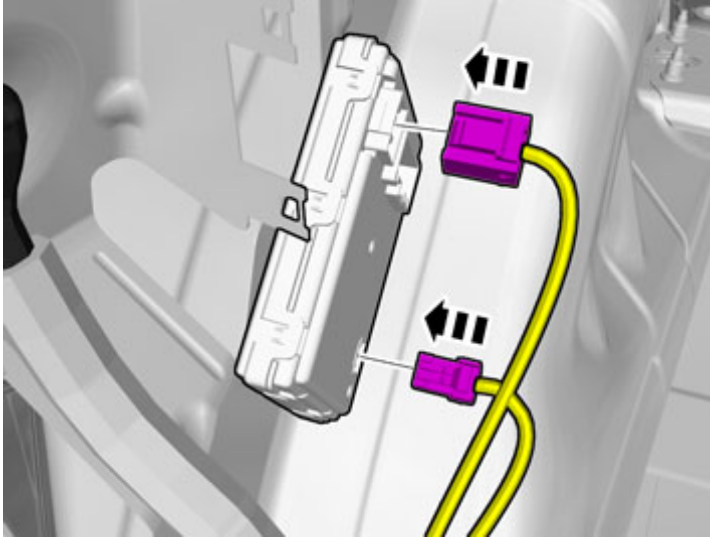

IMG-361430

Collegare i connettori predisposti alla centralina.
Presenti vicino alla basetta portafusibili posteriore.

15

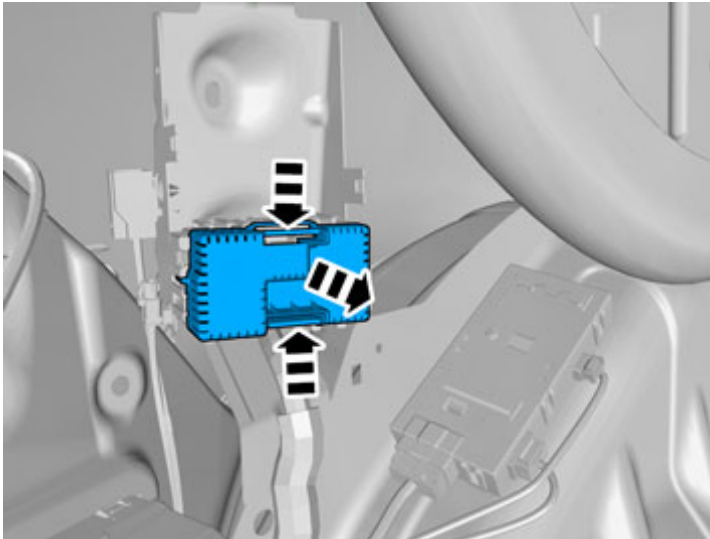

IMG-340109

Rimuovere il coperchio.



Installation instructions, accessories

Volvo Car Corporation Gothenburg, Sweden

16

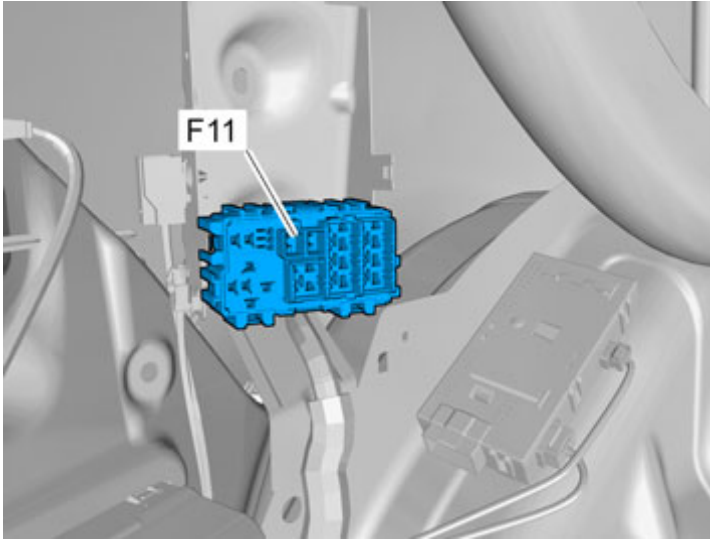

IMG-340105

Montare un fusibile da 40 A in posizione F11.

17

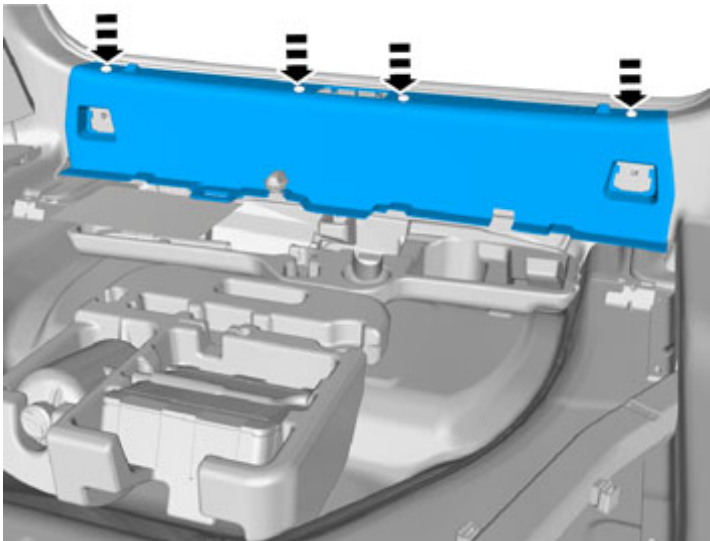

IMG-340201



Installation instructions, accessories

Volvo Car Corporation Gothenburg, Sweden

18

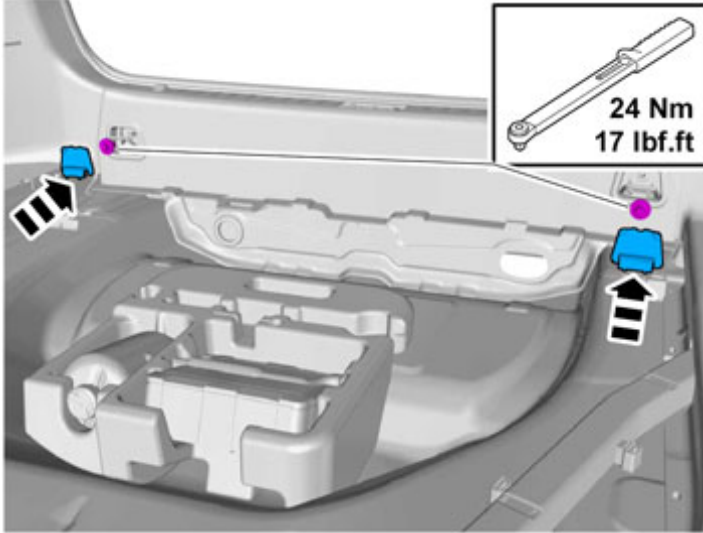

IMG-339899

19

Rimettere a posto i dettagli staccati in ordine inverso.

20

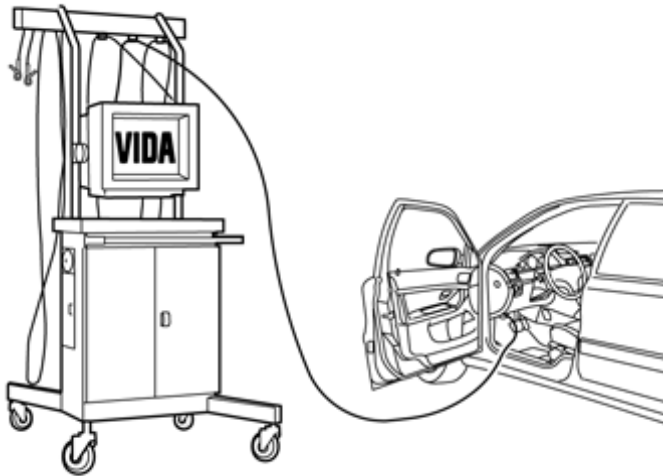

IMG-242268

Scaricare il software per il funzionamento dell'accessorio seguendo le indicazioni per l'assistenza in VIDA.

Vedere VIDA o il catalogo dei ricambi per il codice componente del software.



Installation instructions, accessories

Volvo Car Corporation Gothenburg, Sweden

21

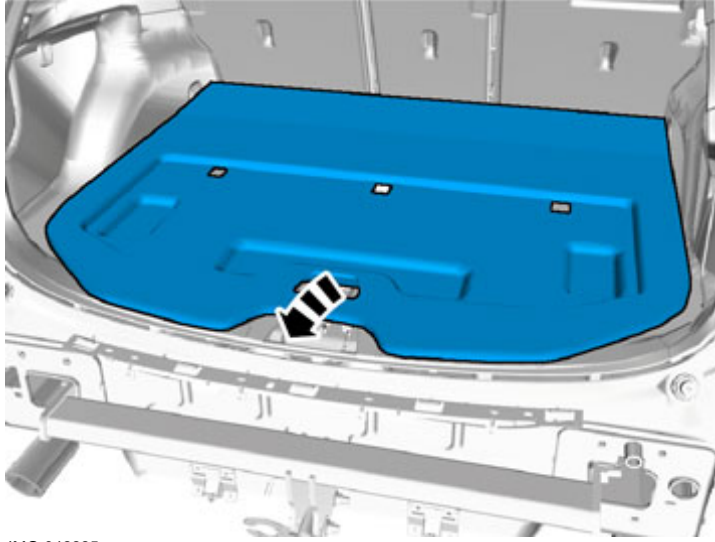

IMG-342225

Vale per il modello V60

22

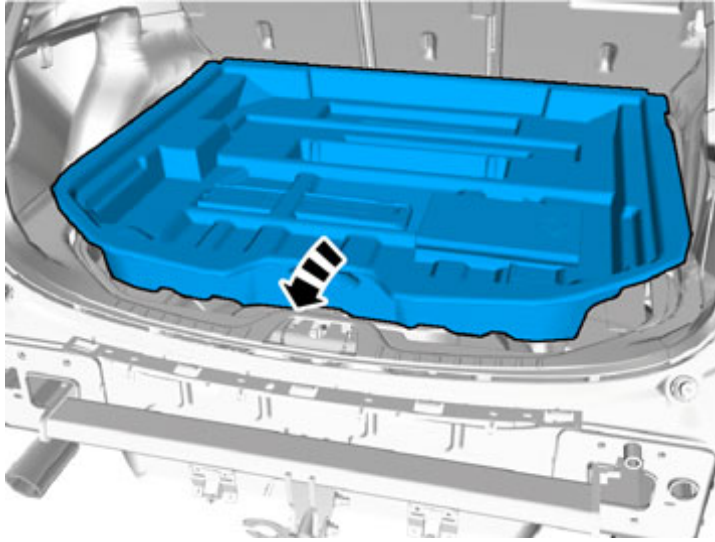

IMG-342227



Installation instructions, accessories

Volvo Car Corporation Gothenburg, Sweden

23

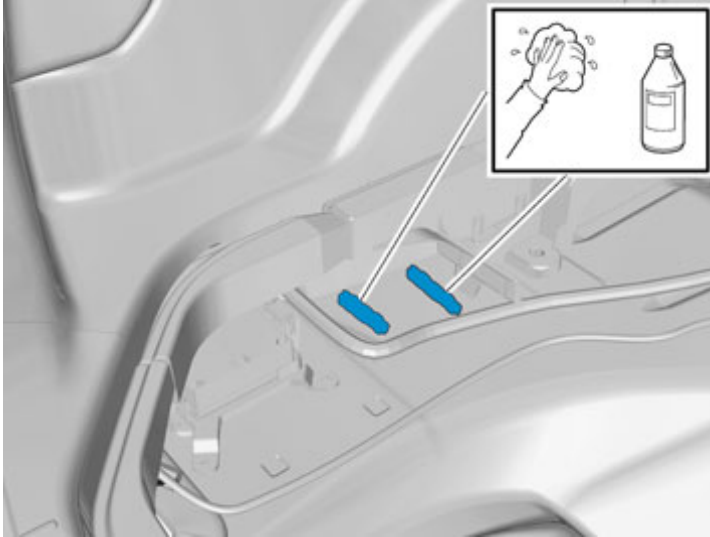

IMG-361456

Usare: Isopropanol, codice articolo 1161721

Strofinare e asciugare.

24

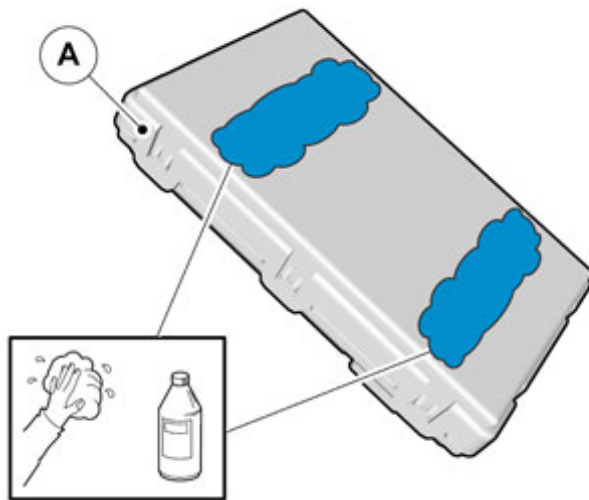

IMG-356179

Usare: Isopropanol, codice articolo 1161721

Strofinare e asciugare.



Installation instructions, accessories

Volvo Car Corporation Gothenburg, Sweden

25

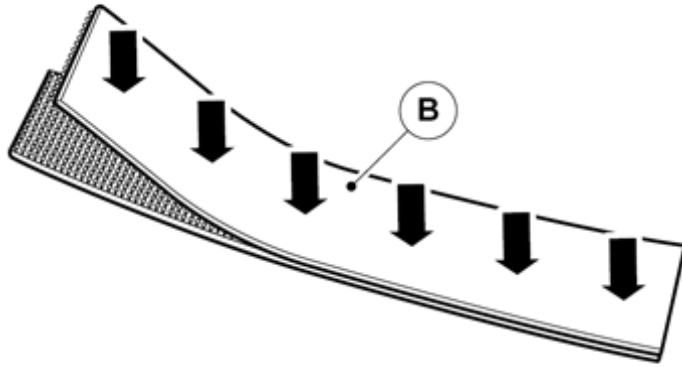

IMG-356181

26

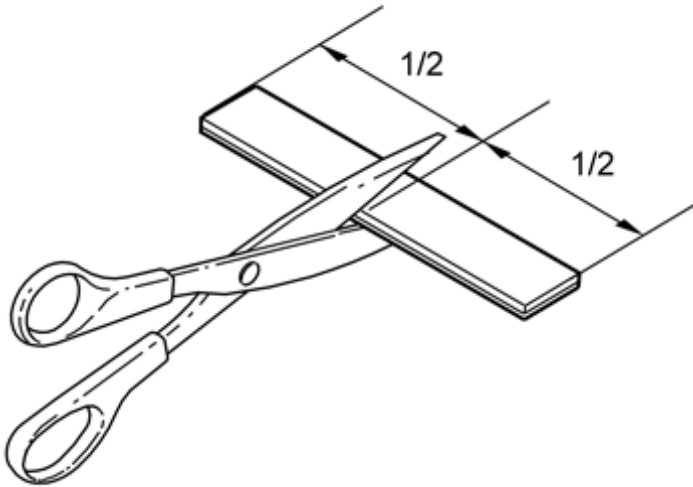

IMG-222282

27

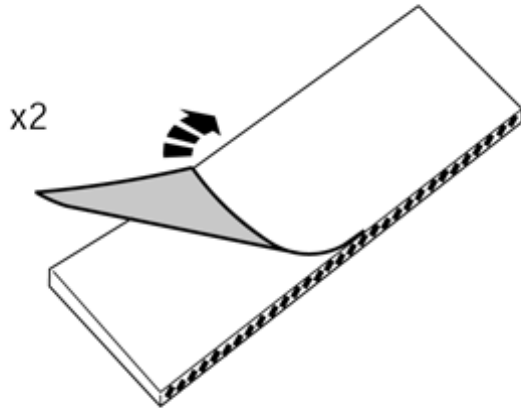

IMG-241925

28

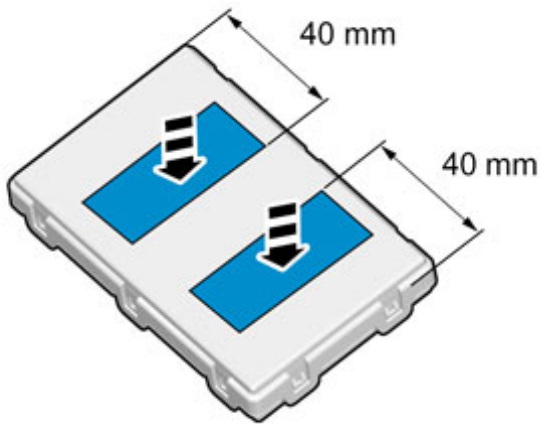

Per l'installazione del nastro Velcro, la base di installazione deve mantenere una temperatura costante di almeno +20° C (68°F).

IMG-356351



29

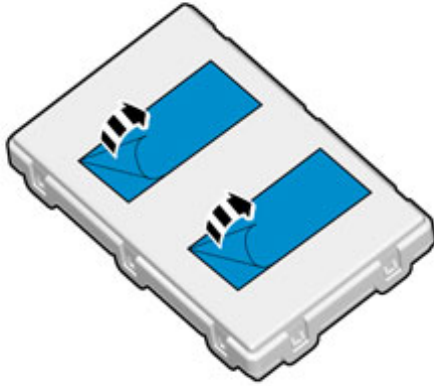

IMG-356352

30

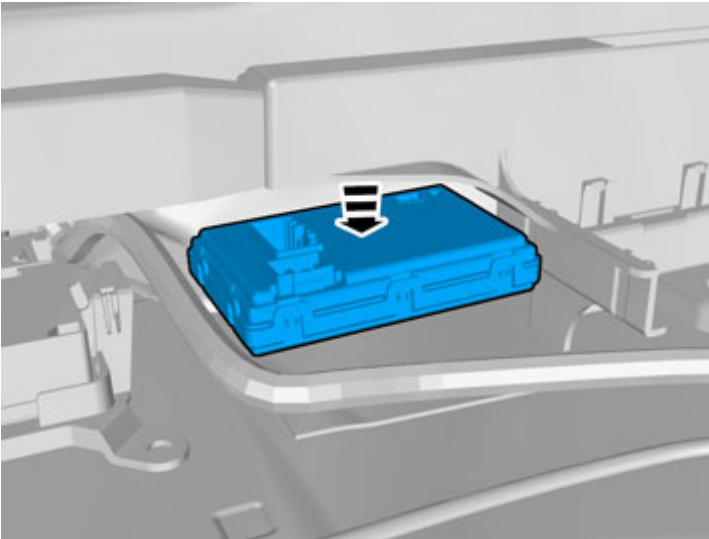

IMG-361461

Per l'installazione del nastro Velcro, la base di installazione deve mantenere una temperatura costante di almeno +20° C (68°F).

Fissare a pressione la centralina sul pianale del vano bagagliaio sulla superficie ripulita.



Installation instructions, accessories

Volvo Car Corporation Gothenburg, Sweden

31

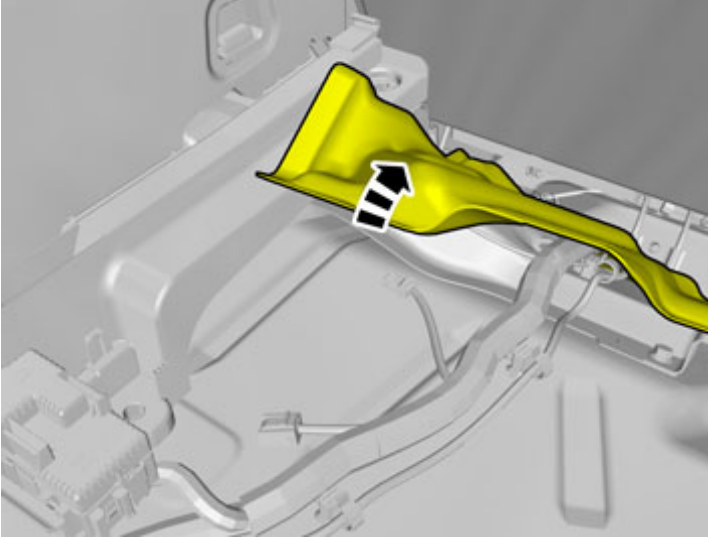

IMG-342289

Vale per i veicoli con anno di modello fino al -2012

Sollevare il tappetino isolante sul bordo anteriore, lato sinistro del bagagliaio.

32

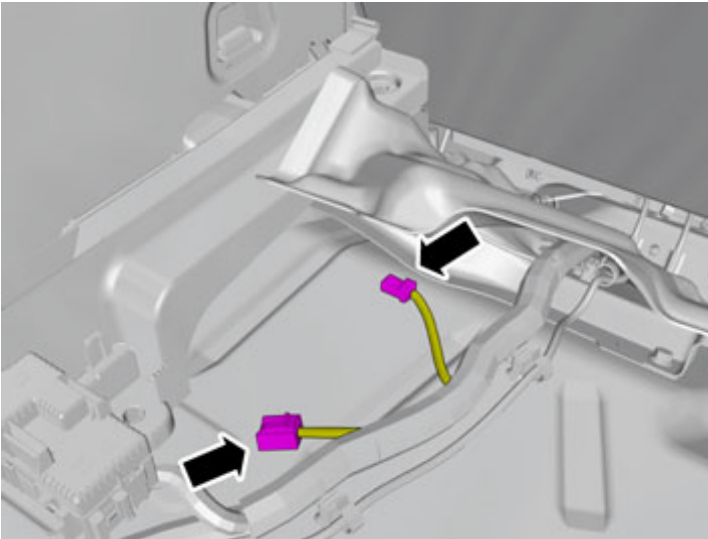

IMG-361448

Localizzare i connettori nel cablaggio dell'auto.

33

Collegare il cablaggio di prolunga ai connettori localizzati.

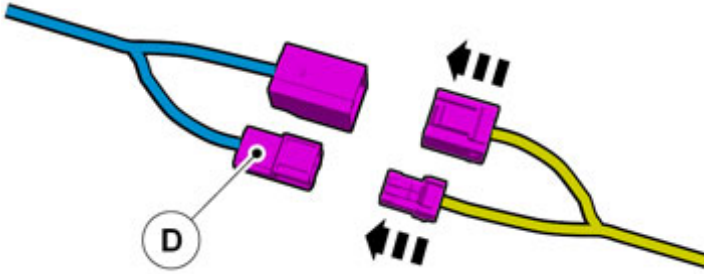

IMG-360183

34

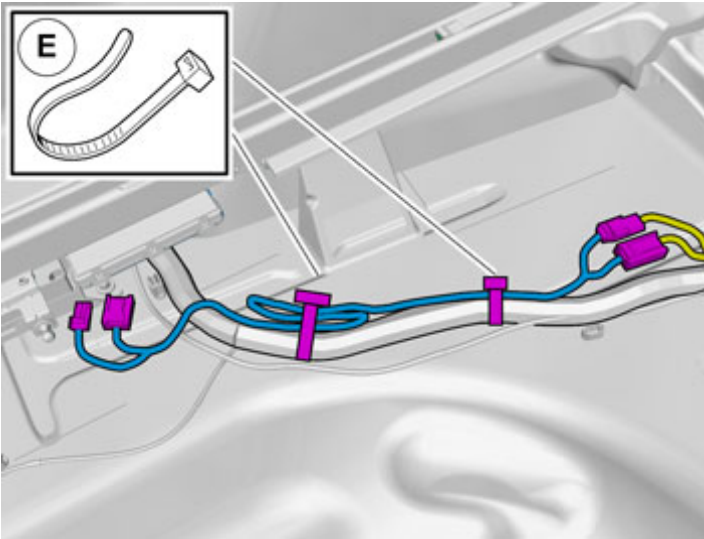

IMG-360336

Far scorrere il cablaggio di prolunga lungo il cablaggio esistente.
Usare fascette serrafili per fissare l'eventuale lunghezza eccedente.



Installation instructions, accessories

Volvo Car Corporation Gothenburg, Sweden

35

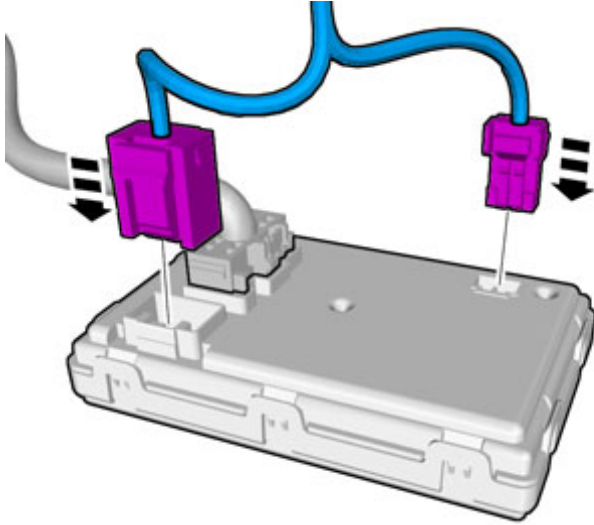

Collegare i connettori dal cablaggio di prolunga alla centralina.

IMG-361449

36

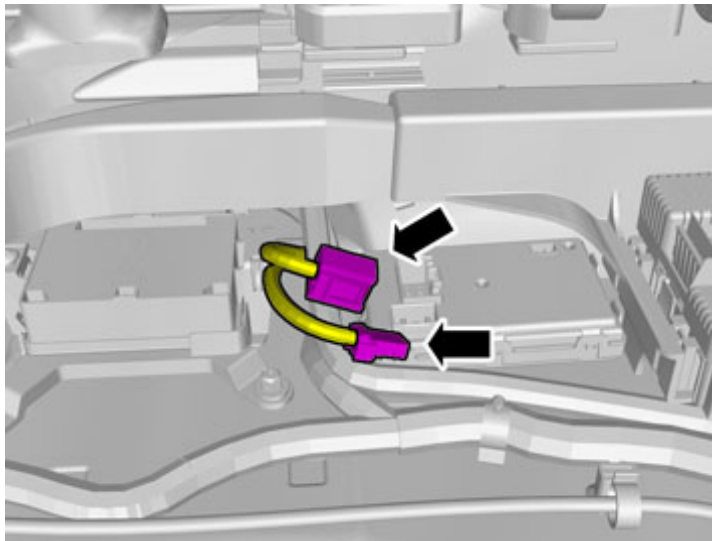

Vale per i veicoli con anno di modello a partire dal 2013-

Localizzare i connettori nel cablaggio dell'auto.

IMG-361481



Installation instructions, accessories

Volvo Car Corporation Gothenburg, Sweden

37

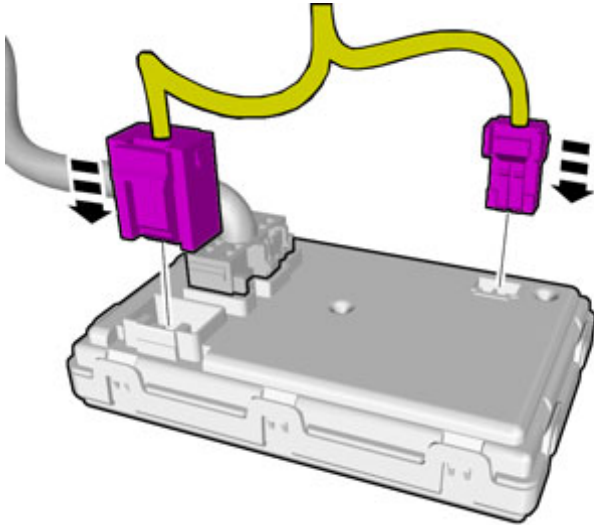

Collegare i connettori alla centralina.

IMG-361483

38

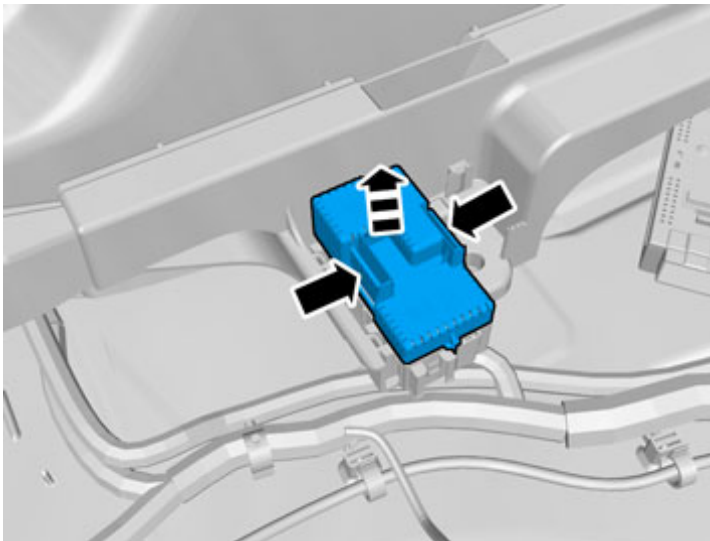

Vale per tutte le vetture

Rimuovere il coperchio nero sul portafusibili

IMG-342291



Installation instructions, accessories

Volvo Car Corporation Gothenburg, Sweden

39

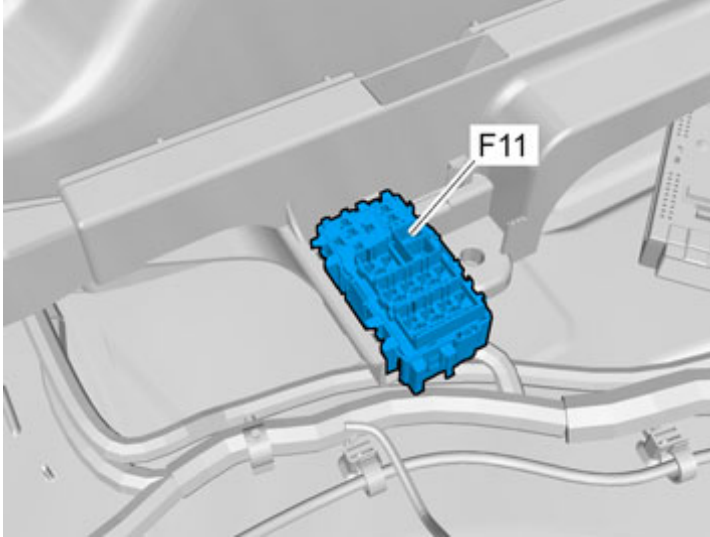

IMG-342292

Montare un fusibile da 40 A in posizione F11.

40

Rimettere a posto i dettagli staccati in ordine inverso.

41

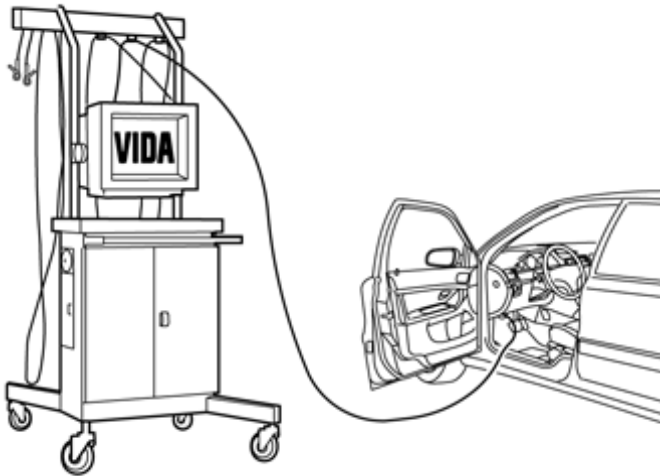

IMG-242268

Scaricare il software per il funzionamento dell'accessorio seguendo le indicazioni per l'assistenza in VIDA.

Vedere VIDA o il catalogo dei ricambi per il codice componente del software.