



Installation instructions, accessories

Volvo Car Corporation Gothenburg, Sweden

Instruction No	Version	Part. No.
31346083	1.0	31407107, 31350479, 31346554

Towbar, control module (TRM)



Installation instructions, accessories

Volvo Car Corporation Gothenburg, Sweden

Equipment

VIDA

IMG-242205

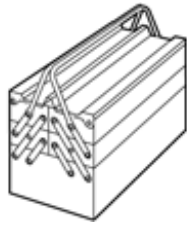

IMG-345497



IMG-332314



IMG-239664

Nm
lbf.ft

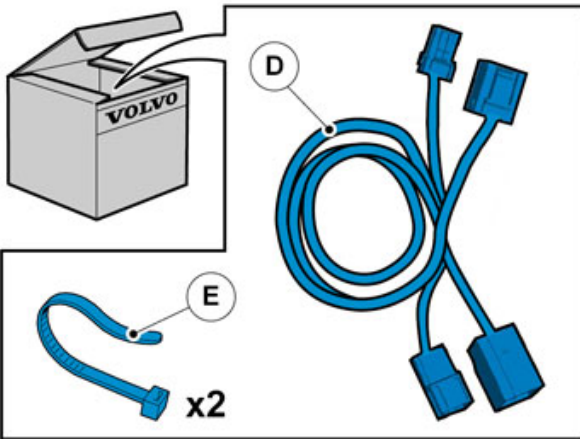
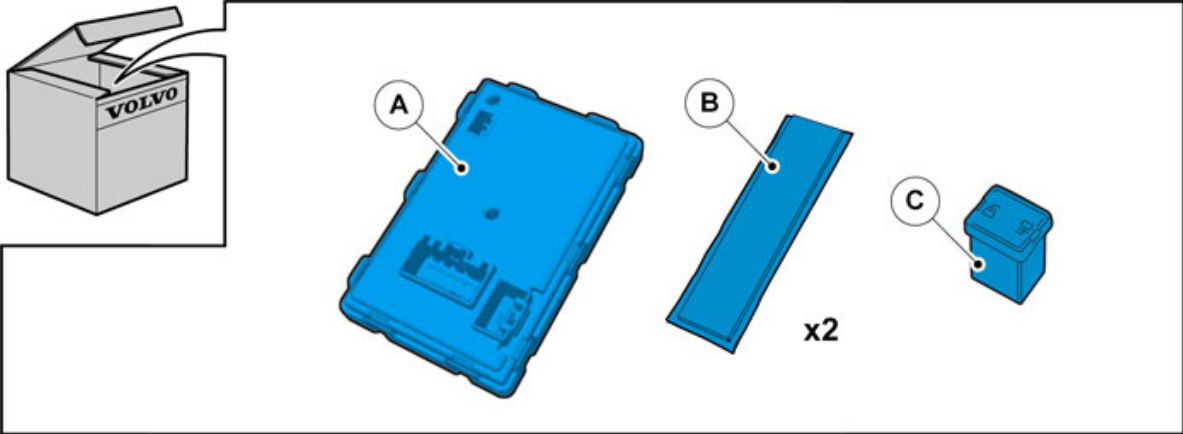

IMG-360181



Installation instructions, accessories

Volvo Car Corporation Gothenburg, Sweden

INTRODUCTION

Read through all of the instructions before starting installation.

Notifications and warning texts are for your safety and to minimise the risk of something breaking during installation.

Ensure that all tools stated in the instructions are available before starting installation.

Certain steps in the instructions are only presented in the form of images. Explanatory text is also given for more complicated steps.

In the event of any problems with the instructions or the accessory, contact your local Volvo dealer.

1



Set the ignition key to position 0.

Note!

Wait at least one minute before unplugging the connectors or removing other electrical equipment.

IMG-245980

Applies to the S60



Installation instructions, accessories

Volvo Car Corporation Gothenburg, Sweden

2

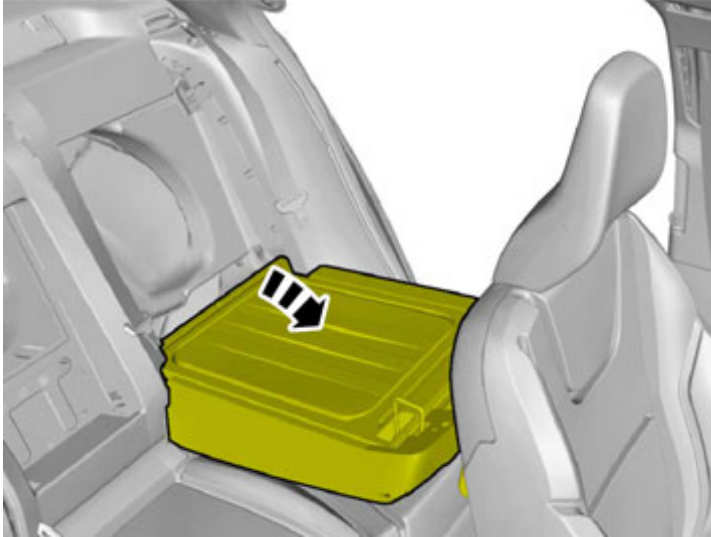

IMG-339894

Applies to the S60

3

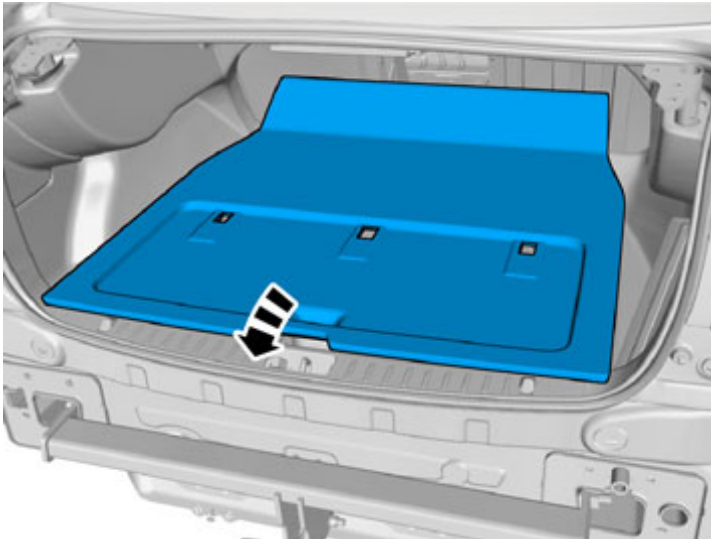

IMG-340180



Installation instructions, accessories

Volvo Car Corporation Gothenburg, Sweden

4

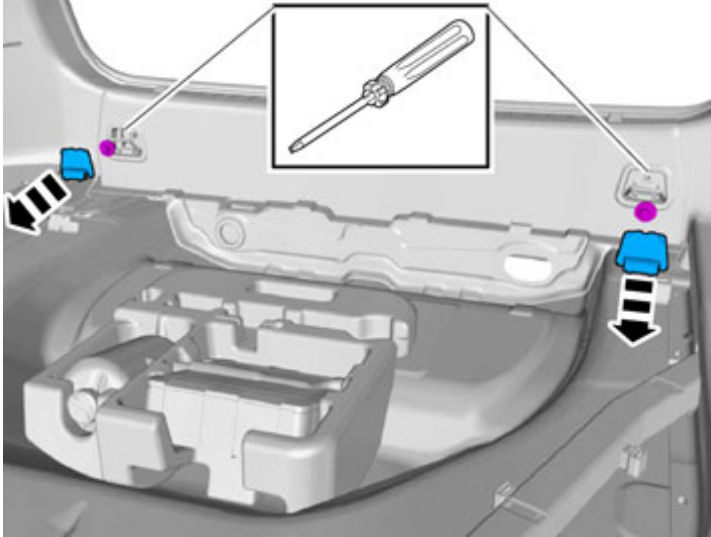

IMG-340028

Carefully pry off the covers and remove the screws.

5

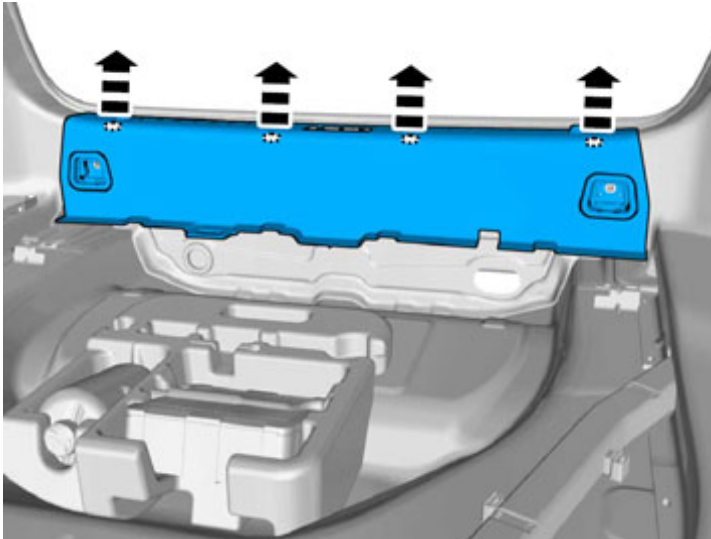

IMG-339896

Remove the panel.



Installation instructions, accessories

Volvo Car Corporation Gothenburg, Sweden

6

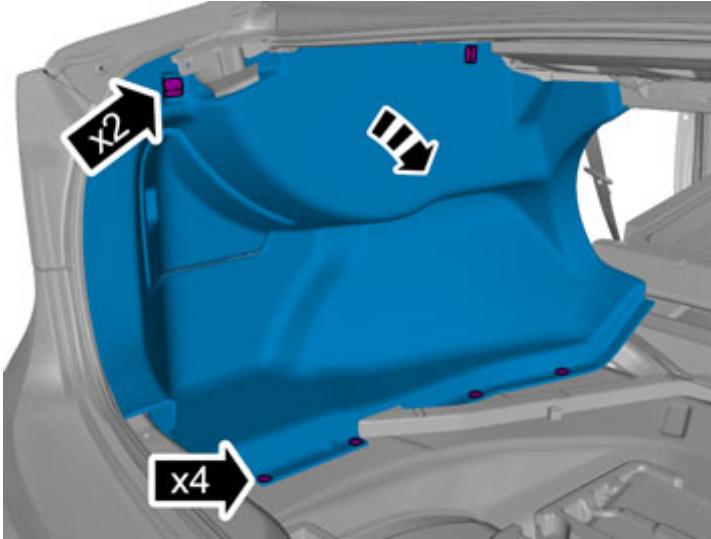

IMG-340029

7

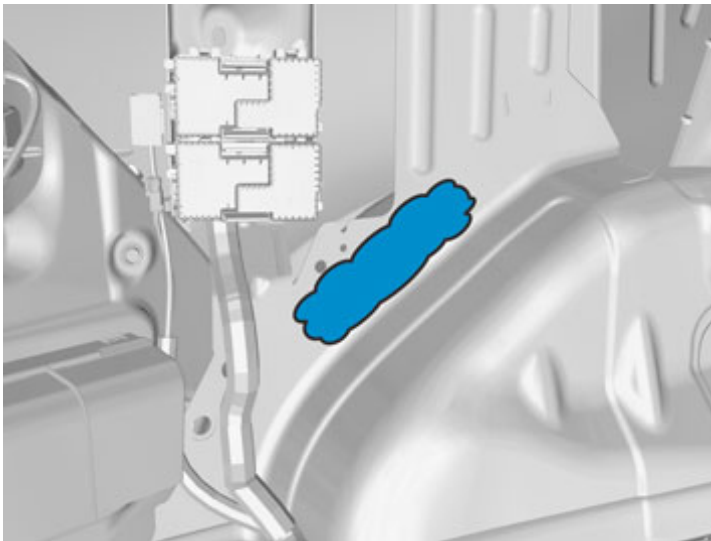

IMG-361427

Use: Isopropanol, P/N 1161721

Wipe dry.



Installation instructions, accessories

Volvo Car Corporation Gothenburg, Sweden

8

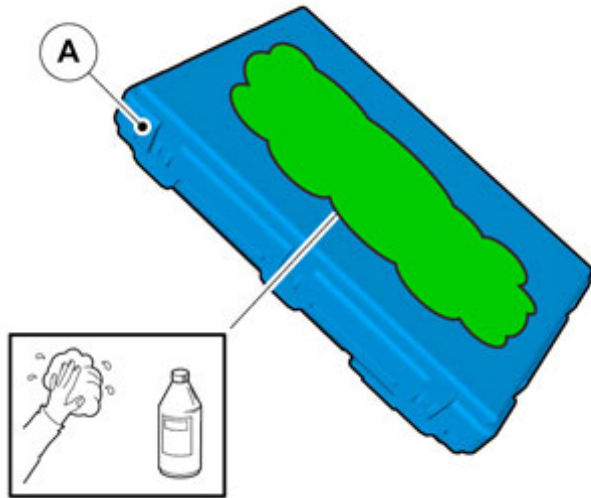

IMG-360218

Use: Isopropanol, P/N 1161721

Wipe dry.

9

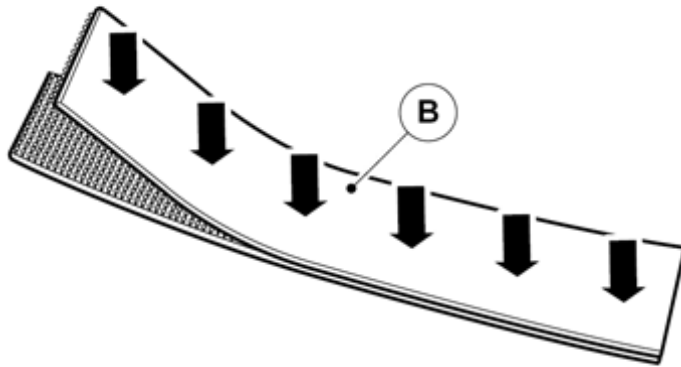

IMG-356181

Take the two Velcro straps from the kit and press them together edge to edge.



Installation instructions, accessories

Volvo Car Corporation Gothenburg, Sweden

10

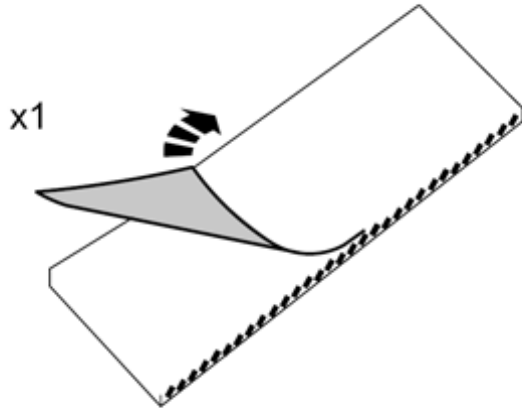

Remove the protective backing tape from one side of the Velcro straps.

IMG-360227

11

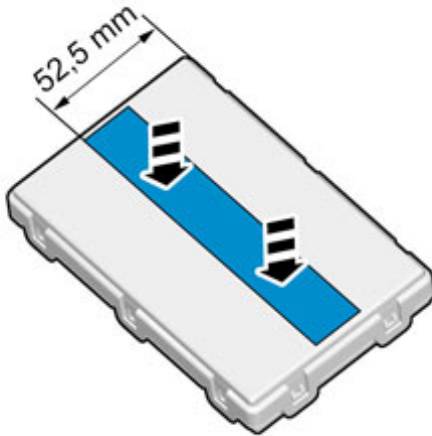

When installing Velcro tape the surface must maintain a temperature of at least +20 ° C (68°F).

IMG-360231



Installation instructions, accessories

Volvo Car Corporation Gothenburg, Sweden

12

Remove the masking tape.



IMG-360236

13



When installing Velcro tape the surface must maintain a temperature of at least +20 ° C (68°F).

Press the control module into place properly.

IMG-361429



Installation instructions, accessories

Volvo Car Corporation Gothenburg, Sweden

14

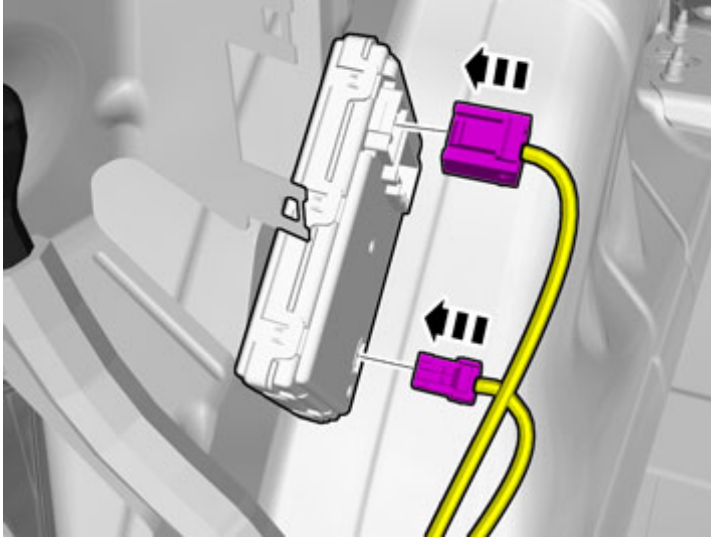

IMG-361430

Connect the pre-routed connectors to the control module.
Found in the connection to the rear fuse holder.

15

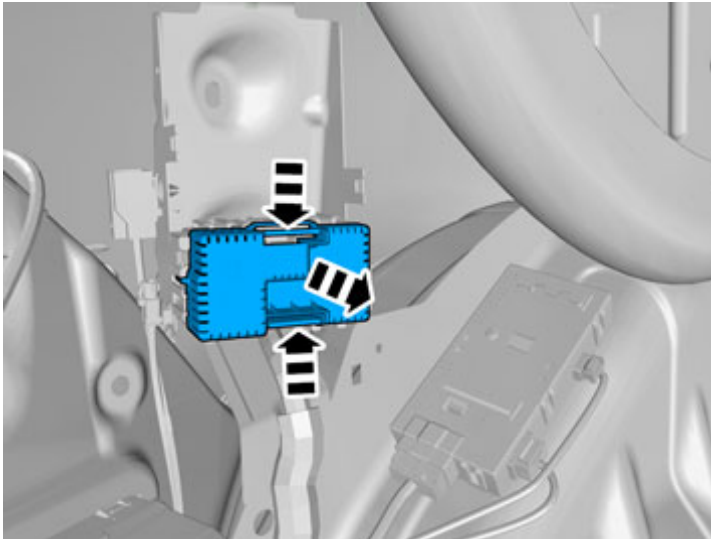

IMG-340109

Remove the cover.



Installation instructions, accessories

Volvo Car Corporation Gothenburg, Sweden

16

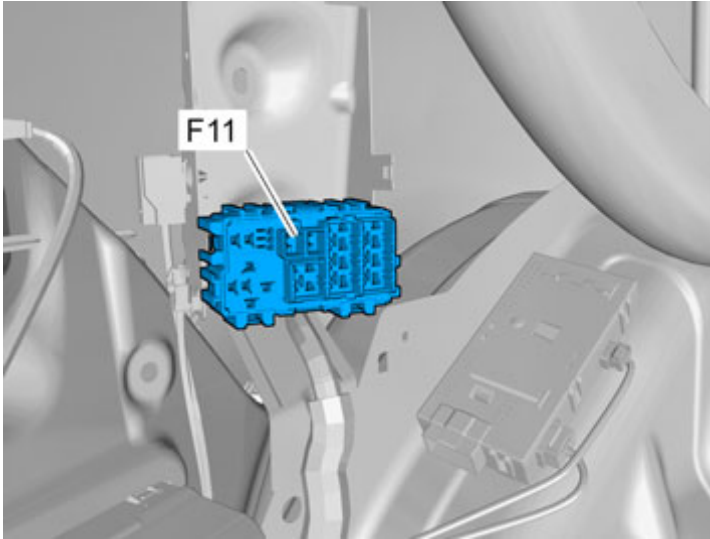

IMG-340105

Fit a 40 A fuse in position F11.

17

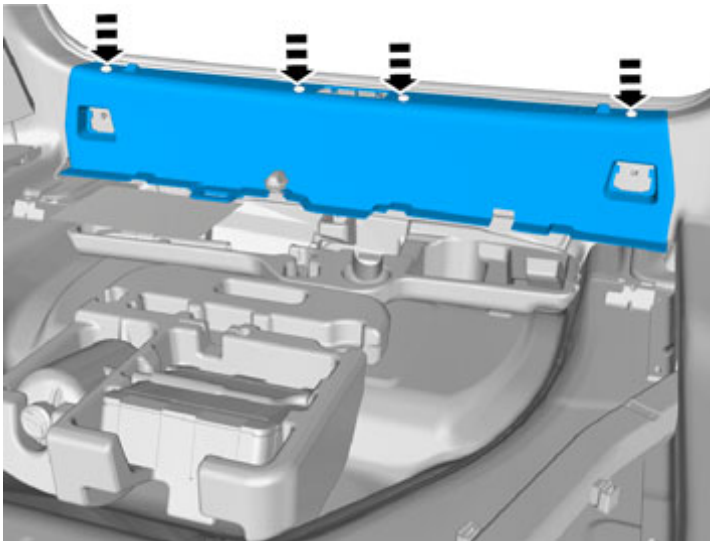

IMG-340201



Installation instructions, accessories

Volvo Car Corporation Gothenburg, Sweden

18

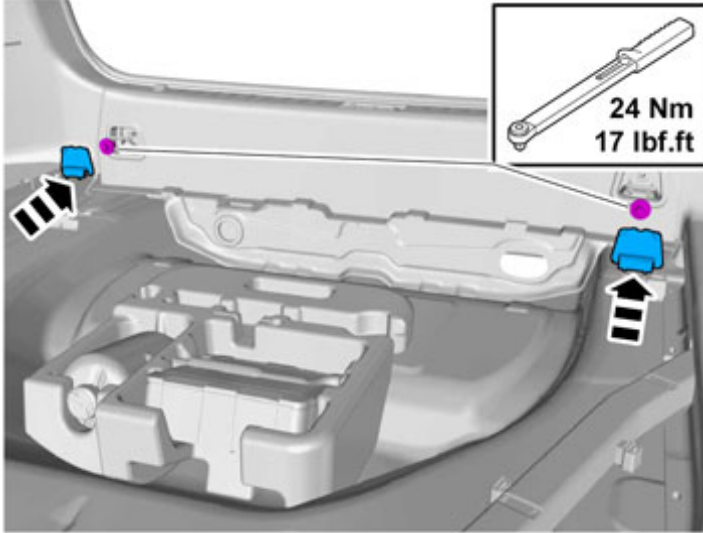

IMG-339899

19

Reinstall the detached components in reverse order.

20

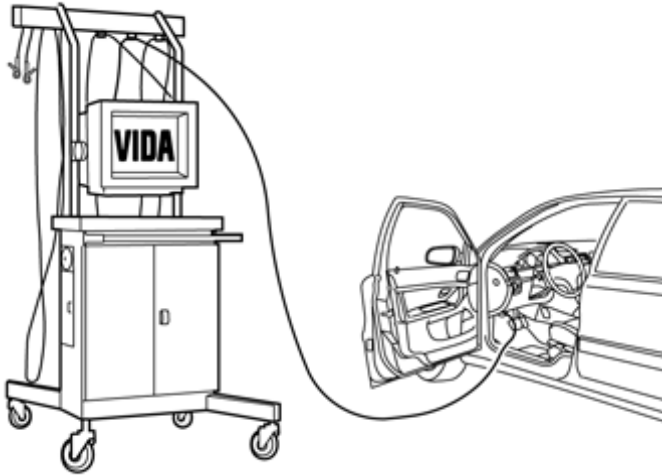

IMG-242268

Download the software for the accessory's function following the service information in VIDA.

See VIDA or the accessories catalogue for software part number.



Installation instructions, accessories

Volvo Car Corporation Gothenburg, Sweden

21

Applies to the V60

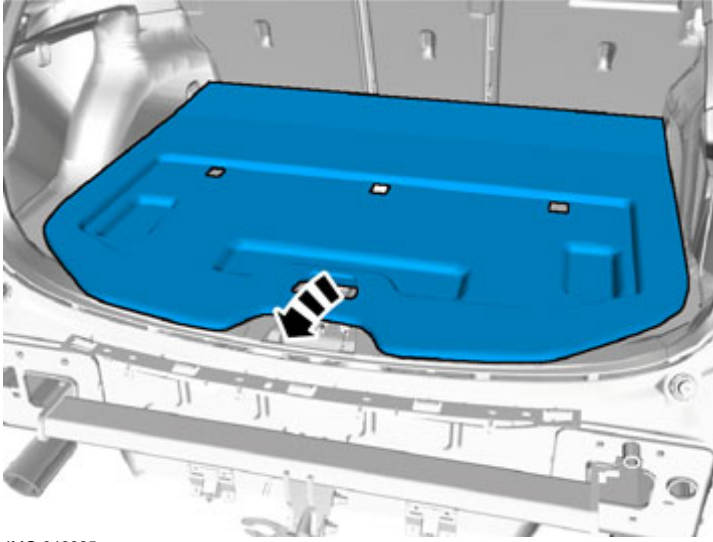

IMG-342225

22

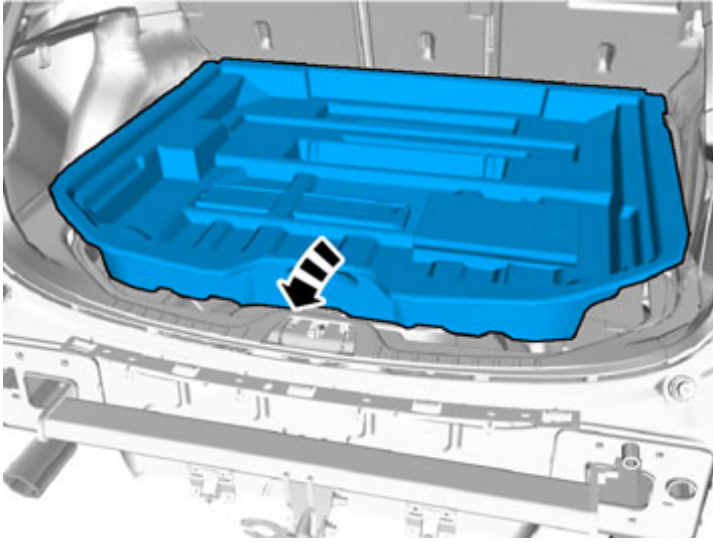

IMG-342227



Installation instructions, accessories

Volvo Car Corporation Gothenburg, Sweden

23

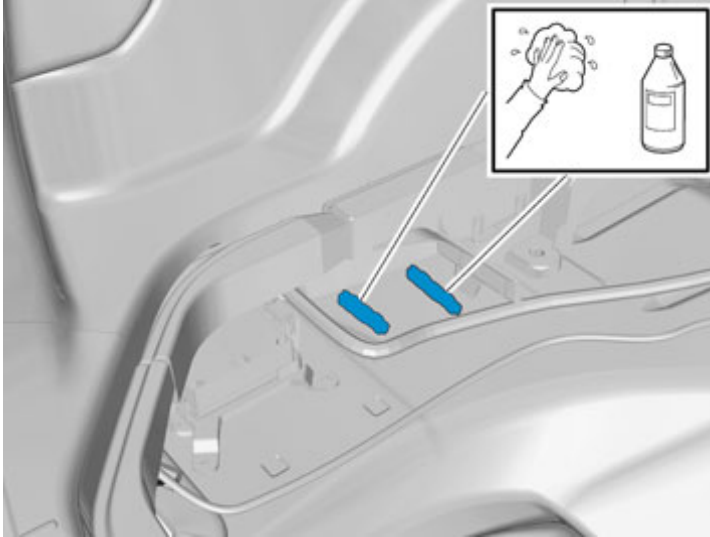

IMG-361456

Use: Isopropanol, P/N 1161721

Wipe dry.

24

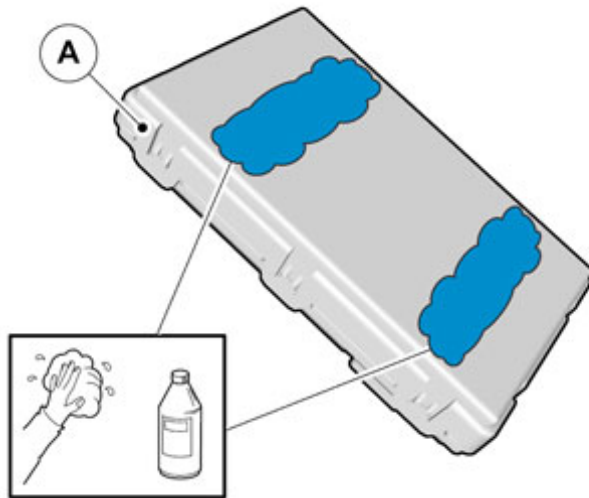

IMG-356179

Use: Isopropanol, P/N 1161721

Wipe dry.



Installation instructions, accessories

Volvo Car Corporation Gothenburg, Sweden

25

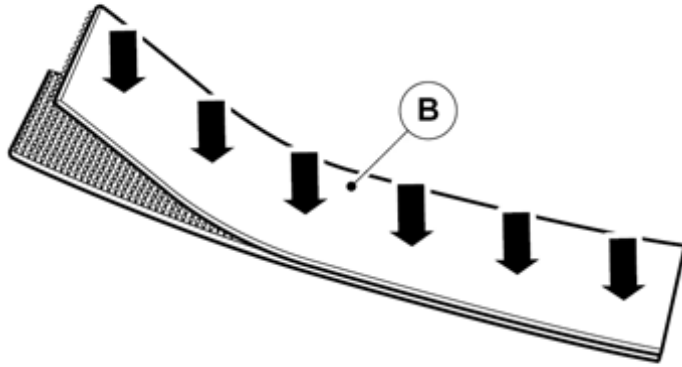

IMG-356181

26

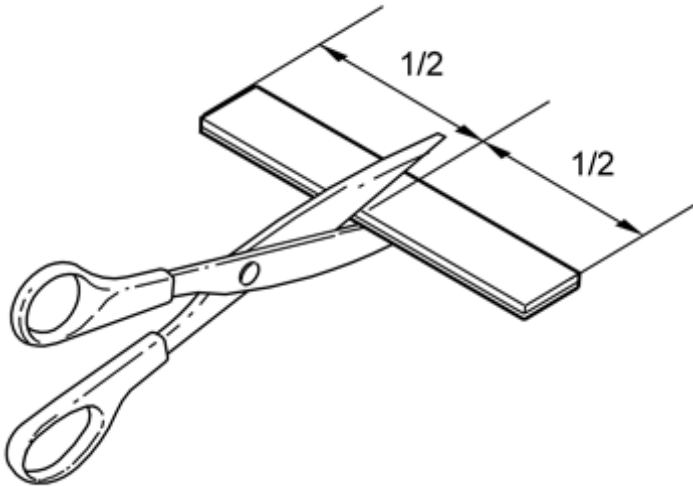

IMG-222282



Installation instructions, accessories

Volvo Car Corporation Gothenburg, Sweden

27

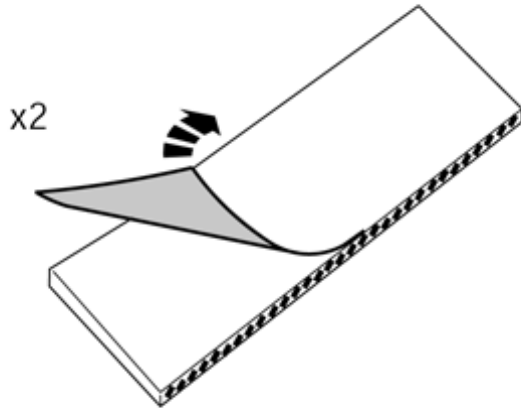

IMG-241925

28

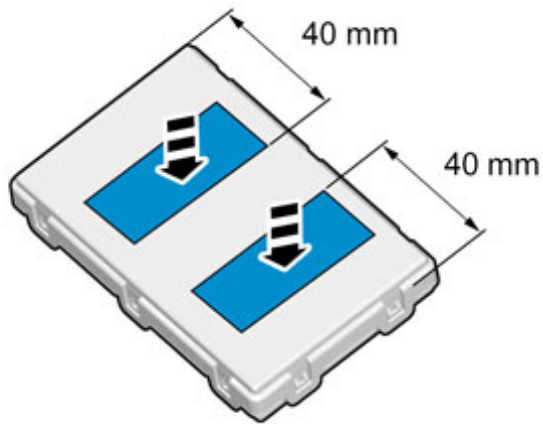

When installing Velcro tape the surface must maintain a temperature of at least +20 ° C (68°F).

IMG-356351



Installation instructions, accessories

Volvo Car Corporation Gothenburg, Sweden

29

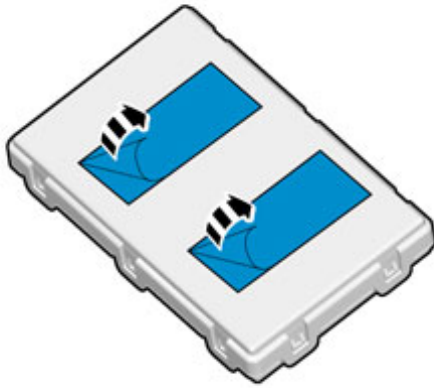

IMG-356352

30

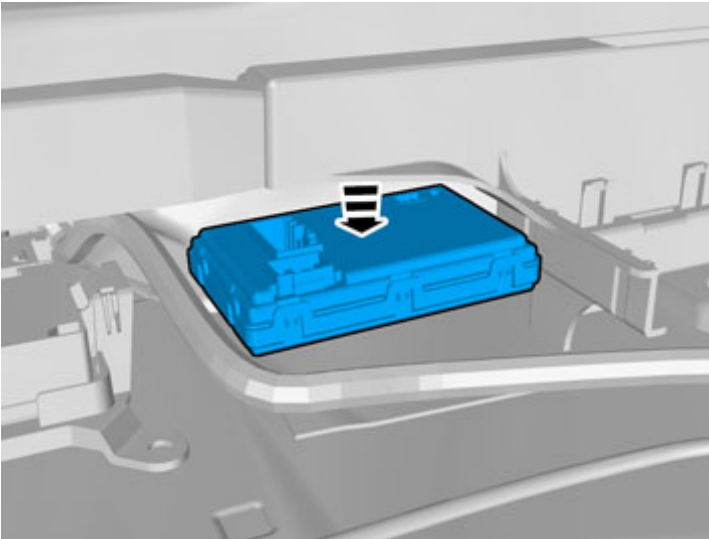

IMG-361461

When installing Velcro tape the surface must maintain a temperature of at least +20 ° C (68°F).

Press the control module onto the luggage compartment onto the cleaned surface.



Installation instructions, accessories

Volvo Car Corporation Gothenburg, Sweden

31

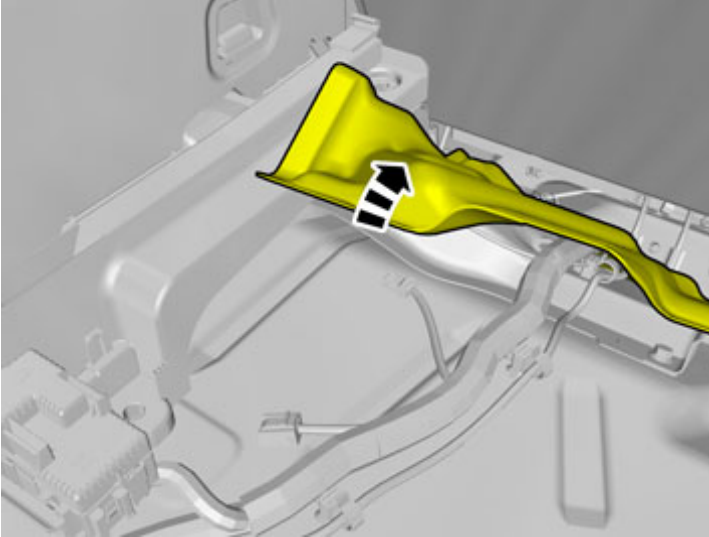

IMG-342289

Applies to cars with model year up to and including -2012

Fold up the insulation mat at the front edge on the left-hand side in the cargo compartment.

32

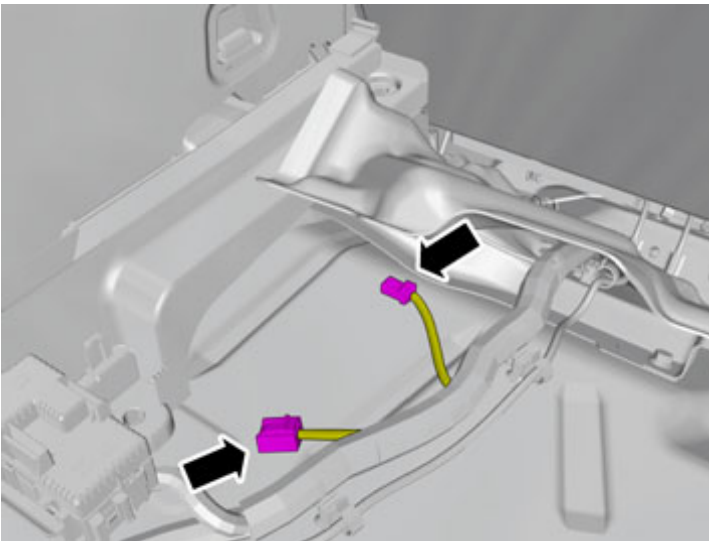

IMG-361448

Locate the connectors in the car's cable harness.



Installation instructions, accessories

Volvo Car Corporation Gothenburg, Sweden

33

Connect the extension cable to the located connector.

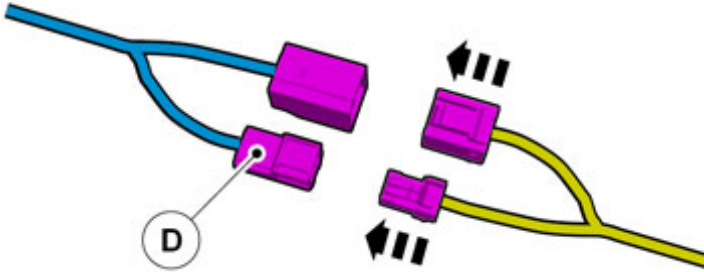

IMG-360183

34

Route the extension cable following the existing cable harness.
Use cable ties to secure any excess.

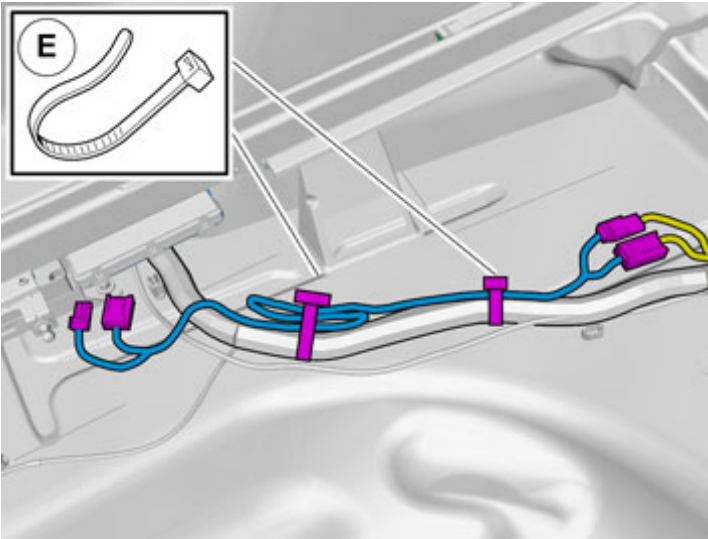

IMG-360336



Installation instructions, accessories

Volvo Car Corporation Gothenburg, Sweden

35

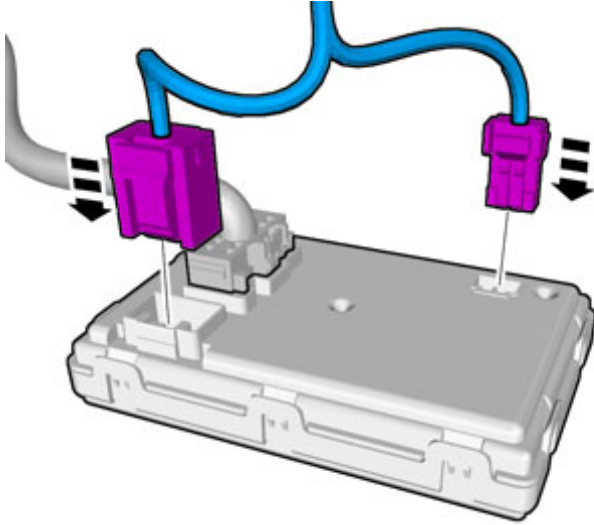

Connect the connectors from the extension wiring to the control module.

IMG-361449

36

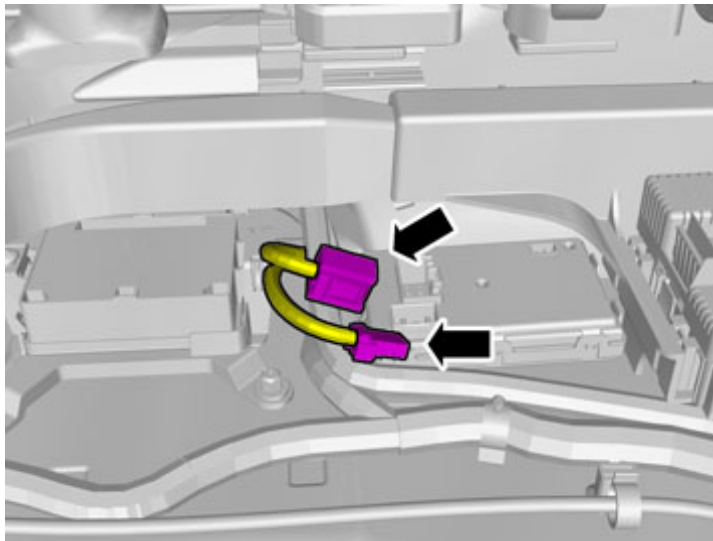

Applies to cars with model year from and including 2013-

Locate the connectors in the car's cable harness.

IMG-361481



Installation instructions, accessories

Volvo Car Corporation Gothenburg, Sweden

37

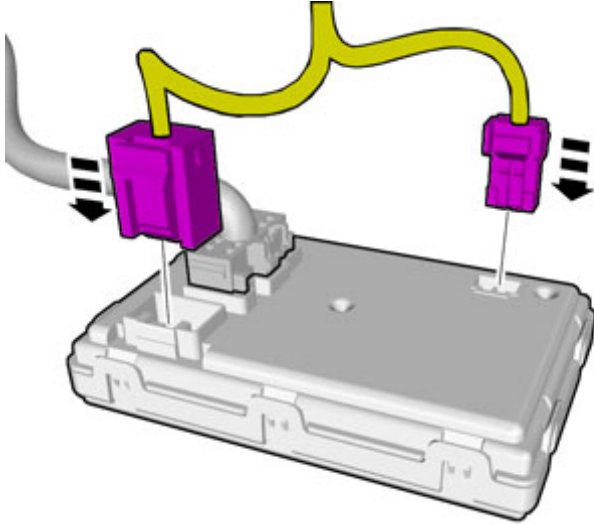

Connect the connectors to the control module.

IMG-361483

38

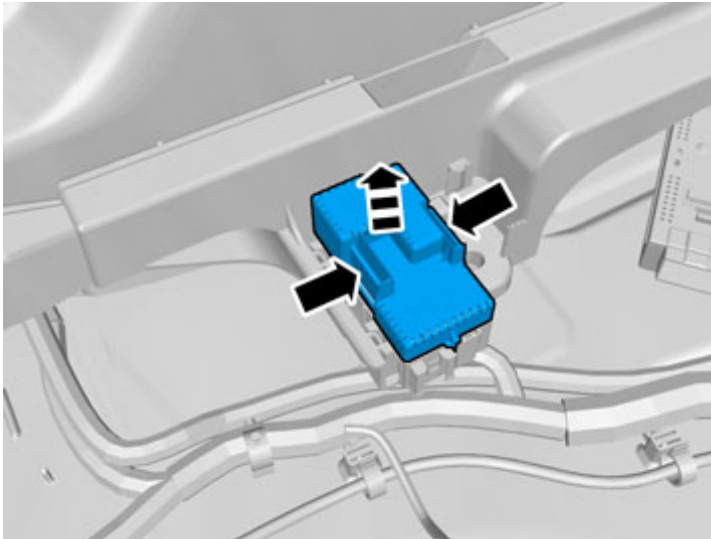

Applies to all models

Remove the black cover on the fuse holder

IMG-342291



Installation instructions, accessories

Volvo Car Corporation Gothenburg, Sweden

39

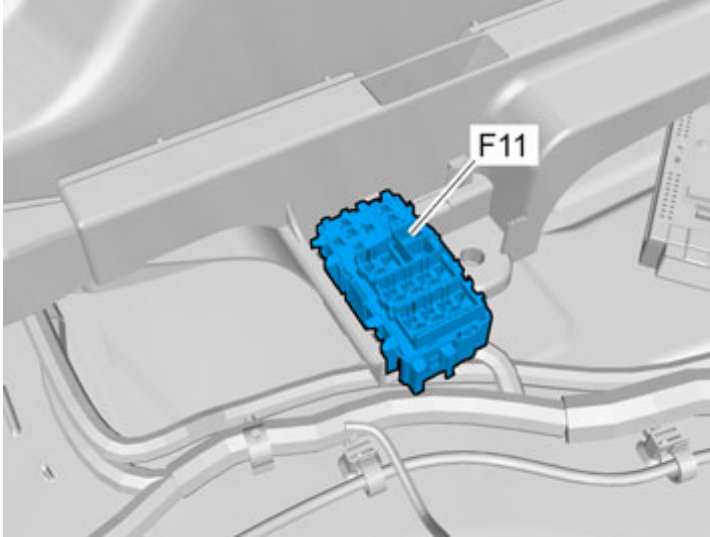

IMG-342292

Fit a 40 A fuse in position F11.

40

Reinstall the detached components in reverse order.

41

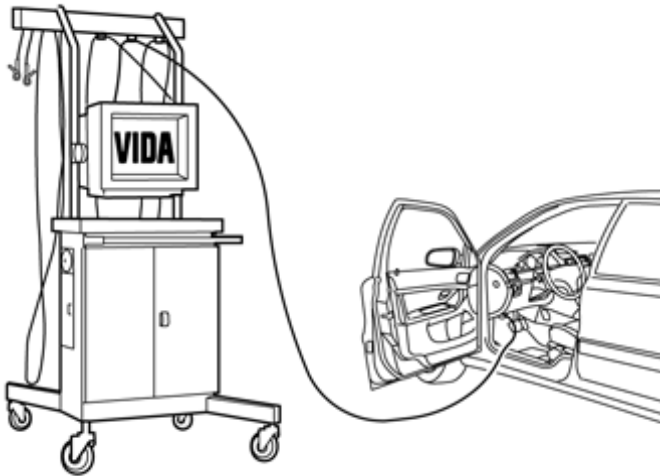

IMG-242268

Download the software for the accessory's function following the service information in VID A.

See VID A or the accessories catalogue for software part number.