



# Installation instructions, accessories

Volvo Car Corporation Gothenburg, Sweden

**Istruzioni No**  
31346082

**Versione**  
1.0

**Part. No.**  
31407107, 31346554, 31350479

## Gancio di traino, centralina TRM



# Installation instructions, accessories

Volvo Car Corporation Gothenburg, Sweden

## Attrezzatura

# VIDA

IMG-242205

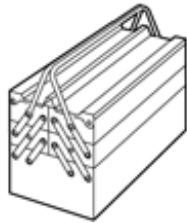

IMG-345497



IMG-332314

MIN.

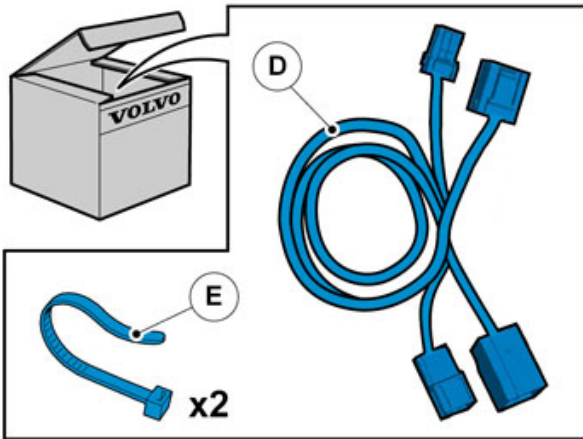
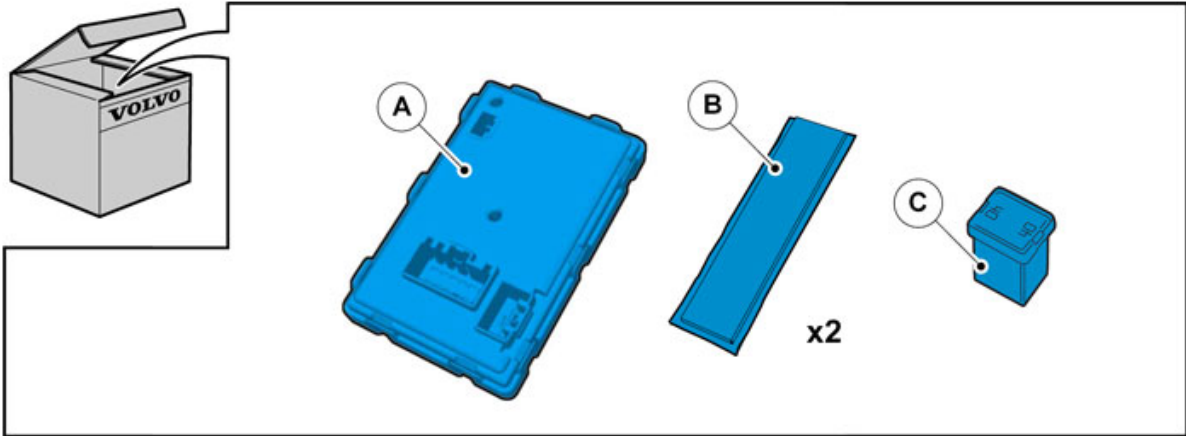

IMG-360181



## INTRODUZIONE

Leggere attentamente tutte le istruzioni prima di iniziare l'installazione.

Le note e i testi di avvertenza sono forniti per la vostra sicurezza e per ridurre al minimo il rischio di rotture in occasione dell'installazione.

Verificare che tutti gli attrezzi specificati nelle istruzioni siano presenti prima di iniziare l'installazione.

Alcune fasi nelle istruzioni sono spiegate solo con le illustrazioni. Per i passaggi più complicati è usato anche un testo esplicativo.

In caso di problemi con le istruzioni o l'accessorio, mettersi in contatto con il concessionario Volvo locale.

1



Portare la chiave di accensione in pos. 0.

### Nota!

Attendere almeno un minuto prima di scollegare i connettori o rimuovere altre apparecchiature elettriche.

IMG-245980



# Installation instructions, accessories

Volvo Car Corporation Gothenburg, Sweden

2

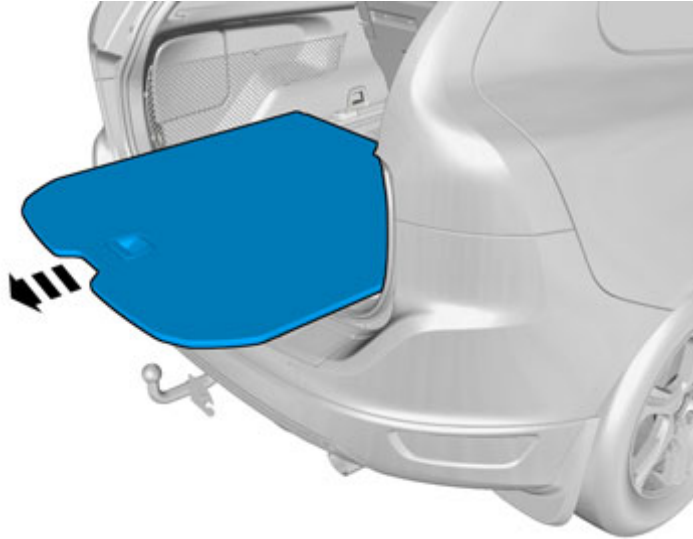

IMG-346921

3



IMG-346811



# Installation instructions, accessories

Volvo Car Corporation Gothenburg, Sweden

4



IMG-360187

5

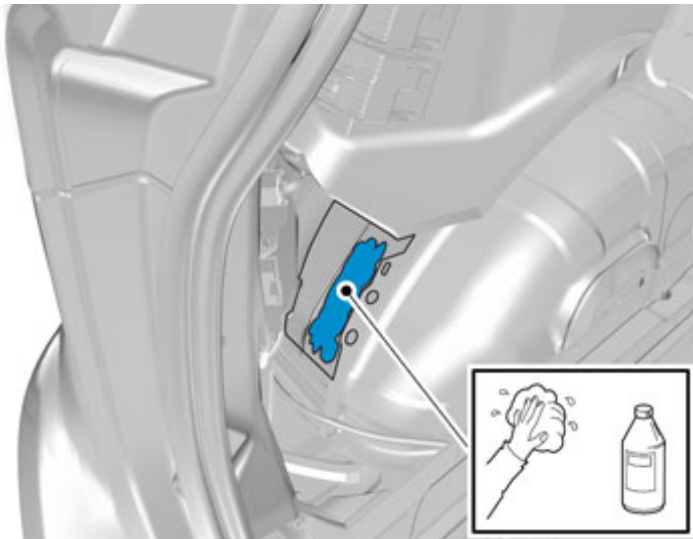

IMG-362267

Usare: Isopropanol, codice articolo 116172

Asciugare con un panno.



# Installation instructions, accessories

Volvo Car Corporation Gothenburg, Sweden

6

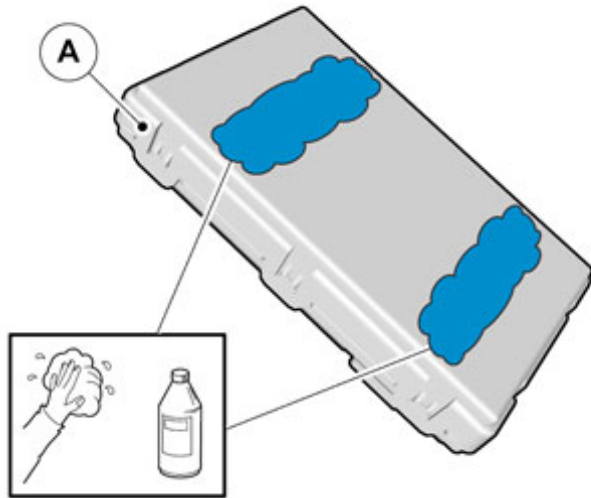

IMG-356179

Usare: Isopropanol, codice articolo 1161721

Asciugare con un panno.

7

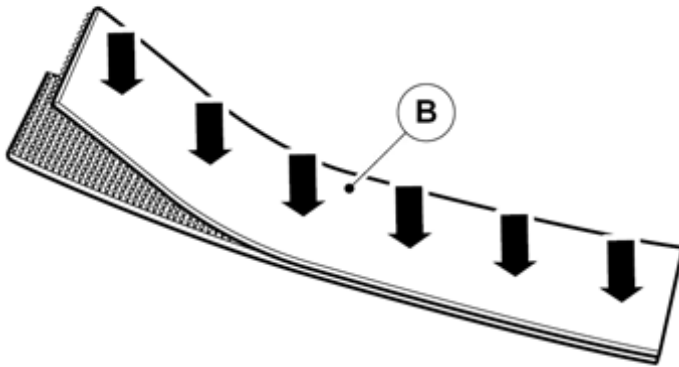

IMG-356181



# Installation instructions, accessories

Volvo Car Corporation Gothenburg, Sweden

8

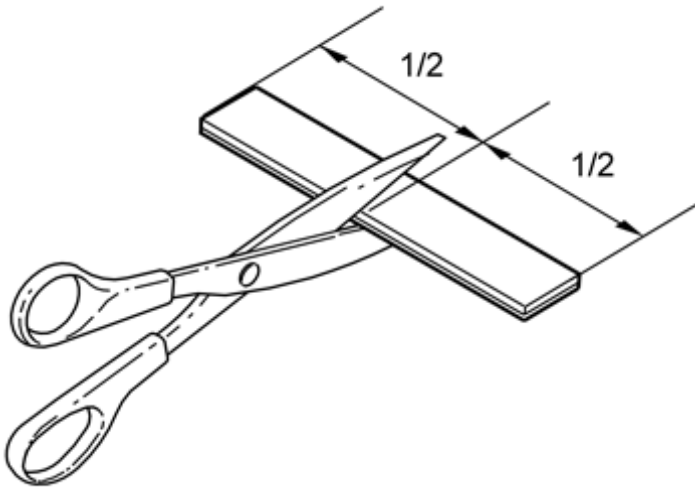

IMG-222282

9

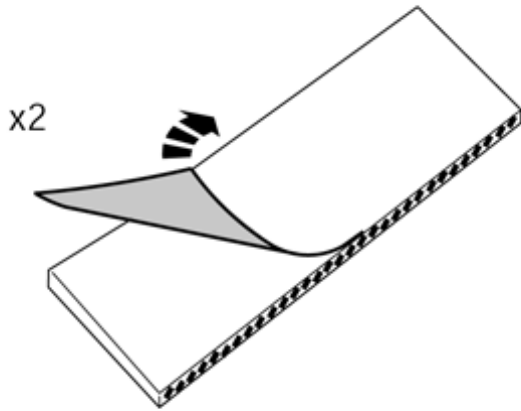

IMG-241925



# Installation instructions, accessories

Volvo Car Corporation Gothenburg, Sweden

10

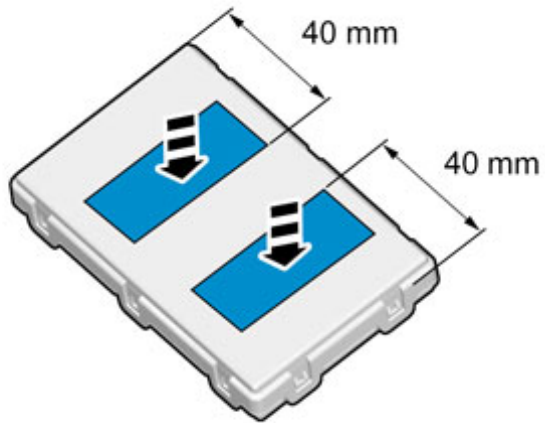

Per l'installazione del nastro Velcro, la base di installazione deve mantenere una temperatura costante di almeno +20° C (68°F).

IMG-356351

11

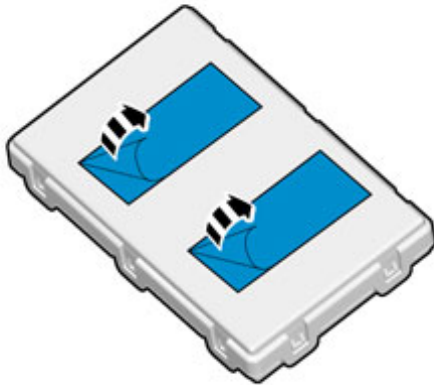

IMG-356352





# Installation instructions, accessories

Volvo Car Corporation Gothenburg, Sweden

12

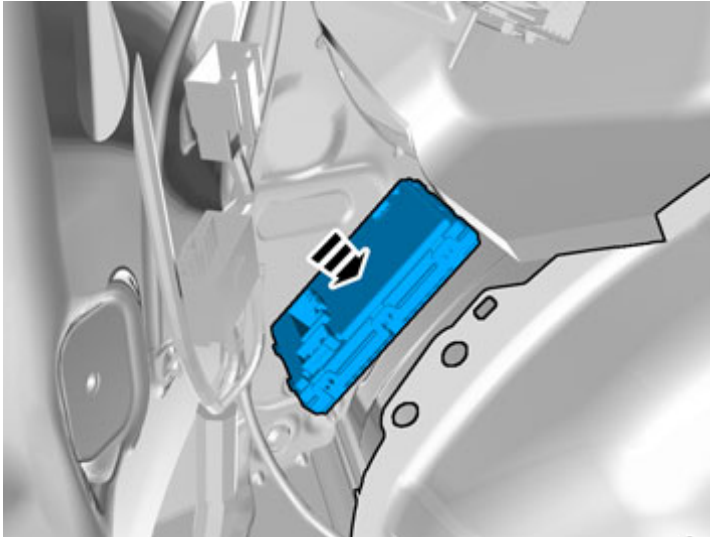

IMG-362292

Fissare a pressione la centralina.

Per l'installazione del nastro Velcro, la base di installazione deve mantenere una temperatura costante di almeno +20° C (68°F).

13

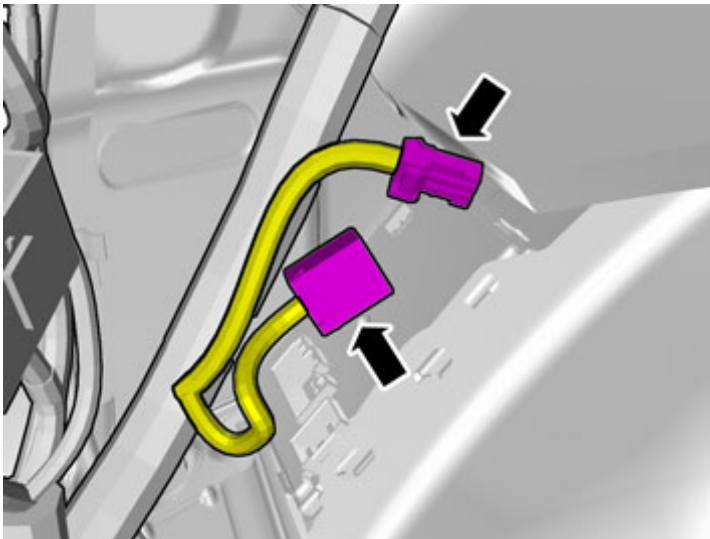

IMG-362298

**Vale per i veicoli con anno di modello a partire dal 2013-**

Localizzare i connettori nella struttura posteriore dell'auto.



# Installation instructions, accessories

Volvo Car Corporation Gothenburg, Sweden

14

Collegare i connettori localizzati.

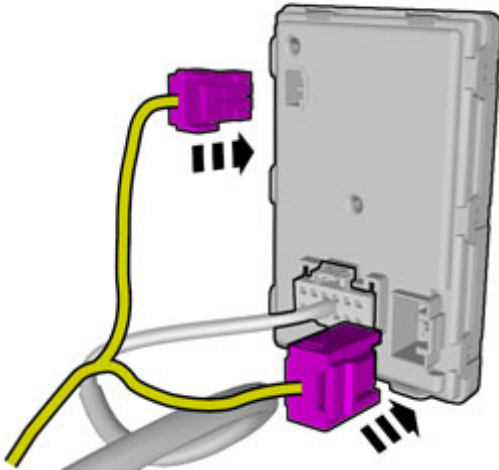

IMG-362296

15

**Vale per i veicoli con anno di modello fino al -2012**

Scostare via l'isolamento.

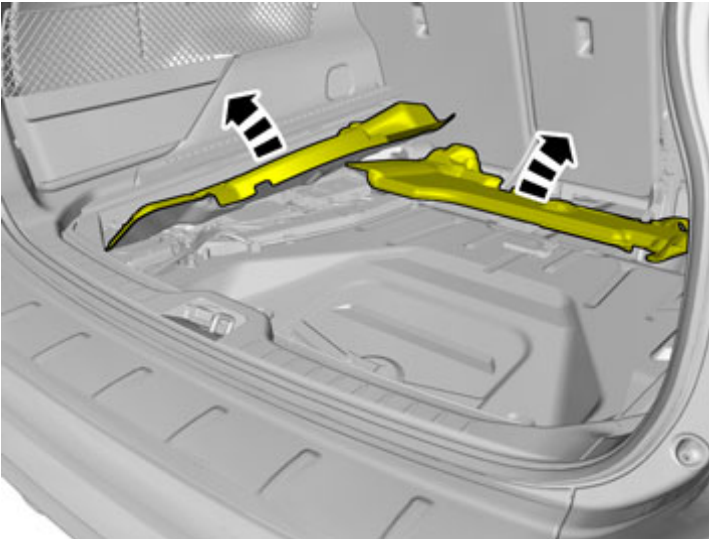

IMG-347027



# Installation instructions, accessories

Volvo Car Corporation Gothenburg, Sweden

16

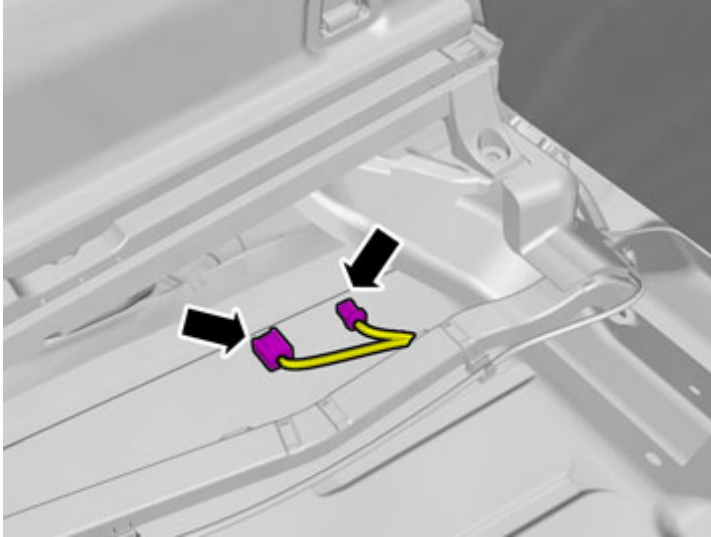

IMG-362307

Localizzare i connettori.

17

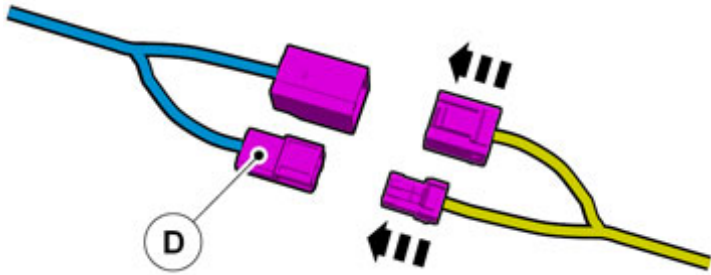

IMG-360183

Collegare il cablaggio di prolunga ai connettori localizzati.



# Installation instructions, accessories

Volvo Car Corporation Gothenburg, Sweden

18

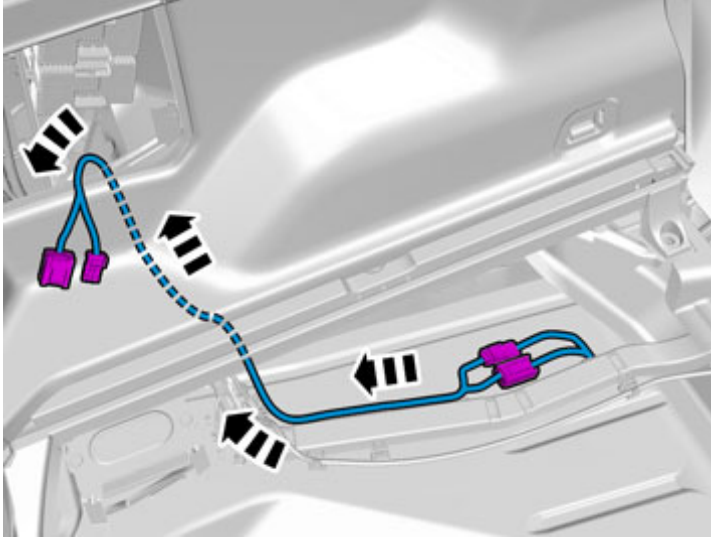

IMG-362318

Far scorrere il cablaggio di prolunga lungo il cablaggio esistente.

19

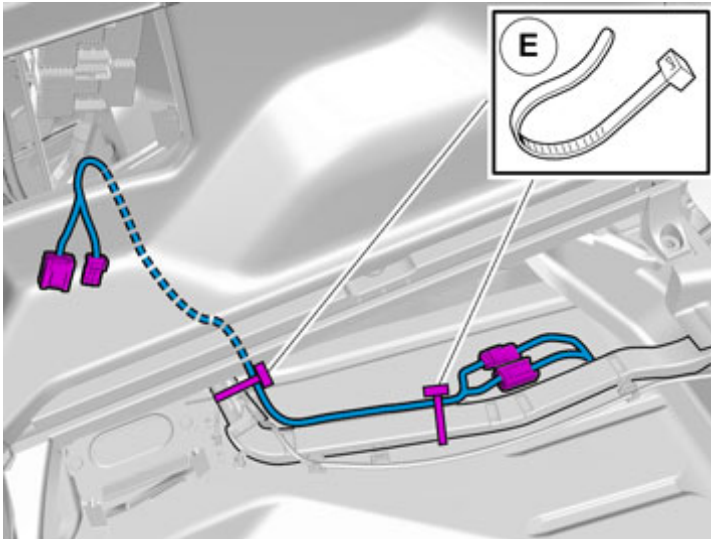

IMG-362319

Far scorrere il cablaggio di prolunga lungo il cablaggio esistente.

Usare fascette serrafili per fissare l'eventuale lunghezza eccedente.



# Installation instructions, accessories

Volvo Car Corporation Gothenburg, Sweden

20

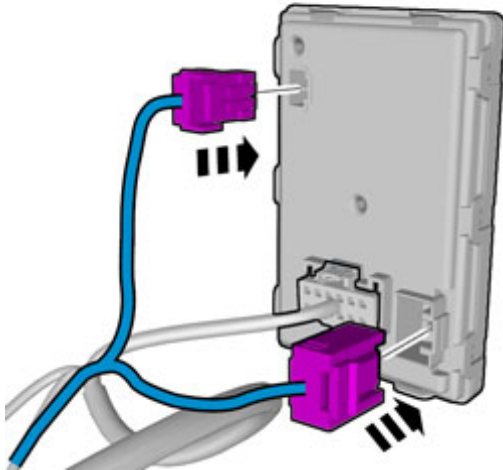

IMG-359922

Collegare i connettori dal cablaggio di prolunga alla centralina.

21

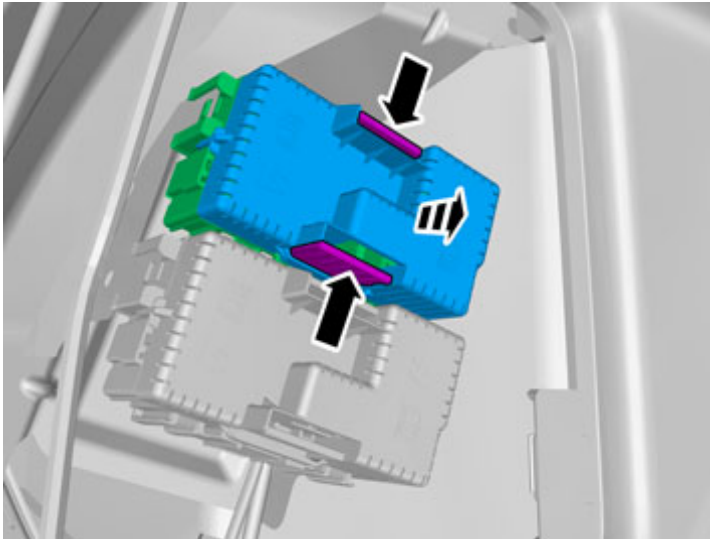

IMG-360189

**Vale per tutte le vetture**

Premere in dentro i fermi sul coperchio nero della bassetta portafusibili e rimuoverlo.



# Installation instructions, accessories

Volvo Car Corporation Gothenburg, Sweden

22

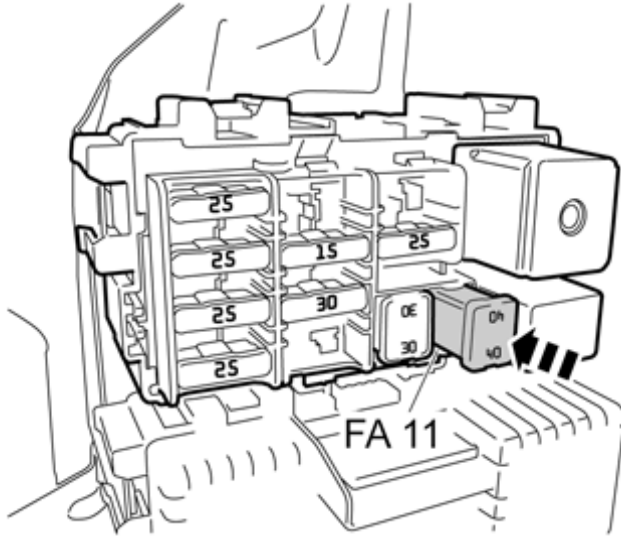

IMG-285841

Montare un fusibile da 40A in posizione FA 11 nel modulo RJB-A.

Rimontare il coperchio.

23

Rimettere a posto i dettagli staccati in ordine inverso.

24

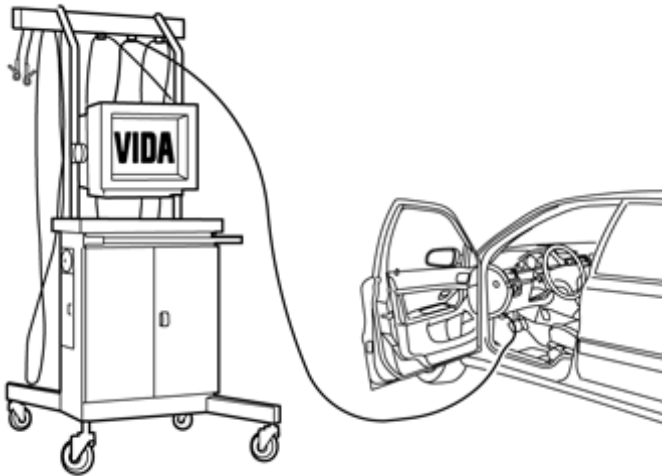

IMG-242268

Scaricare il software (applicazione) per il funzionamento dell'accessorio seguendo le indicazioni per l'assistenza in VIDA.

Vedere VIDA o il catalogo dei ricambi per il codice componente del software.