

Installation instructions, accessories

Volvo Car Corporation Gothenburg, Sweden

Istruzioni No
31399138

Versione
1.0

Part. No.
31399137

Impianto di scarico sportivo, R-design



IMG-382135

Attrezzatura

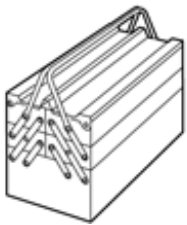

IMG-345497



IMG-244944



IMG-239981

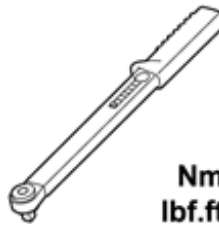

IMG-239664

Nm
lbf.ft

Installation instructions, accessories

Volvo Car Corporation Gothenburg, Sweden

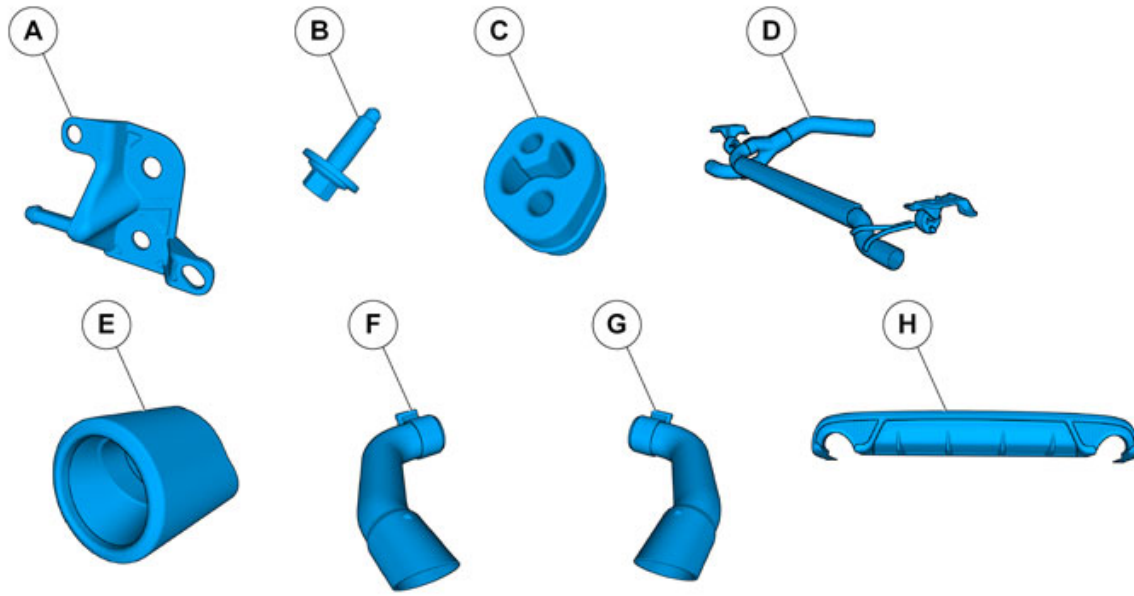

IMG-382132

Installation instructions, accessories

Volvo Car Corporation Gothenburg, Sweden

Informazioni

1

Altre informazioni

2

Leggere attentamente tutte le istruzioni prima di iniziare l'installazione.

Le note e i testi di avvertenza sono forniti per la vostra sicurezza e per ridurre al minimo il rischio di rotture in occasione dell'installazione.

Verificare che tutti gli attrezzi specificati nelle istruzioni siano presenti prima di iniziare l'installazione.

Alcune fasi nelle istruzioni sono spiegate solo con le illustrazioni. Per i passaggi più complicati è usato anche un testo esplicativo.

In caso di problemi con le istruzioni o l'accessorio, mettersi in contatto con il concessionario Volvo locale.

3

Nota!

I tubi di scarico devono essere installati insieme al diffusore.

Simbolismo dei colori

4

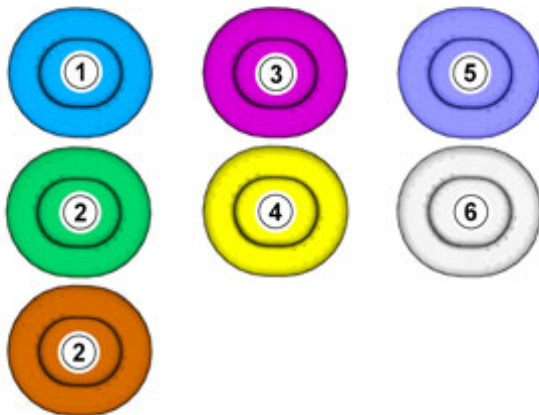

1. Si utilizza per evidenziare il componente in questione.
2. Si utilizzano come colori supplementari quando si intende mostrare o distinguere più componenti.
3. Si utilizza per gli elementi di fissaggio che devono essere rimossi/montati, ad esempio viti, fermagli e connettori.
4. Si usa quando il componente non è completamente rimosso dal veicolo, ma è sospeso solamente di lato.
5. Si utilizza per attrezzi standard e attrezzi speciali.
6. Si utilizza come colore di sfondo dei componenti dell'automobile.

IMG-363036

Rimozione

Installation instructions, accessories

Volvo Car Corporation Gothenburg, Sweden

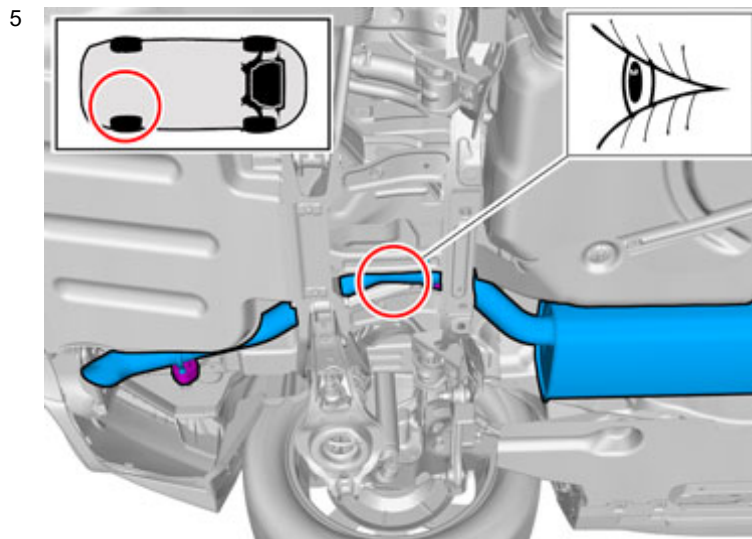

IMG-357842

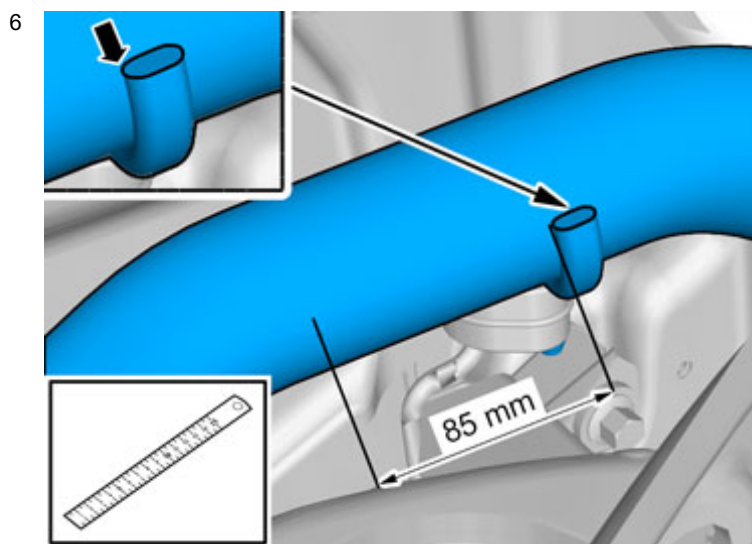

IMG-368166

Installation instructions, accessories

Volvo Car Corporation Gothenburg, Sweden

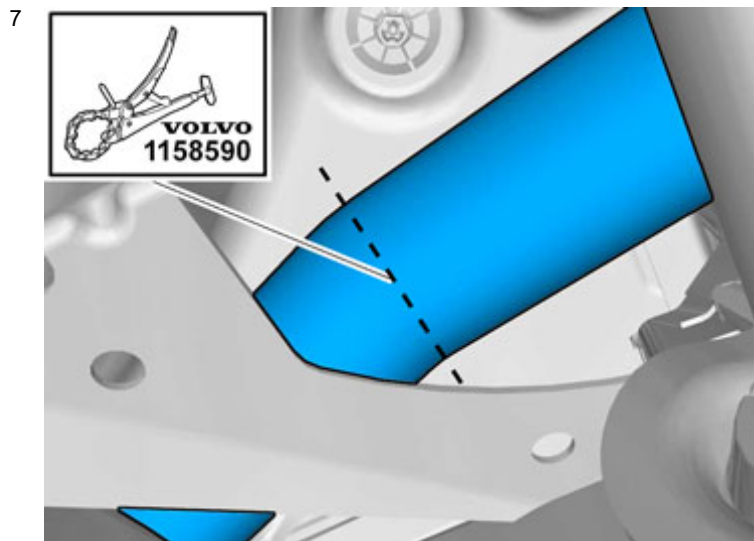

IMG-368167

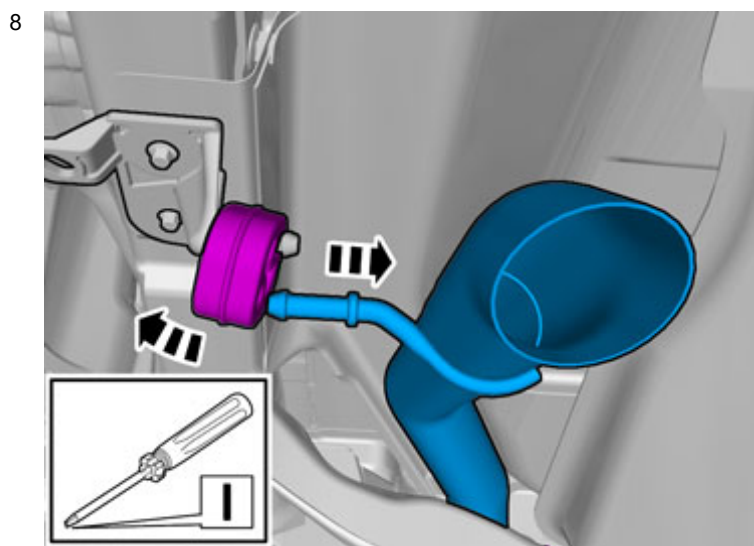

IMG-357534

Installazione

Installation instructions, accessories

Volvo Car Corporation Gothenburg, Sweden

9

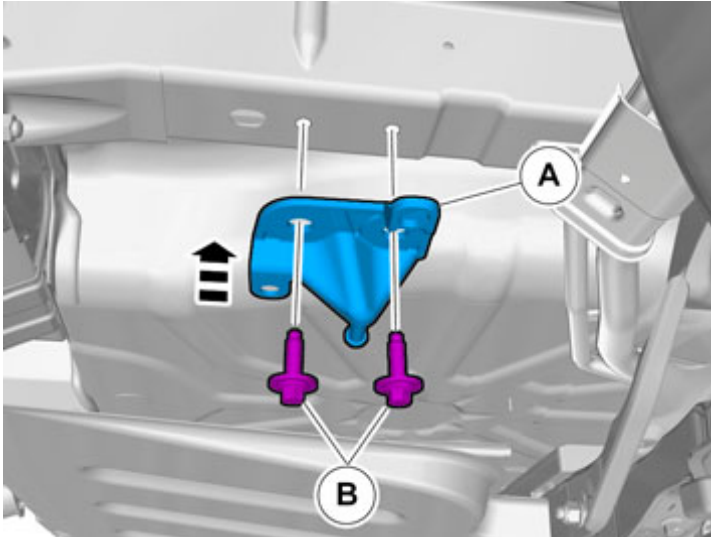

IMG-357541

10

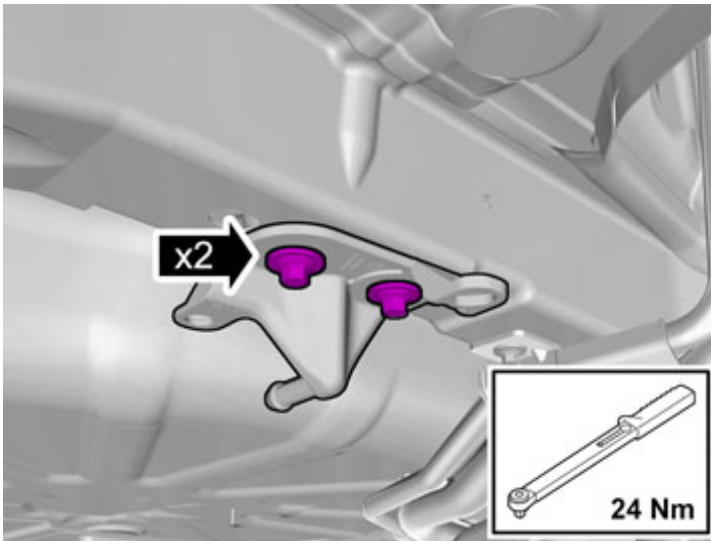

IMG-357576

Installation instructions, accessories

Volvo Car Corporation Gothenburg, Sweden

11

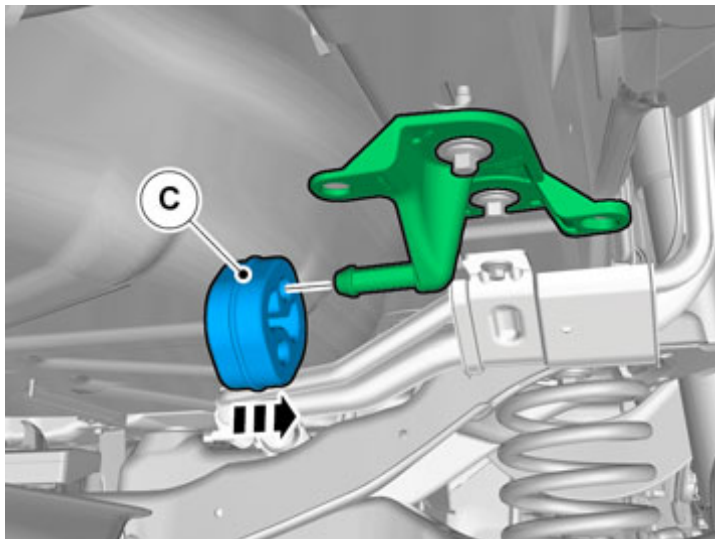

IMG-357577

12

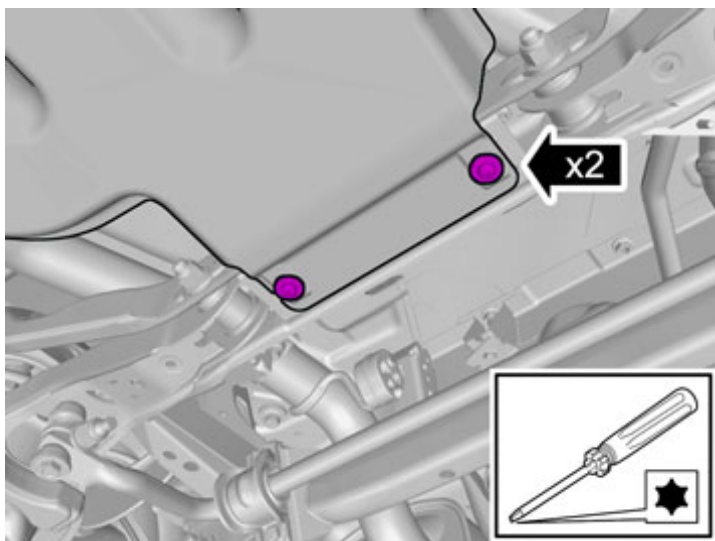

IMG-357498

Rimuovere le viti.

Installation instructions, accessories

Volvo Car Corporation Gothenburg, Sweden

13

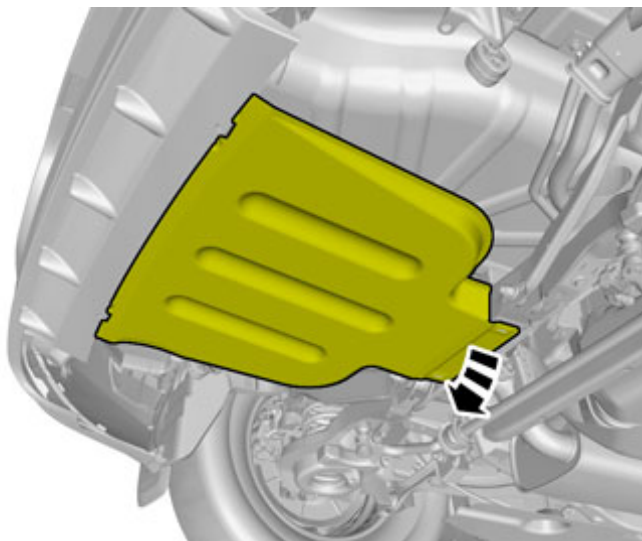

IMG-357586

14

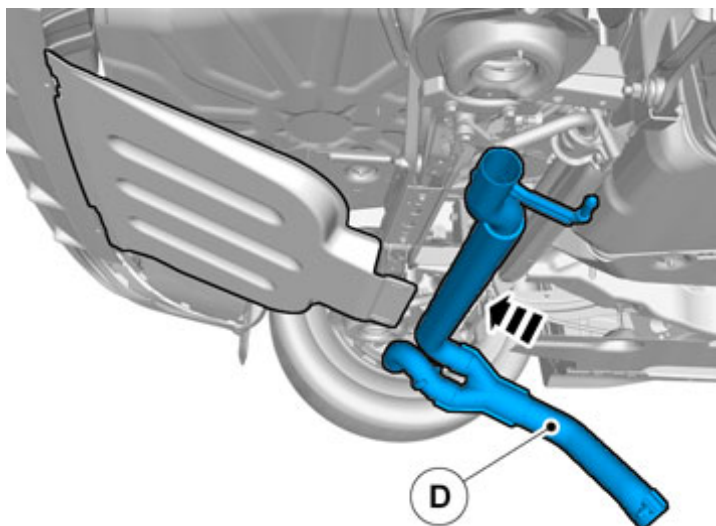

IMG-357589

Installation instructions, accessories

Volvo Car Corporation Gothenburg, Sweden

15

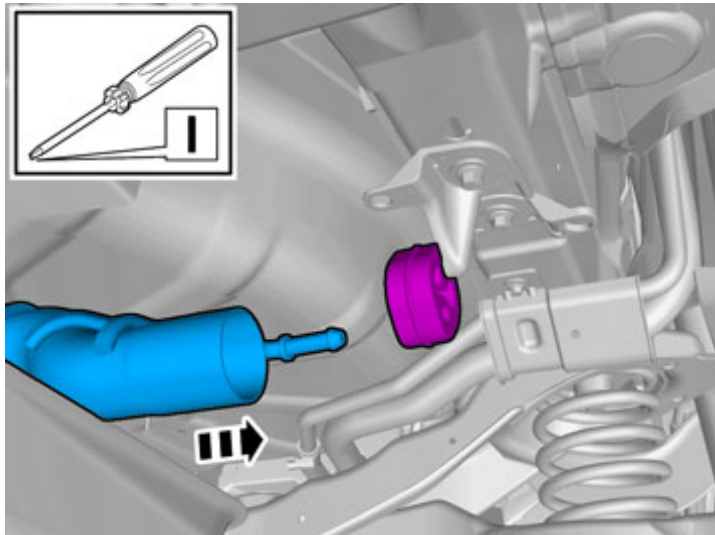

IMG-357591

16

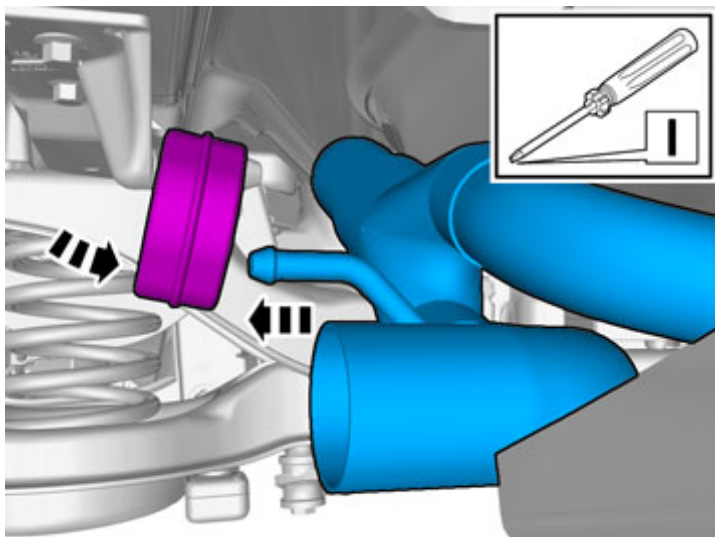

IMG-357592

Installation instructions, accessories

Volvo Car Corporation Gothenburg, Sweden

17

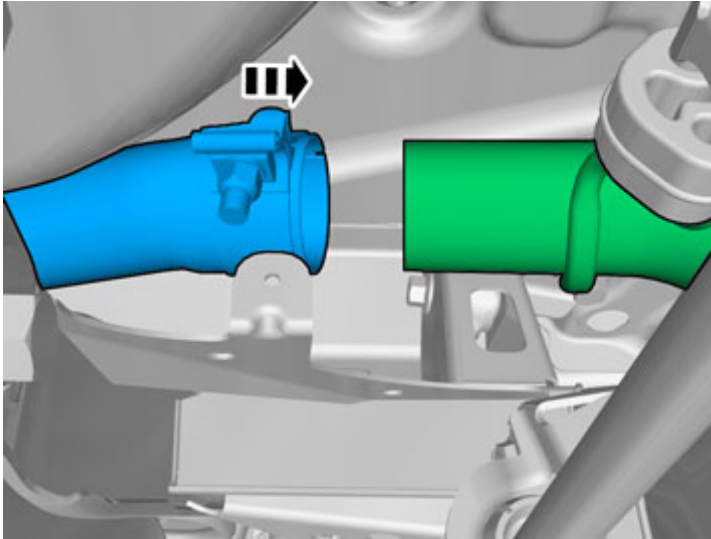

IMG-357600

18

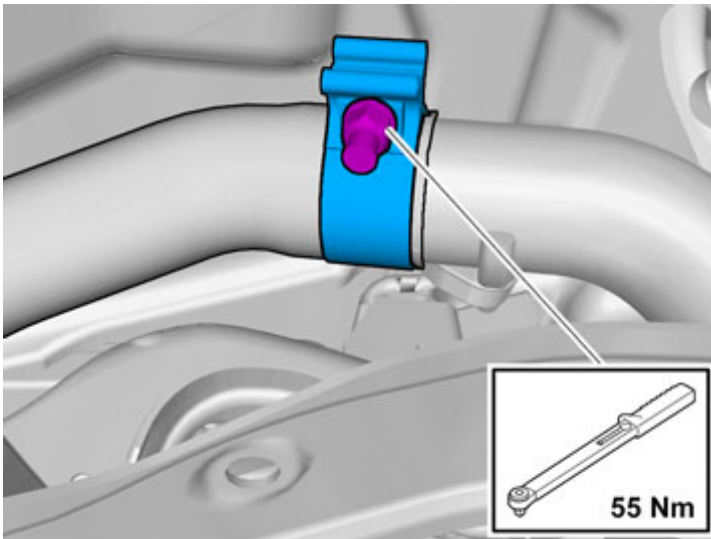

IMG-357853

Installation instructions, accessories

Volvo Car Corporation Gothenburg, Sweden

19

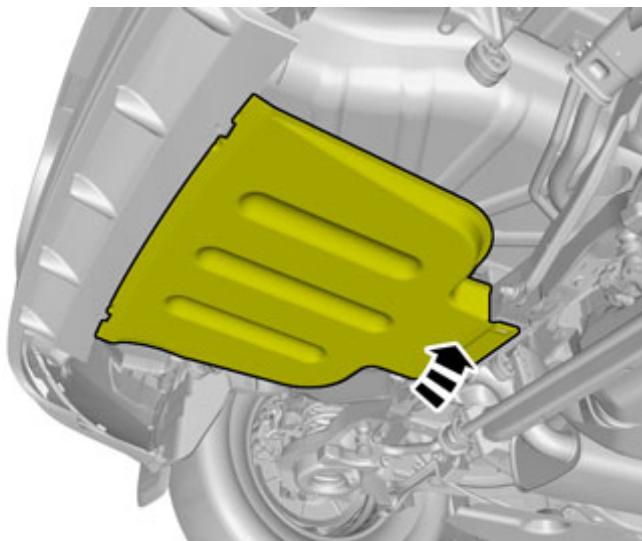

IMG-357691

20

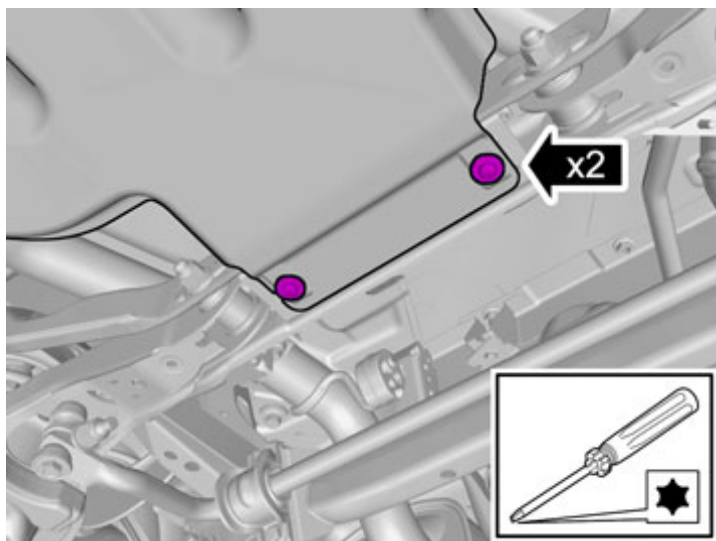

IMG-357498

Rimettere a posto le viti.

Installation instructions, accessories

Volvo Car Corporation Gothenburg, Sweden

21

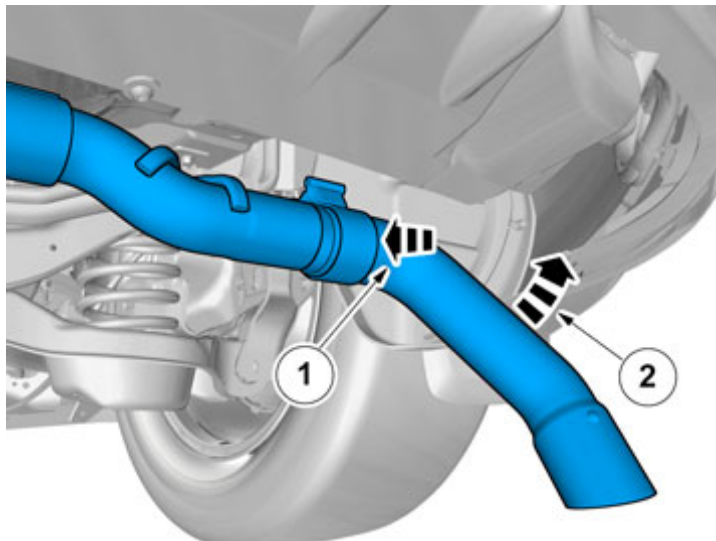

IMG-382349

Ripetere sull'altro lato.

22

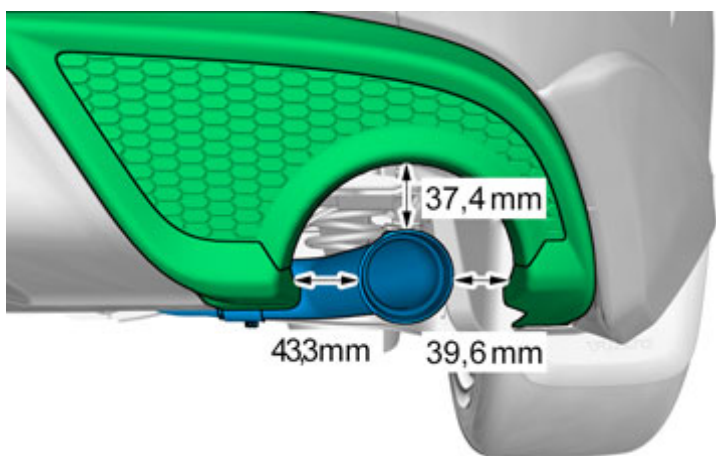

IMG-382433

Ripetere sull'altro lato.

Installation instructions, accessories

Volvo Car Corporation Gothenburg, Sweden

23

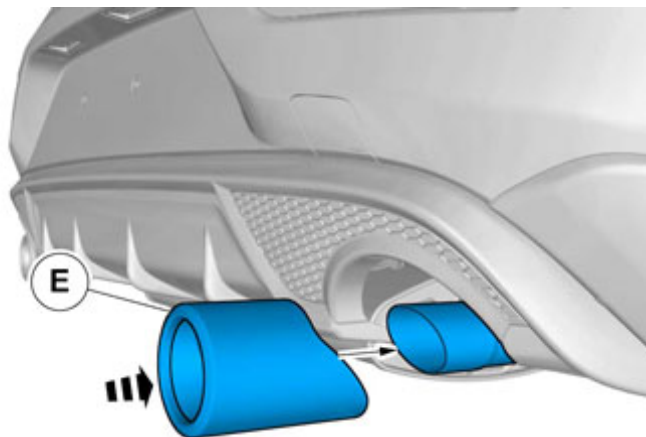

Ripetere sull'altro lato.

IMG-382120

Rimozione

24

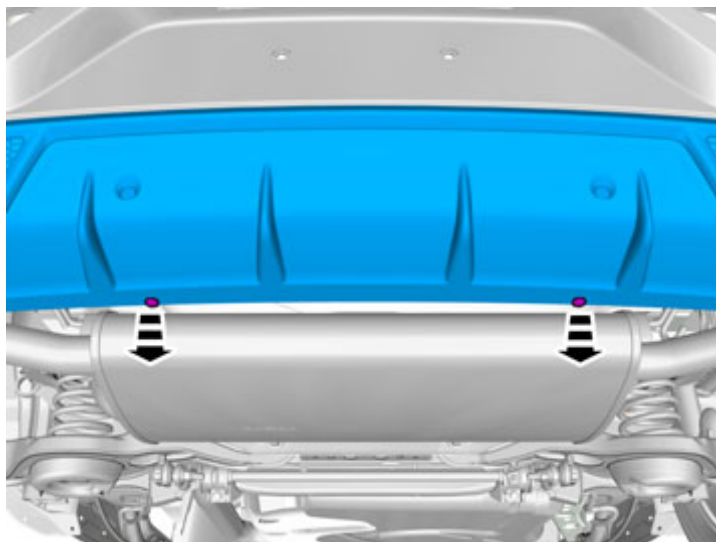

Rimuovere le viti.

IMG-376535

Installation instructions, accessories

Volvo Car Corporation Gothenburg, Sweden

25

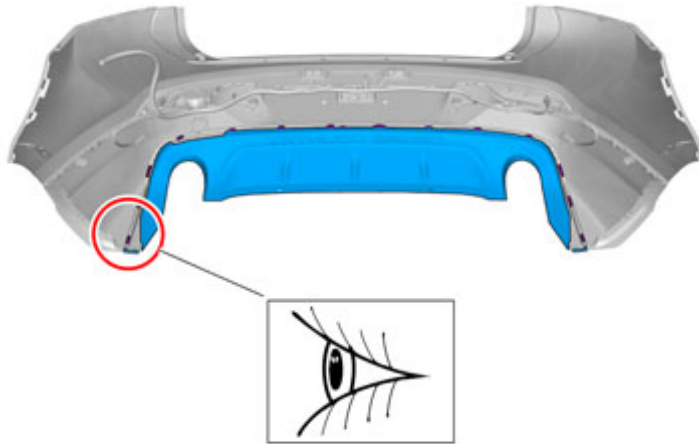

Nota!
Vista orientativa

IMG-356081

26

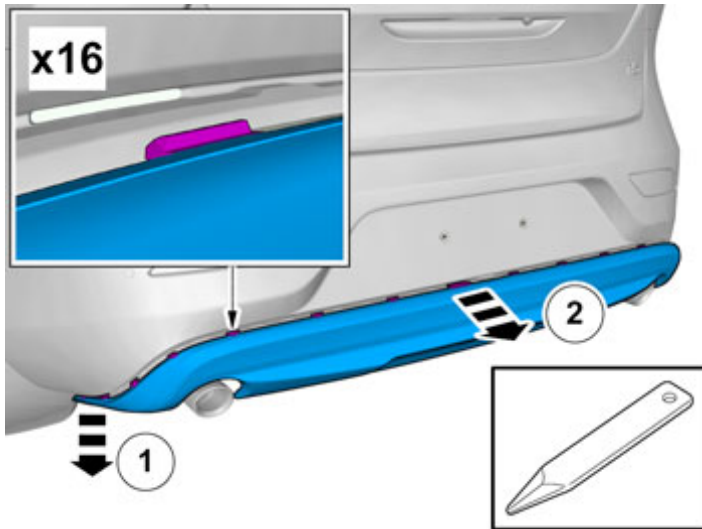

IMG-376222

Veicoli con Ausilio al parcheggio

Installation instructions, accessories

Volvo Car Corporation Gothenburg, Sweden

27

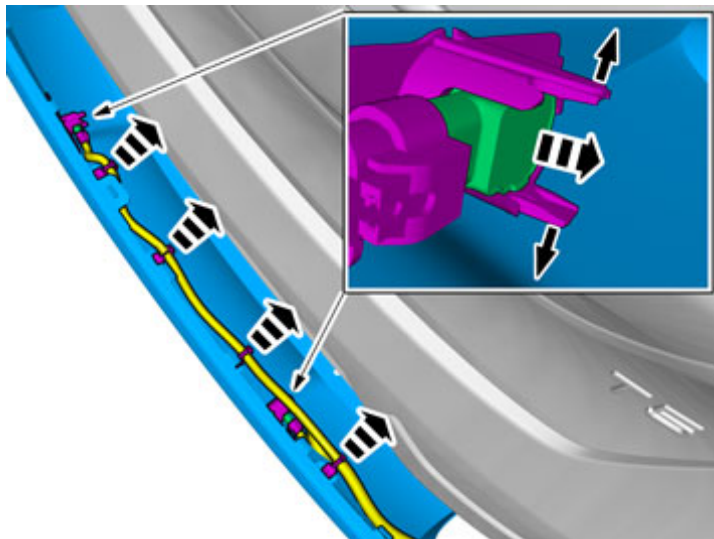

IMG-376229

Attenzione!

Prestare la massima attenzione durante la manipolazione di questi componenti.

Sganciare i fermagli del cablaggio.

Staccare cautamente il dettaglio

Riutilizzare il componente esistente.