

Installation instructions, accessories

Volvo Car Corporation Gothenburg, Sweden

Instruction No 30756784 **Version** 1.1 **Part. No.** 30756667

Bumper cover



IMG-345661

Materials

Designation	Part number
Isopropanol	1161721

Equipment

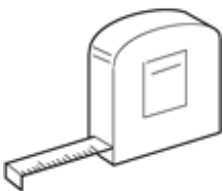

IMG-244945

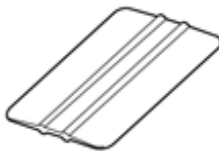

IMG-221380

Installation instructions, accessories

Volvo Car Corporation Gothenburg, Sweden

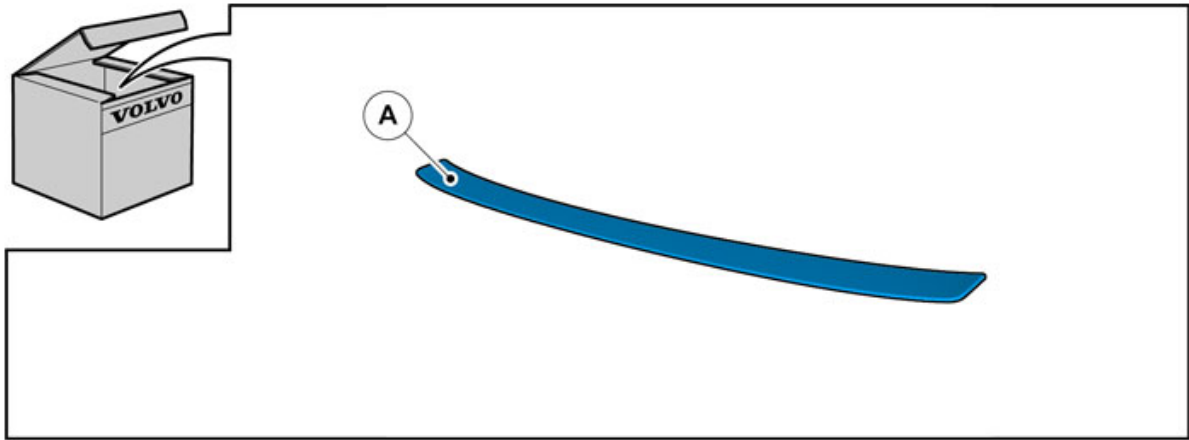

IMG-345638

Installation instructions, accessories

Volvo Car Corporation Gothenburg, Sweden

Information

1

Read through all of the instructions before starting installation.

Notifications and warning texts are for your safety and to minimise the risk of something breaking during installation.

Ensure that all tools stated in the instructions are available before starting installation.

Certain steps in the instructions are only presented in the form of images. Explanatory text is also given for more complicated steps.

In the event of any problems with the instructions or the accessory, contact your local Volvo dealer.

Conditions

2

When installing, the car must retain a temperature of 20 degrees C.

After installation, the car must not be driven for 2 hours

After installation, the car must not be washed for 48 hours

3

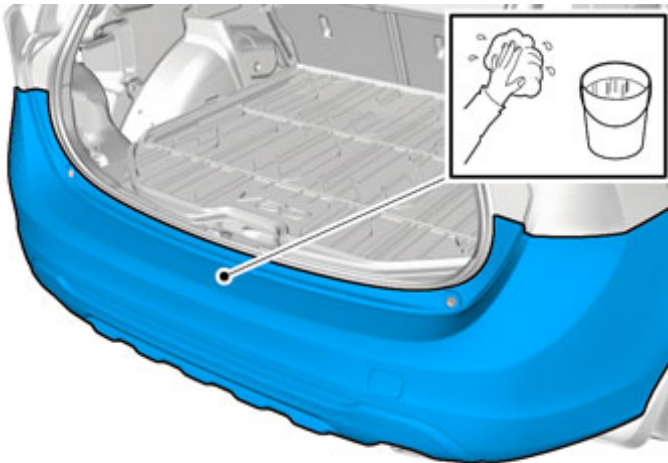

Clean the surface.

Allow to dry.

IMG-345642

Installation instructions, accessories

Volvo Car Corporation Gothenburg, Sweden

4

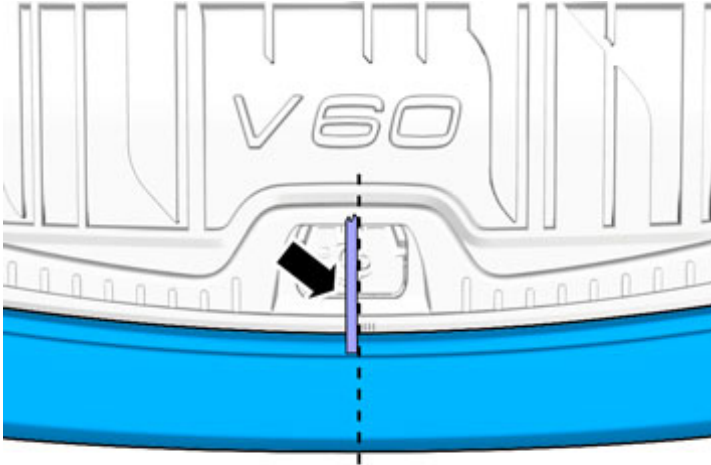

Use suitable tape to indicate the center.

IMG-345625

5

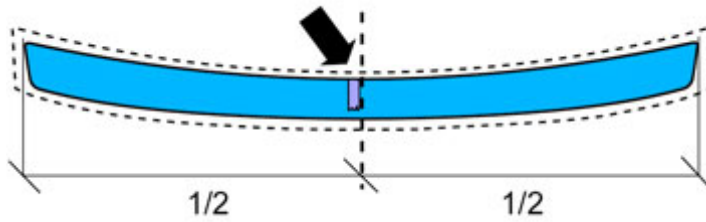

Use suitable tape to indicate the center.

IMG-345626

Installation instructions, accessories

Volvo Car Corporation Gothenburg, Sweden

6

Cut off a piece of the transparent foil, as indicated.

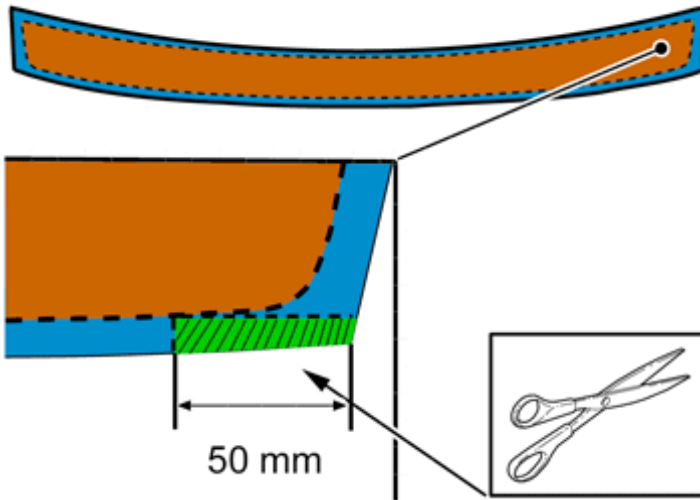

IMG-345624

7

Cut off a piece of the transparent foil, as indicated.

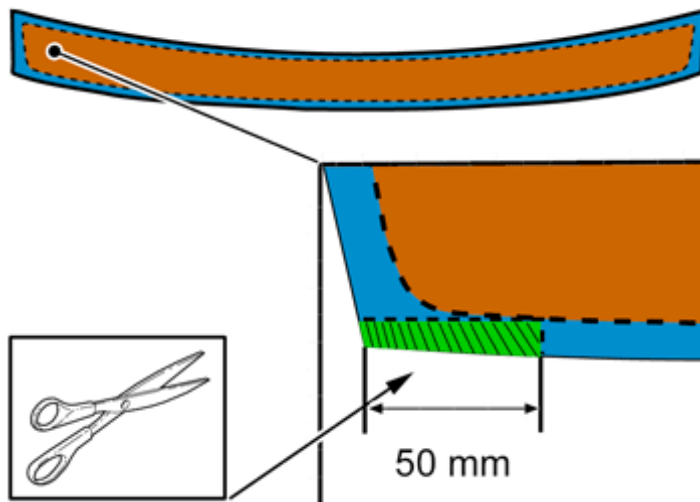

IMG-345997

Installation instructions, accessories

Volvo Car Corporation Gothenburg, Sweden

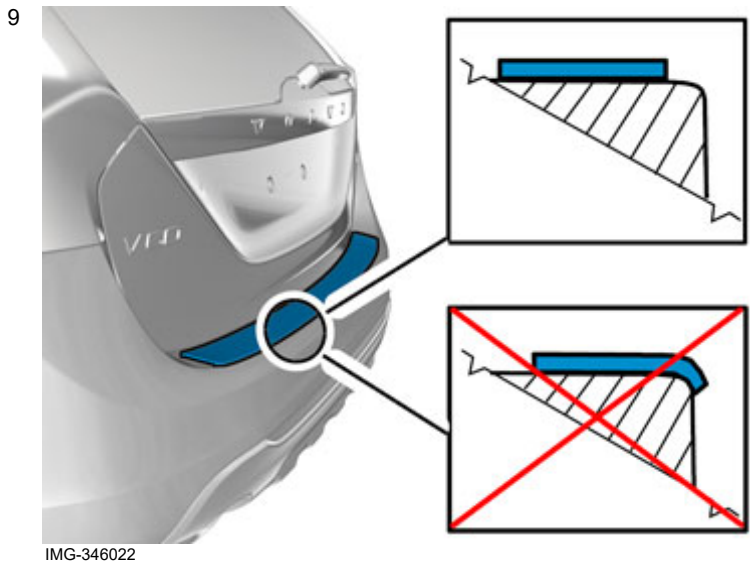
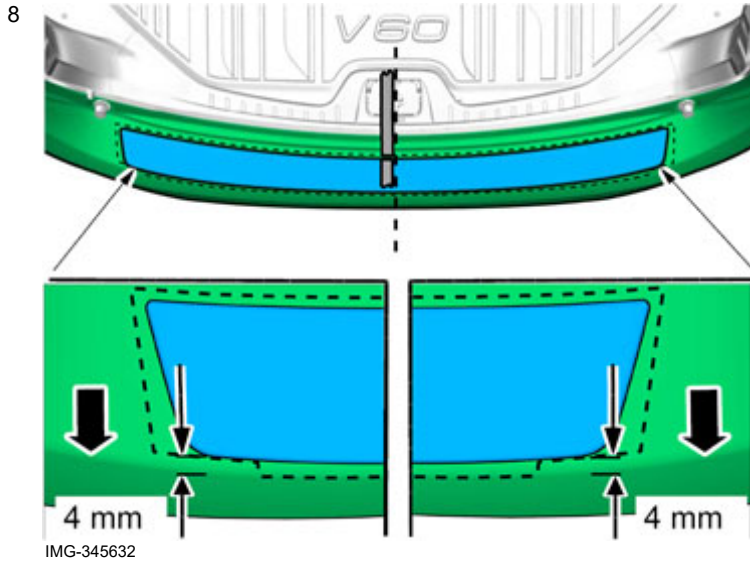

Installation instructions, accessories

Volvo Car Corporation Gothenburg, Sweden

10

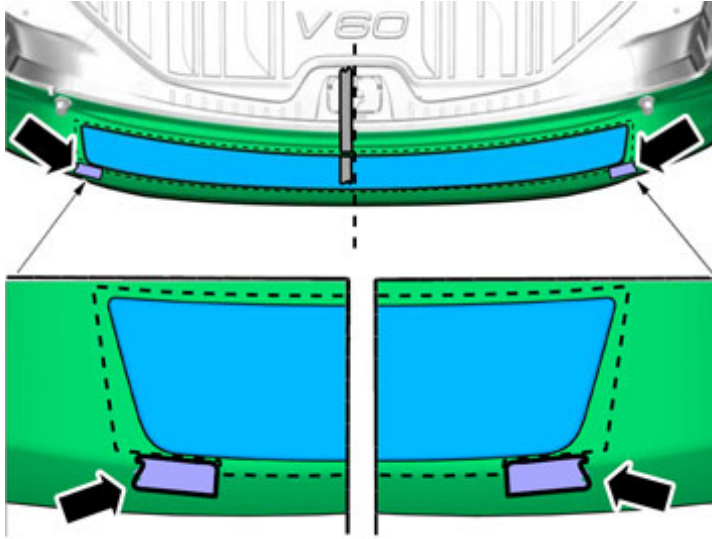

IMG-345641

Use appropriate tape to mark the position.

11

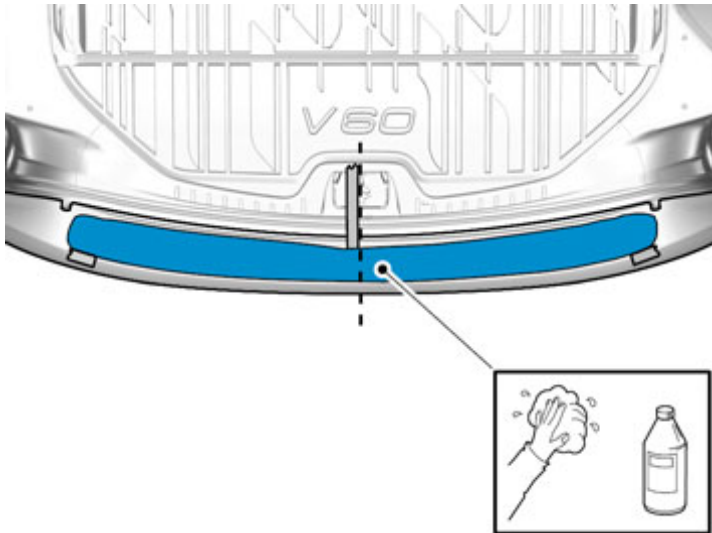

IMG-345636

Clean the Bumper Cover surface.

Allow to dry.

Use: 1161721, Isopropanol

Installation instructions, accessories

Volvo Car Corporation Gothenburg, Sweden

12

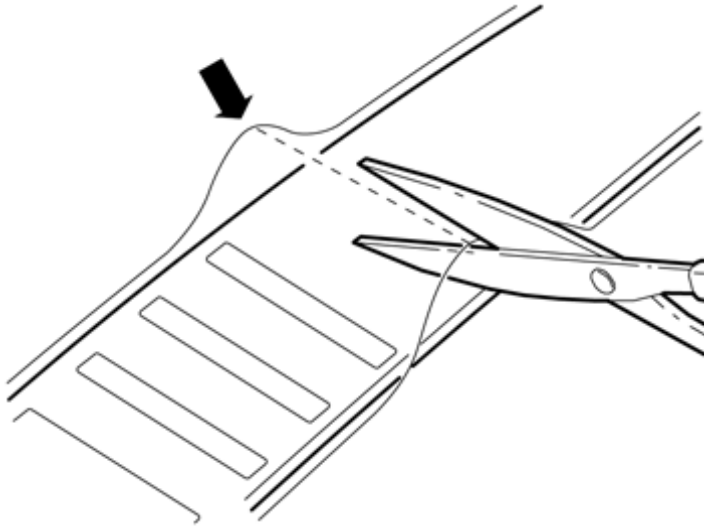

IMG-345623

Cut in the lower transparent foil in the middle.

13

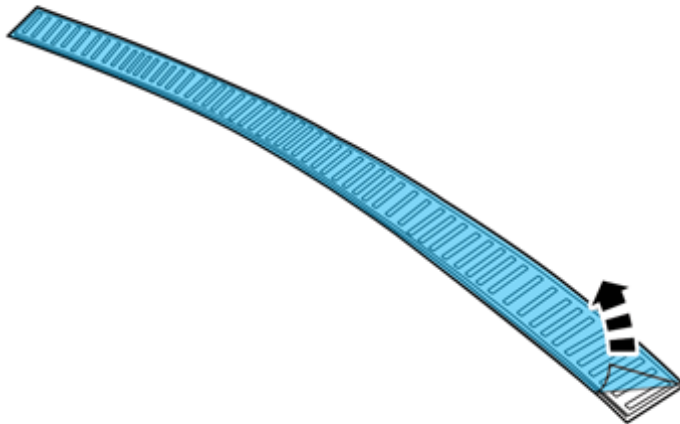

IMG-378604

Pull off the top protection foil, if applicable.

Installation instructions, accessories

Volvo Car Corporation Gothenburg, Sweden

14

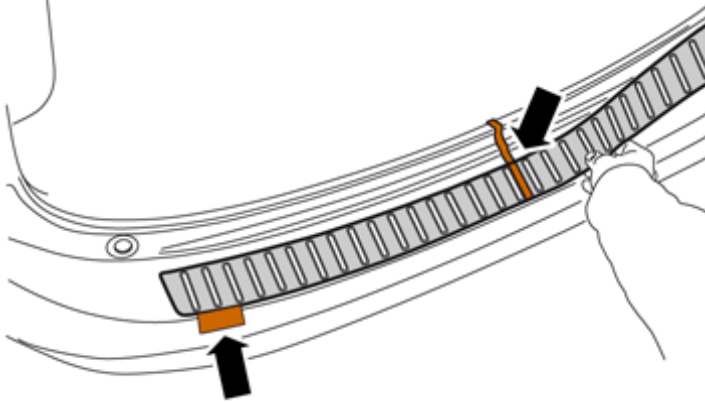

IMG-345942

Adjust the position of the Bumper Protection using the tape marks.

15

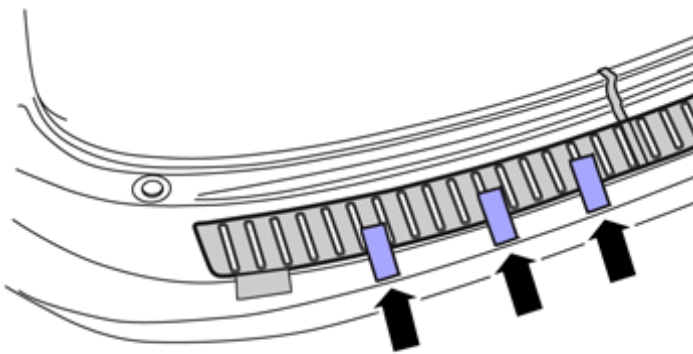

IMG-347431

Note!
Use tape to temporarily fix the bumper cover in the correct position.

Installation instructions, accessories

Volvo Car Corporation Gothenburg, Sweden

16

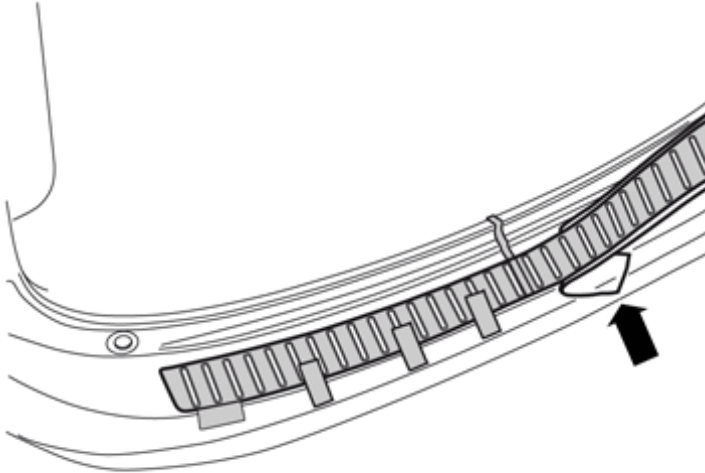

IMG-347451

Note!

Touching the adhesive surface will impair rebonding.

Partly fold back the transparent foil to expose the sticky surface.

17

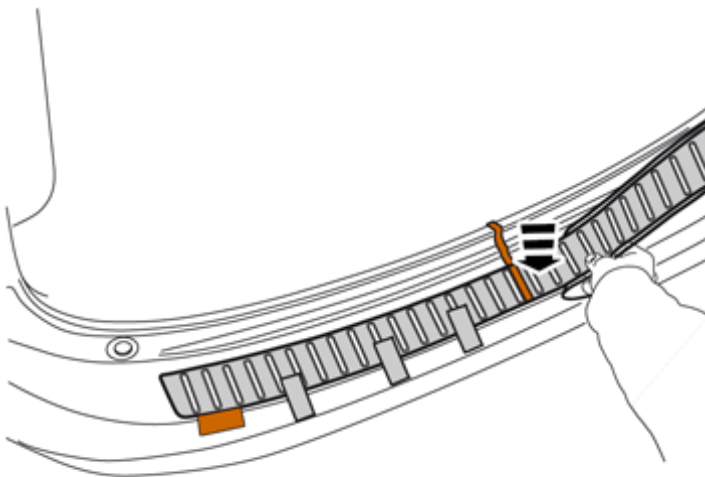

IMG-345943

Allow the Bumper Protection to adhere to the Bumper Cover as indicated.

Installation instructions, accessories

Volvo Car Corporation Gothenburg, Sweden

18

Pull off the rest of the transparent foil and press by hand on the Bumper protection to make it cling to the Bumper Cover.

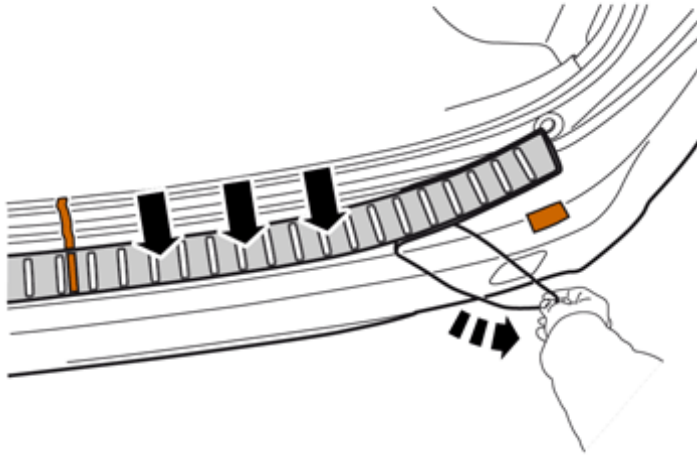

IMG-345944

19

Pull off the rest of the transparent foil and press by hand on the Bumper protection to make it cling to the Bumper Cover.

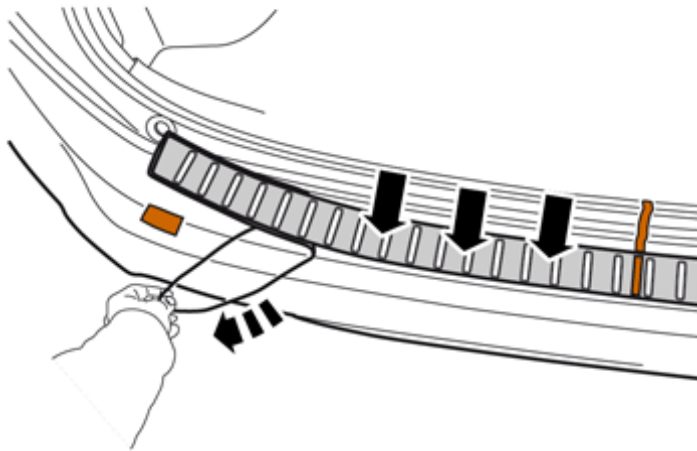

IMG-345945

Installation instructions, accessories

Volvo Car Corporation Gothenburg, Sweden

20

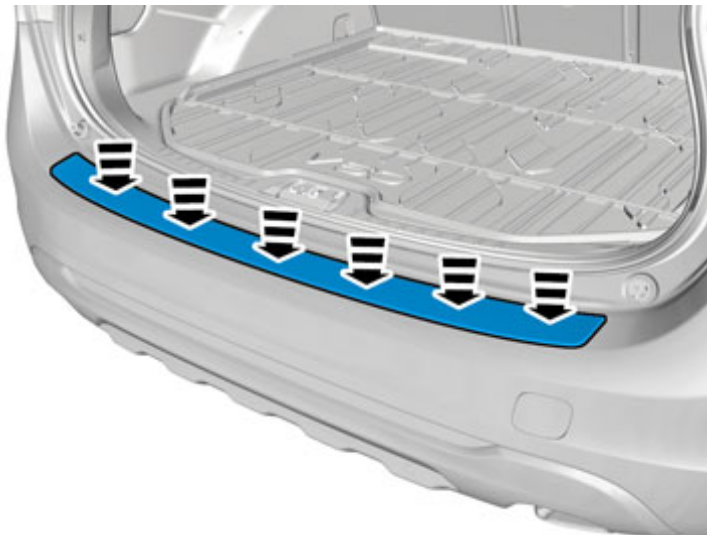

IMG-345646

Thoroughly press, by hand, all over the Bumper Protection to make it cling properly.

Use suitable tool to squeeze out any trapped air bubbles.