



# Installation instructions, accessories

Volvo Car Corporation Gothenburg, Sweden

**Ohje nro**  
31346083

**Versio**  
1.0

**Osa nro**  
31407107, 31350479, 31346554

## Vetokoukku, ohjausyksikkö (TRM)



# Installation instructions, accessories

Volvo Car Corporation Gothenburg, Sweden

## Varuste

# VIDA

IMG-242205

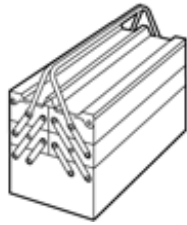

IMG-345497



IMG-332314



IMG-239664

Nm  
lbf.ft

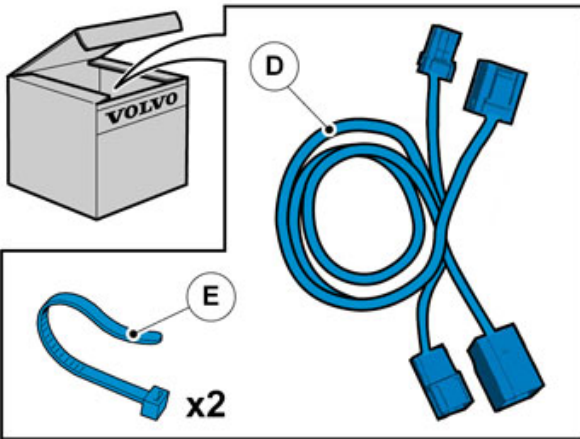
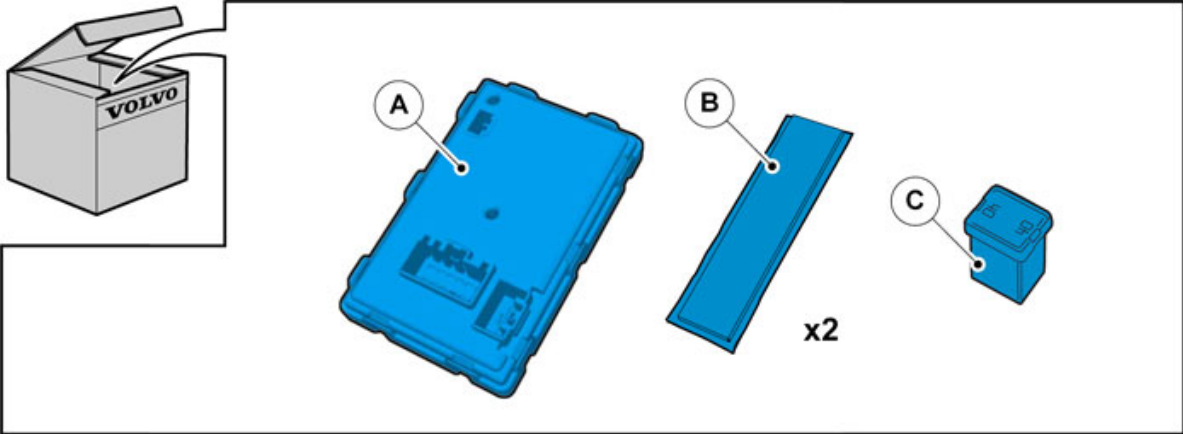

IMG-360181



# Installation instructions, accessories

Volvo Car Corporation Gothenburg, Sweden

## JOHDANTO

Lue läpi koko ohje ennen asennuksen aloittamista.

Huomautukset ja varoitustekstit ovat turvallisuuden takia ja sen vaaran minimoimiseksi, että jotakin menisi rikki asennuksen yhteydessä.

Varmista ennen asennuksen aloittamista, että kaikki ohjeessa mainitut työkalut ovat saatavilla.

Toiset ohjeen työvaiheet esitetään vain kuvin. Monimutkaisemmissa työvaiheissa on myös selostusteksti.

Mahdollisissa ohjeita tai varustetta koskevissa ongelmissa ota yhteyttä paikalliseen Volvo-myyjään.

1



IMG-245980

Aseta virta-avain asentoon 0.

### Huom!

Odota vähintään minuutti, ennen kuin irrotat liittimen tai poistat muun sähkövarusteen.

**Malli S60**



# Installation instructions, accessories

Volvo Car Corporation Gothenburg, Sweden

2

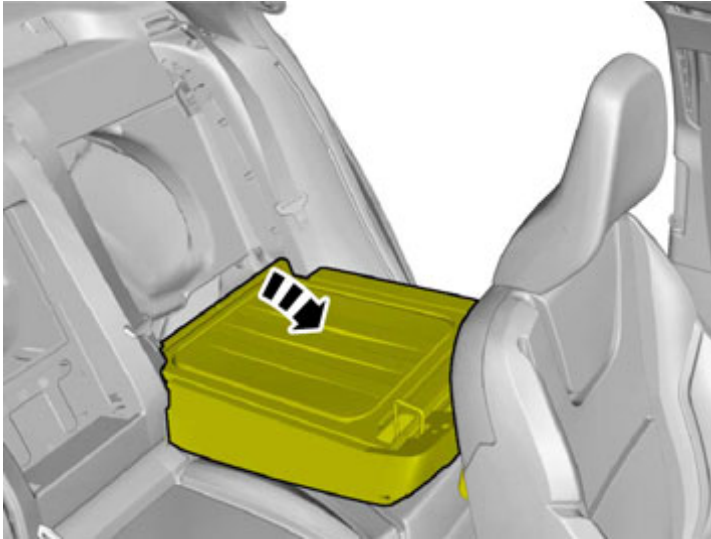

Malli S60

IMG-339894

3

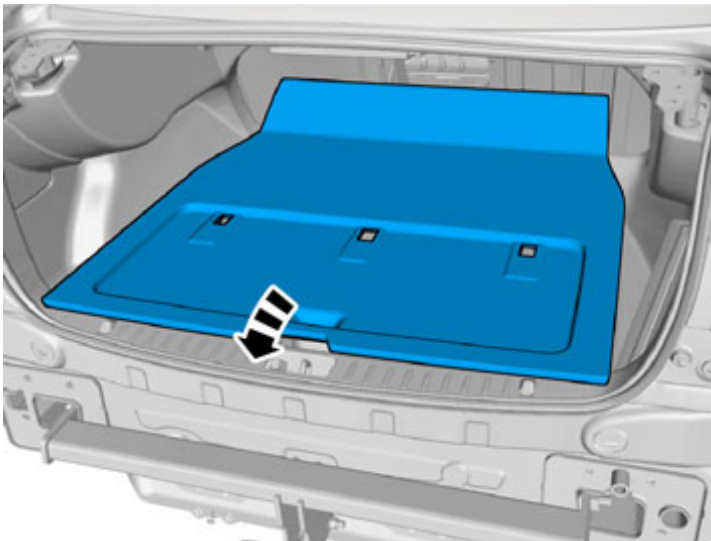

IMG-340180



# Installation instructions, accessories

Volvo Car Corporation Gothenburg, Sweden

4

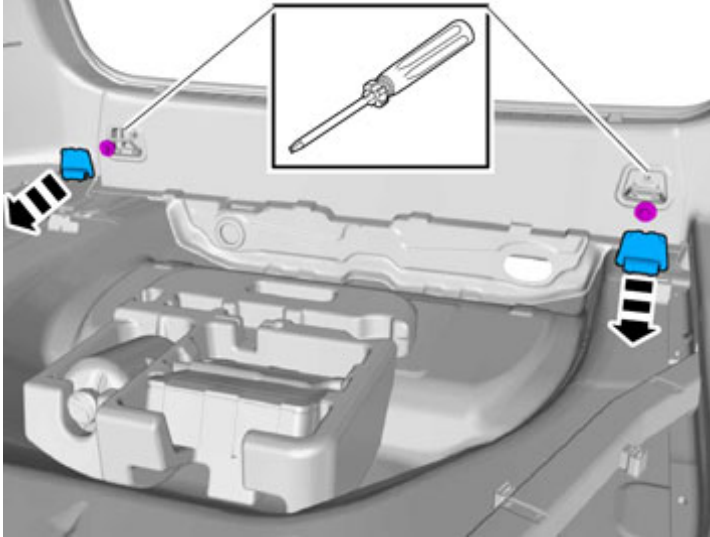

IMG-340028

Kampea suojuukset varovasti irti ja irrota ruuvit.

5

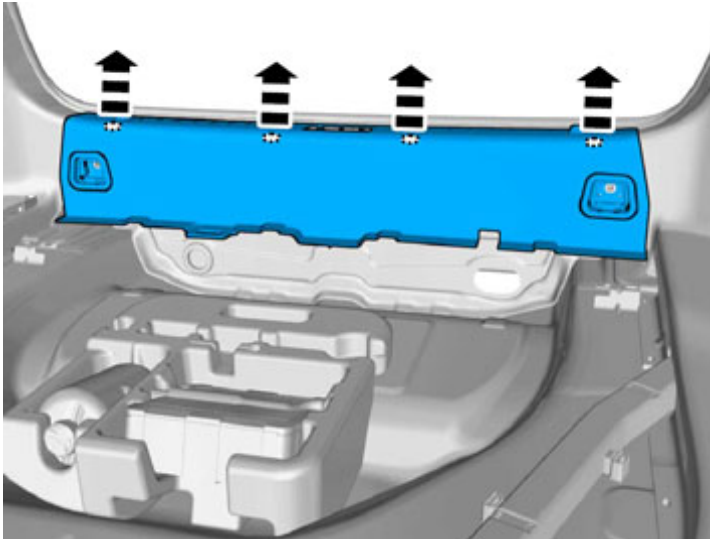

IMG-339896

Ota paneeli pois.



# Installation instructions, accessories

Volvo Car Corporation Gothenburg, Sweden

6

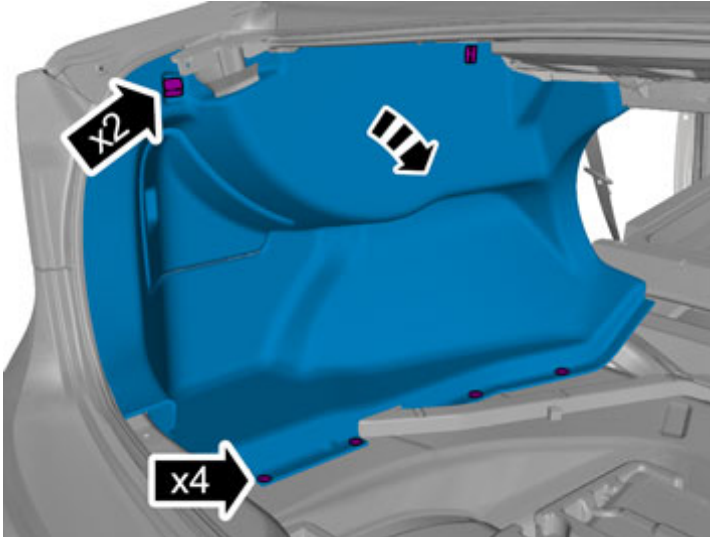

IMG-340029

7

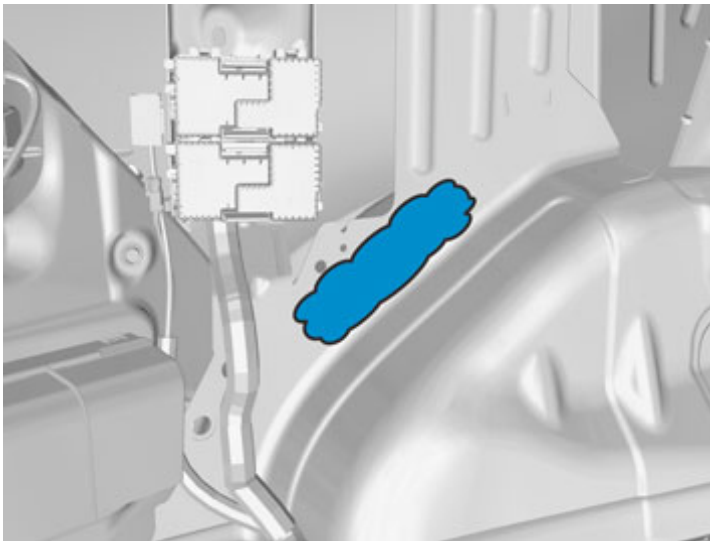

IMG-361427

Käytä: Isopropanoli, osanumero 1161721

Pyyhi kuivaksi.



# Installation instructions, accessories

Volvo Car Corporation Gothenburg, Sweden

8

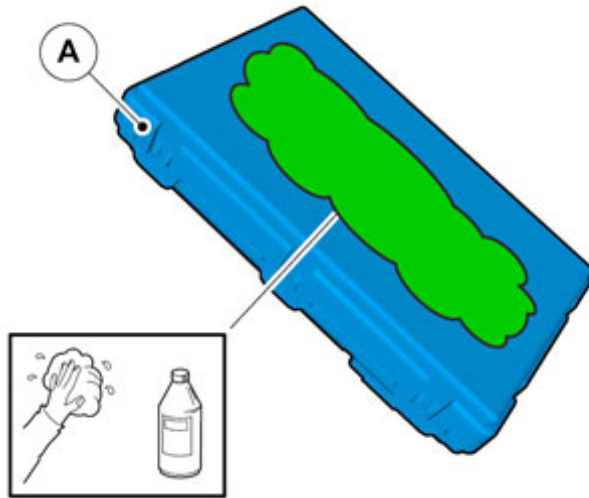

IMG-360218

Käytä: Isopropanoli, osanumero 1161721

Pyyhi kuivaksi.

9

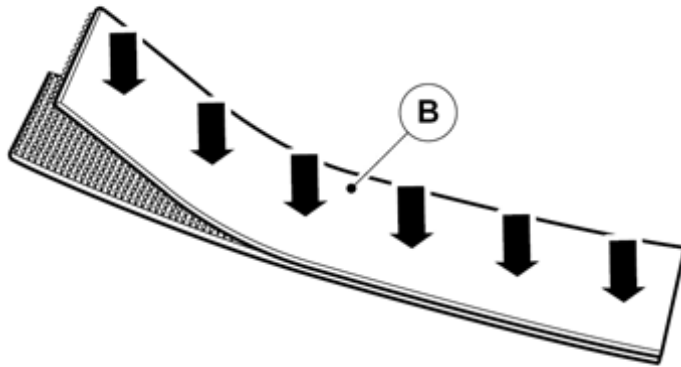

IMG-356181

Ota kaksi tarranauhaa sarjasta ja paina ne yhteen reuna reunaan vasten.



# Installation instructions, accessories

Volvo Car Corporation Gothenburg, Sweden

10

Irrota suojateippi tarranauhojen toiselta puolelta.

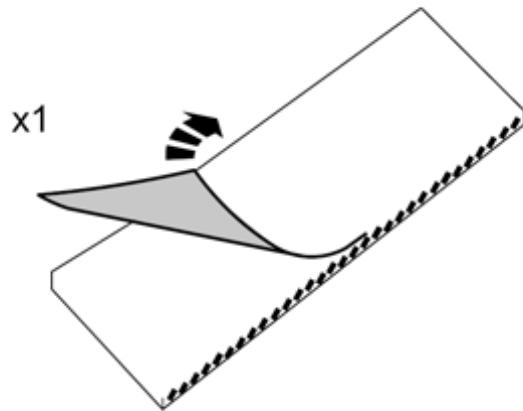

IMG-360227

11

Tarranauhaa asennettaessa on alustan lämpötilan oltava vähintään +20° C (68°F).

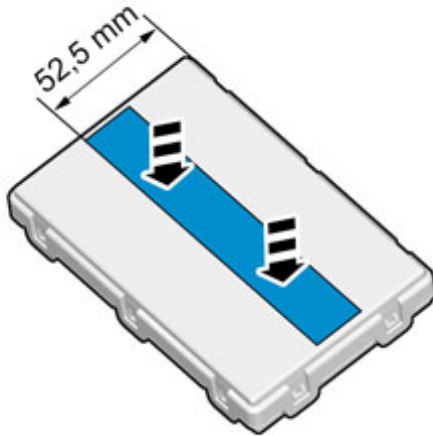

IMG-360231





# Installation instructions, accessories

Volvo Car Corporation Gothenburg, Sweden

12

Irrota suojateippi.

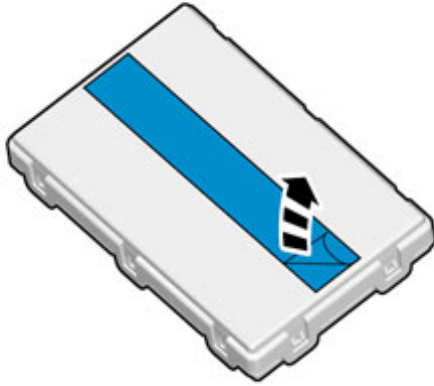

IMG-360236

13

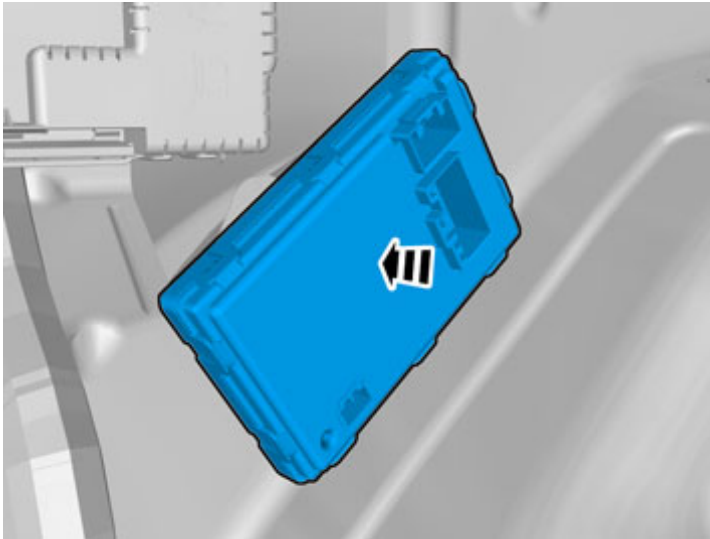

IMG-361429

Tarranauhaa asennettaessa on alustan lämpötilan oltava vähintään +20° C (68°F).

Paina ohjausyksikkö kunnolla kiinni.



# Installation instructions, accessories

Volvo Car Corporation Gothenburg, Sweden

14

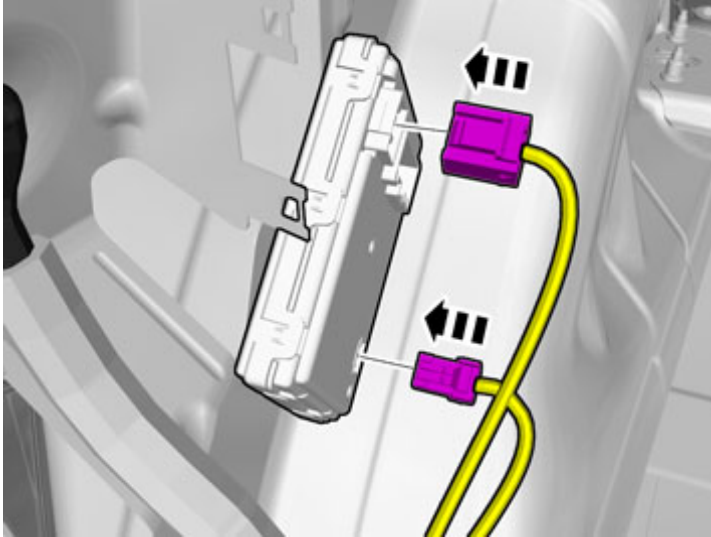

IMG-361430

Kytke esivedetyt liittimet ohjausyksikköön.  
On takimmaisena varokkeenpitimen liitännässä.

15

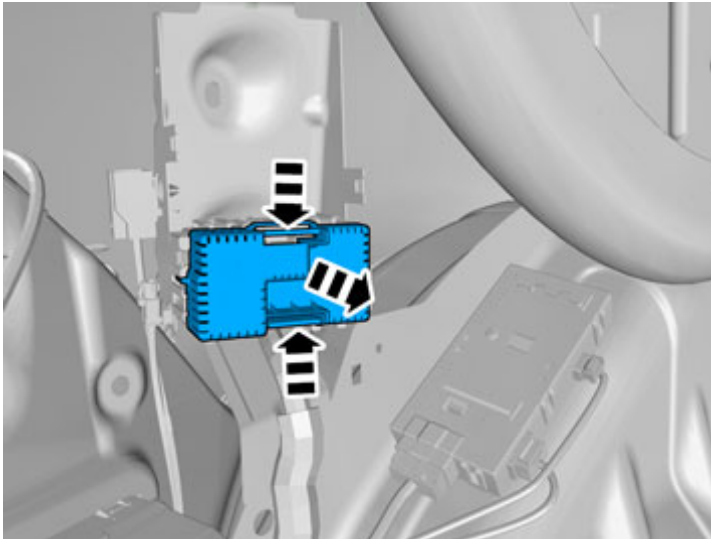

IMG-340109

Irrota kansi.



# Installation instructions, accessories

Volvo Car Corporation Gothenburg, Sweden

16

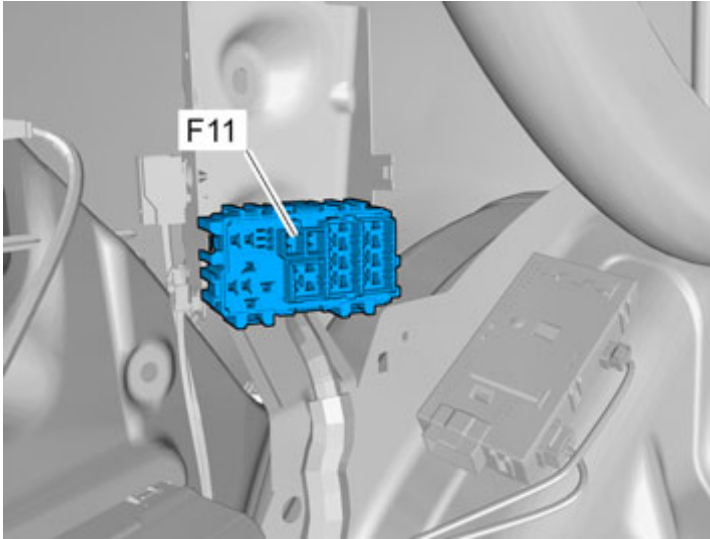

IMG-340105

Asenna 40 A varoke paikkaan FA11.

17

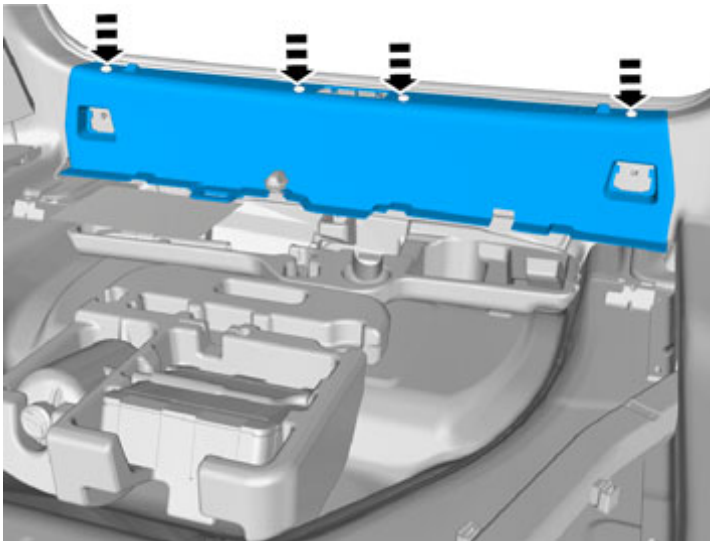

IMG-340201



# Installation instructions, accessories

Volvo Car Corporation Gothenburg, Sweden

18

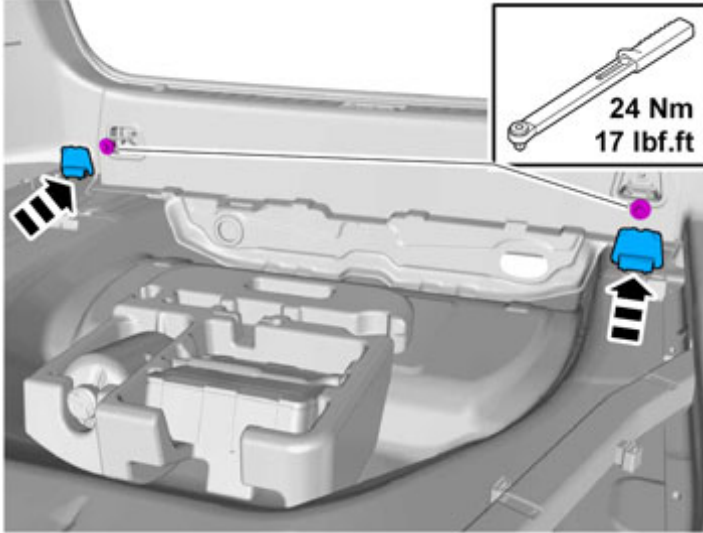

IMG-339899

19

Laita irrotetut osat takaisin päinvastaisessa järjestyksessä.

20

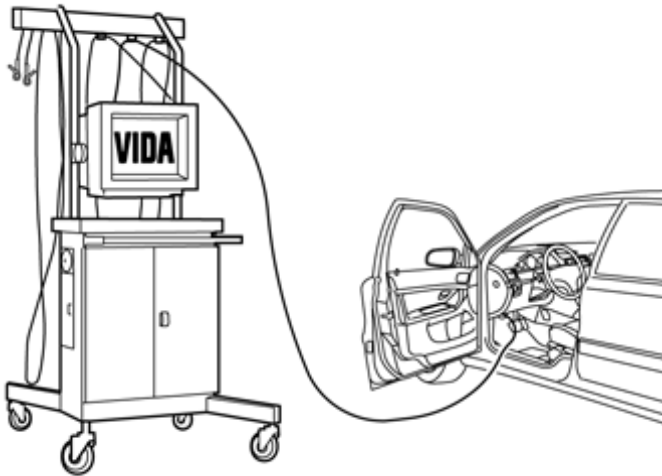

IMG-242268

Lataa ohjelmisto lisävarusteen toimintaa varten VIDAn huoltotietojen mukaan.

Katso VIDAsta tai lisävarusteluettelosta ohjelmiston osanumero.



# Installation instructions, accessories

Volvo Car Corporation Gothenburg, Sweden

21

Malli V60

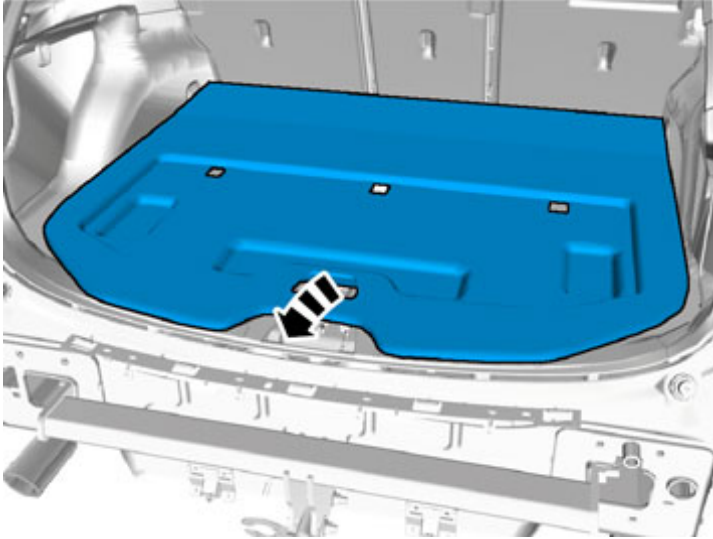

IMG-342225

22

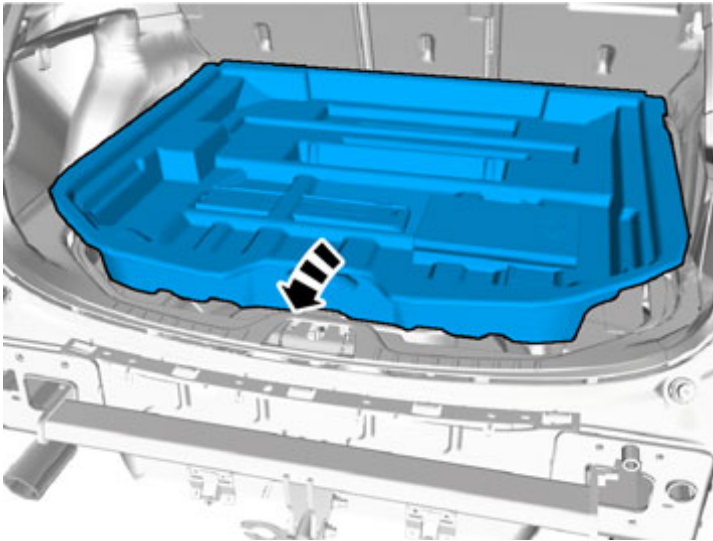

IMG-342227



# Installation instructions, accessories

Volvo Car Corporation Gothenburg, Sweden

23

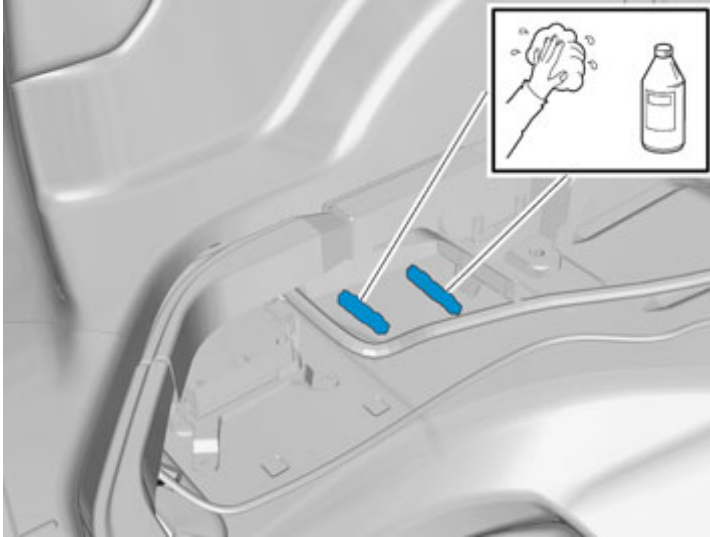

IMG-361456

Käytä: Isopropanoli, osanumero 1161721

Pyyhi kuivaksi.

24

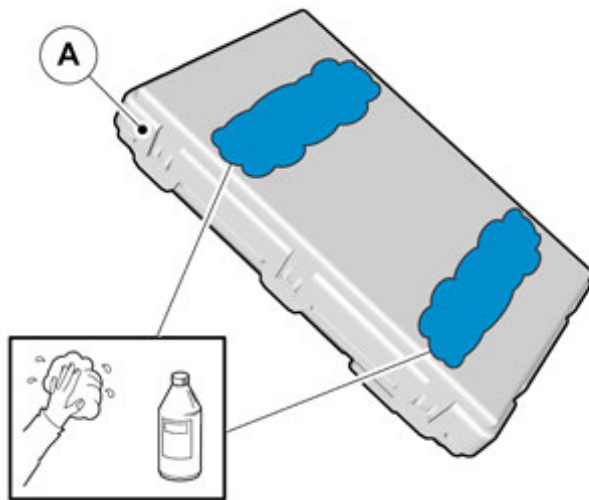

IMG-356179

Käytä: Isopropanoli, osanumero 1161721

Pyyhi kuivaksi.



# Installation instructions, accessories

Volvo Car Corporation Gothenburg, Sweden

25

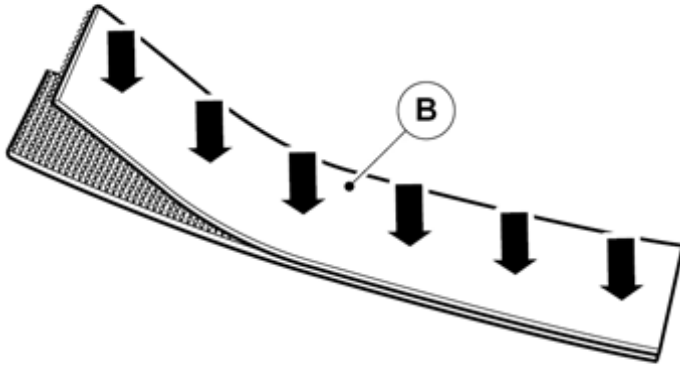

IMG-356181

26

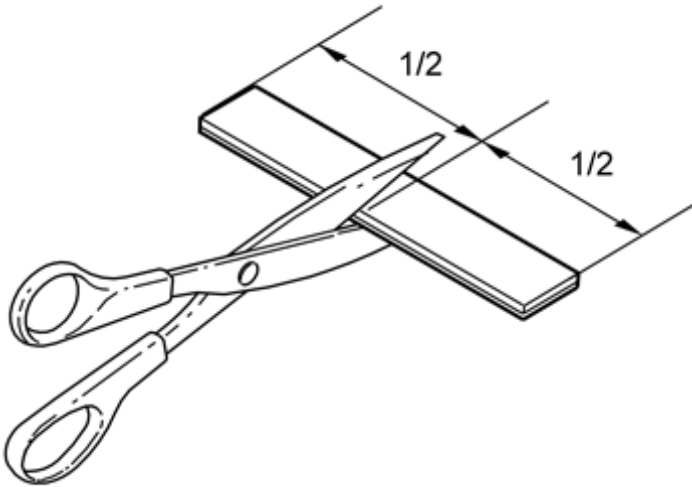

IMG-222282



# Installation instructions, accessories

Volvo Car Corporation Gothenburg, Sweden

27

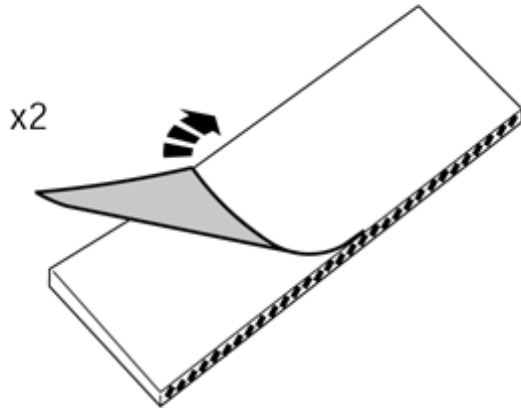

IMG-241925

28

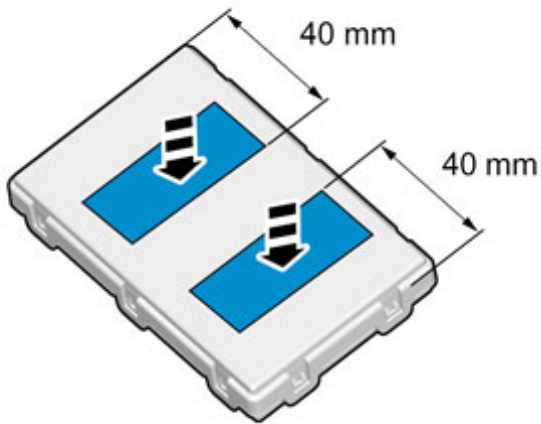

Tarranauhaa asennettaessa on alustan lämpötilan oltava vähintään +20° C (68° F).

IMG-356351





# Installation instructions, accessories

Volvo Car Corporation Gothenburg, Sweden

29

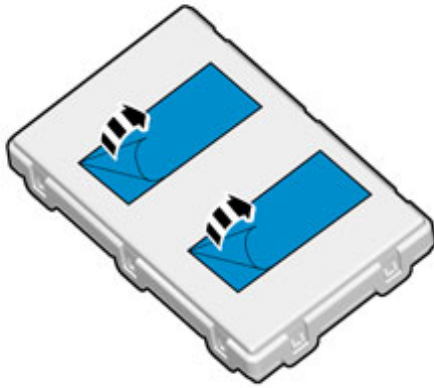

IMG-356352

30

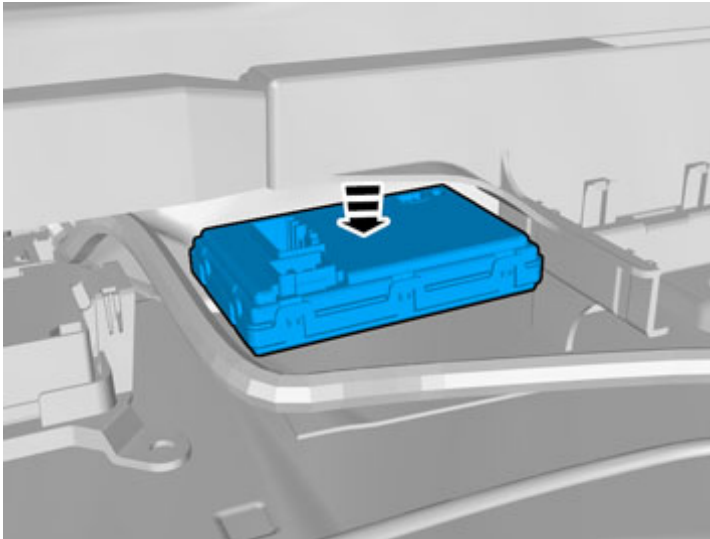

IMG-361461

Tarranauhaa asennettaessa on alustan lämpötilan oltava vähintään +20° C (68°F).

Paina ohjausyksikkö kiinni tavaratilan lattian puhdistettuun pintaan.



# Installation instructions, accessories

Volvo Car Corporation Gothenburg, Sweden

31

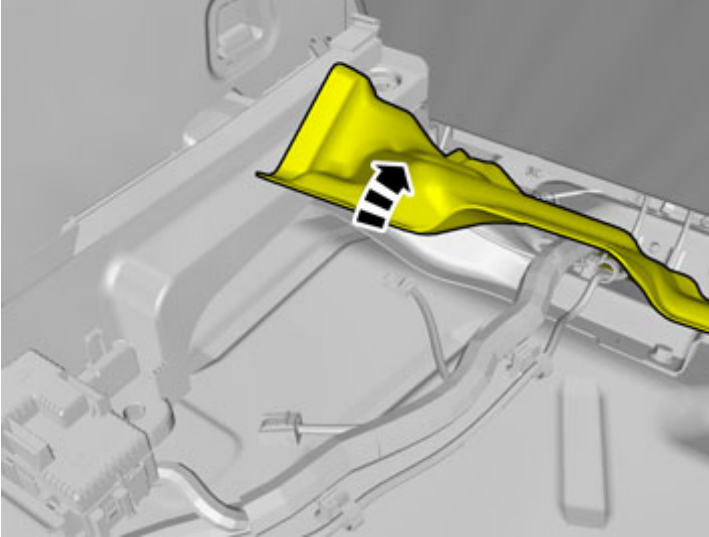

IMG-342289

**Autot vuosimallin -2012 loppuun**

Käännä ylös eristematto tavaratilan vasemmalla puolella etureunassa.

32

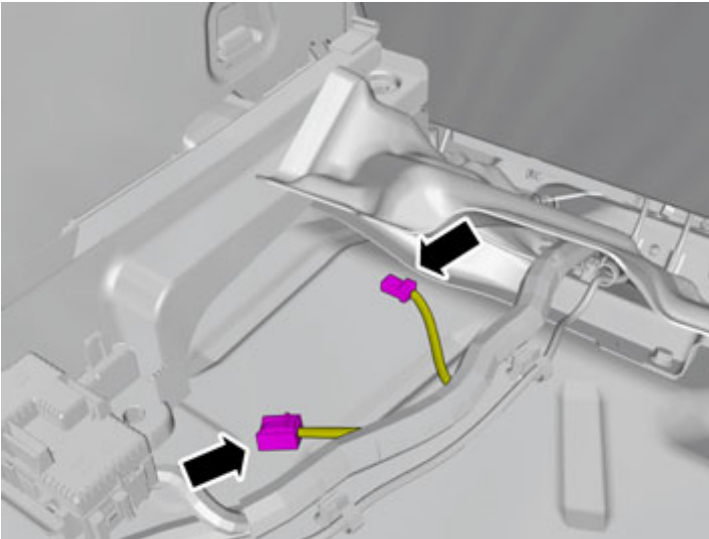

IMG-361448

Paikallista auton johdinkimppun liittimet.

33

Kytke jatkojohtosarja äsken etsimääsi liittimeen.

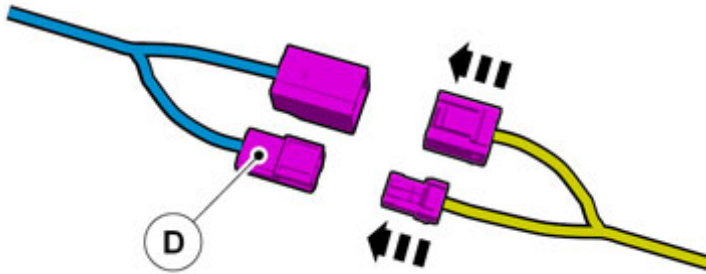

IMG-360183

34

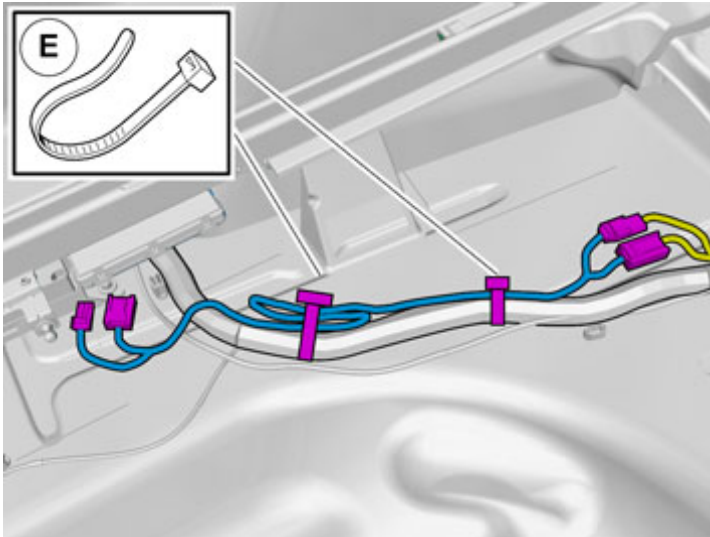

IMG-360336

Vedä jatkojohtosarja olemassa olevaa johdinkimppua pitkin.

Kiinnitä mahdollinen ylimääräinen pituus nippusiteillä.



# Installation instructions, accessories

Volvo Car Corporation Gothenburg, Sweden

35

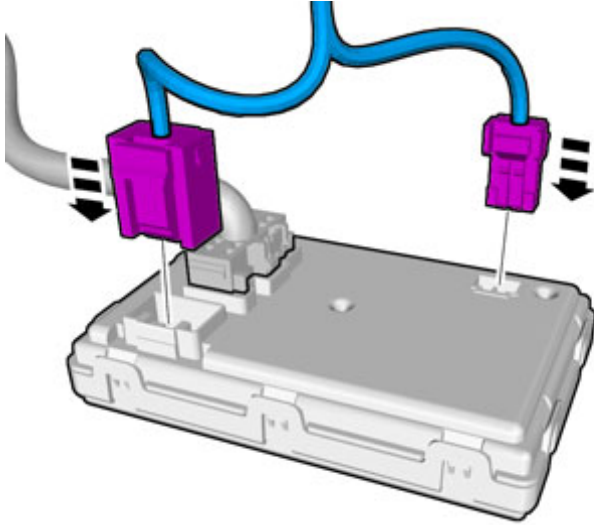

IMG-361449

Kytke jatkojohtosarjan liittimet ohjausyksikköön.

36

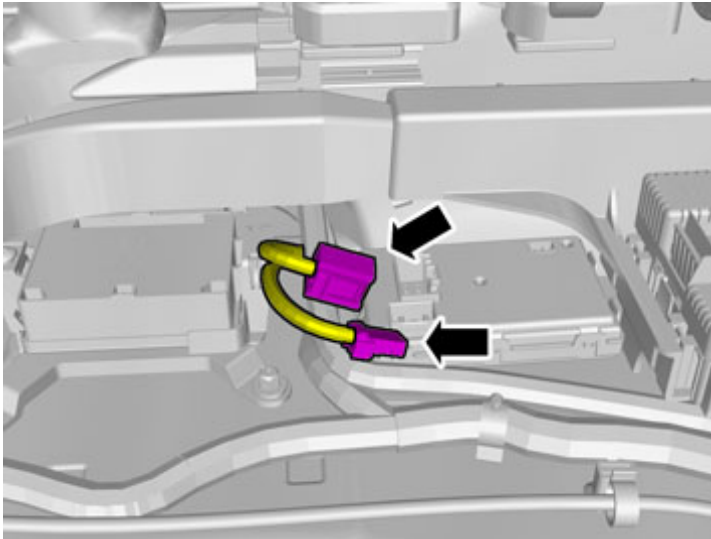

IMG-361481

**Autot alkaen vuosimallista 2013-**

Paikallista auton johdinkimppun liittimet.



# Installation instructions, accessories

Volvo Car Corporation Gothenburg, Sweden

37

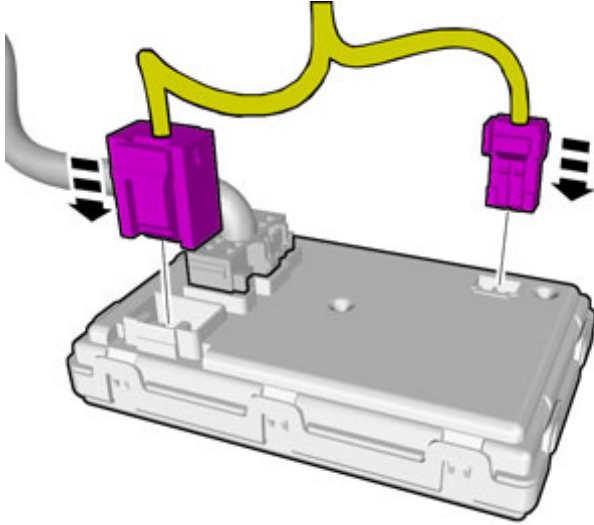

Kytke liitinkappaleet ohjausyksikköön.

IMG-361483

38

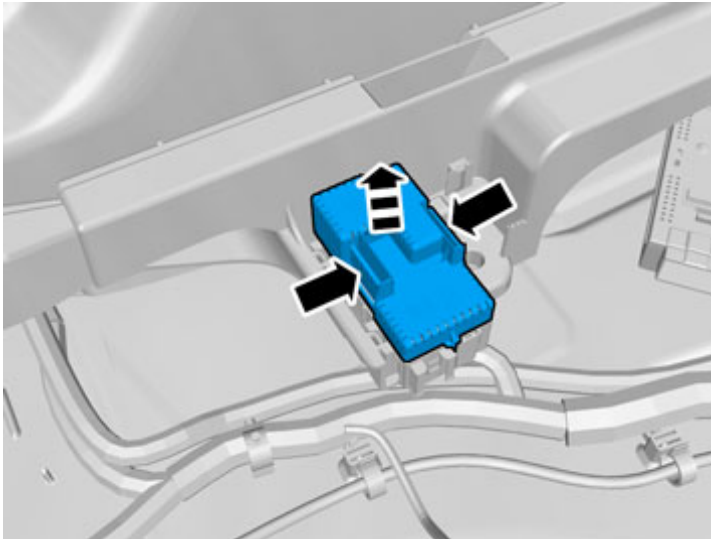

**Kaikki mallit**

Irrota musta varokkeenpitimen kansi

IMG-342291



# Installation instructions, accessories

Volvo Car Corporation Gothenburg, Sweden

39

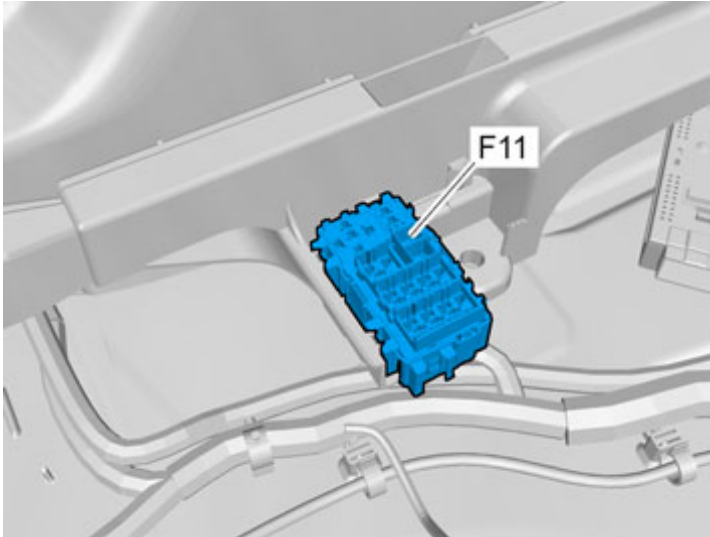

IMG-342292

Asenna 40 A varoke paikkaan FA11.

40

Laita irrotetut osat takaisin päinvastaisessa järjestyksessä.

41

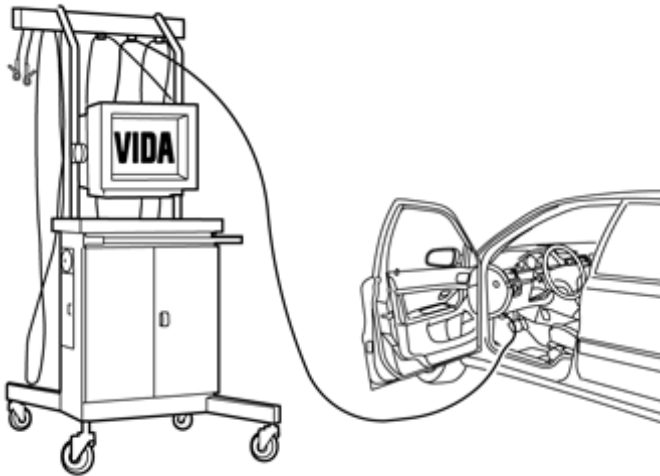

IMG-242268

Lataa ohjelmisto lisävarusteen toimintaa varten VIDAn huoltotietojen mukaan.

Katso VIDAsta tai lisävarusteluettelosta ohjelmiston osanumero.