

# Installation instructions, accessories

Volvo Car Corporation Gothenburg, Sweden

**Instruction No**  
31359353

**Version**  
1.1

**Part. No.**  
31373766, 31373456, 31359368, 31373458, 31373455, 31359366

## Bumper bar, front bumper

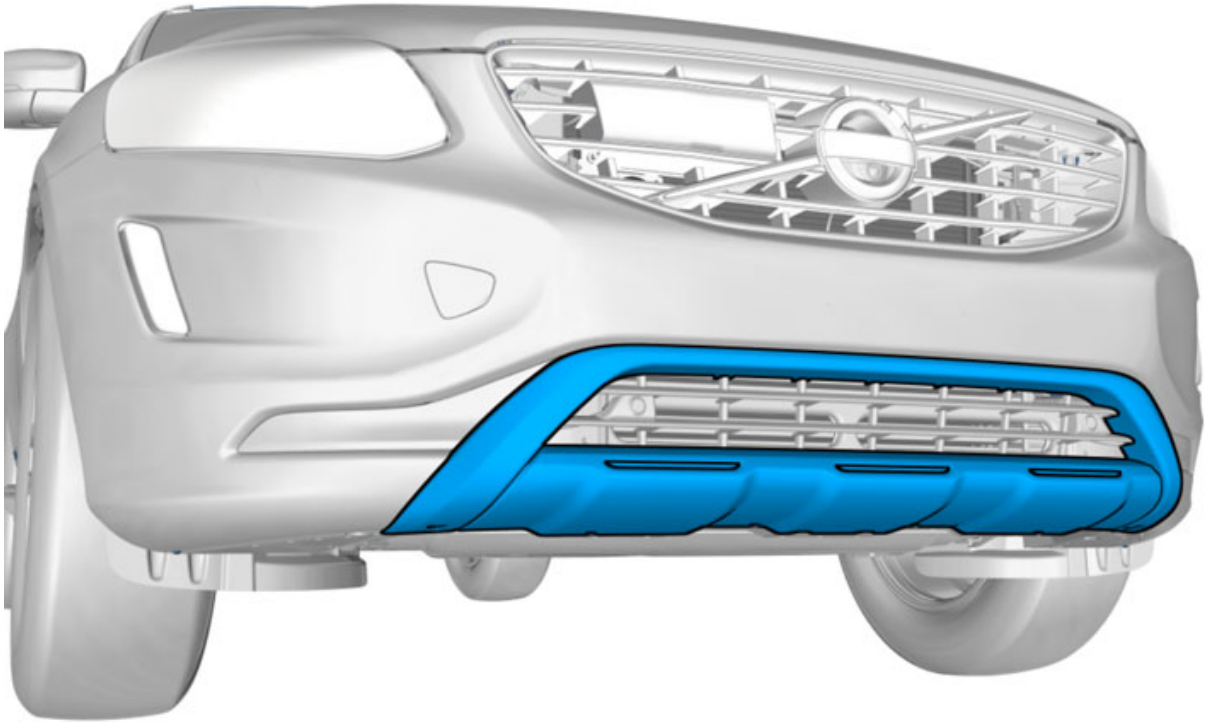

IMG-375145

### Materials

Designation	Part number
Isopropanol	1161721

### Equipment

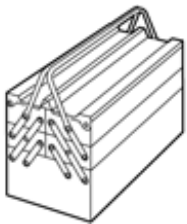

IMG-345497



IMG-239660

# Installation instructions, accessories

Volvo Car Corporation Gothenburg, Sweden

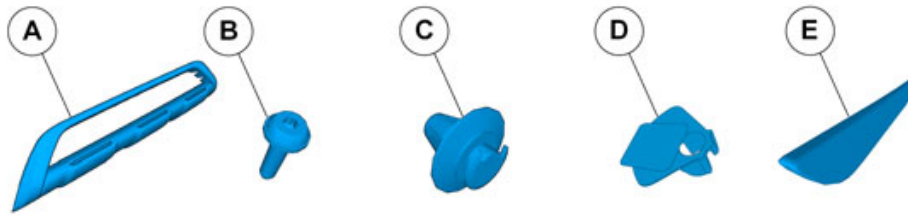

IMG-375166

# Installation instructions, accessories

Volvo Car Corporation Gothenburg, Sweden

---

## Information

---

1

Read through all of the instructions before starting installation.

Notifications and warning texts are for your safety and to minimise the risk of something breaking during installation.

Ensure that all tools stated in the instructions are available before starting installation.

Certain steps in the instructions are only presented in the form of images. Explanatory text is also given for more complicated steps.

In the event of any problems with the instructions or the accessory, contact your local Volvo dealer.

---

## Further information

---

2

When installing, the car must retain a temperature of 20 degrees C.

---

## Color symbols

---

3

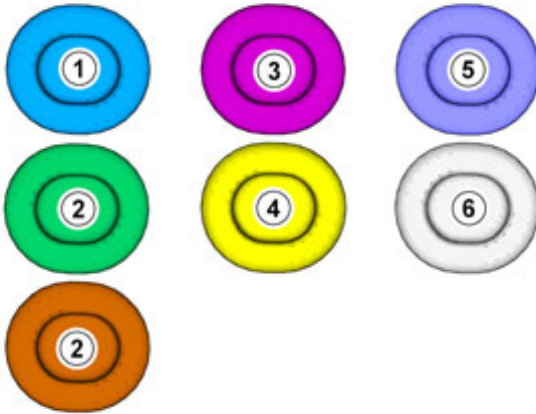

IMG-363036

### Note!

This colour chart displays (in colour print and electronic version) the importance of the different colours used in the images of the method steps.

1. Used for focused component, the component with which you will do something.
  2. Used as extra colors when you need to show or differentiate additional parts.
  3. Used for attachments that are to be removed/installed. May be screws, clips, connectors, etc.
  4. Used when the component is not fully removed from the vehicle but only hung to the side.
  5. Used for standard tools and special tools.
  6. Used when the component is not fully removed from the vehicle but only hung to the side.
- 

## Applies to unpainted component

---

# Installation instructions, accessories

Volvo Car Corporation Gothenburg, Sweden

4

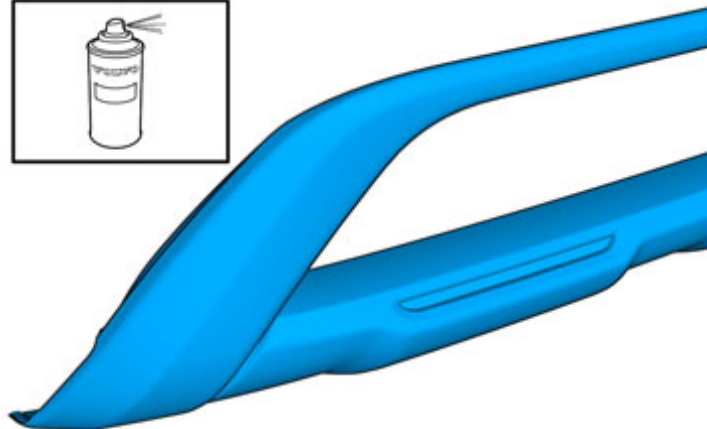

IMG-377449

5

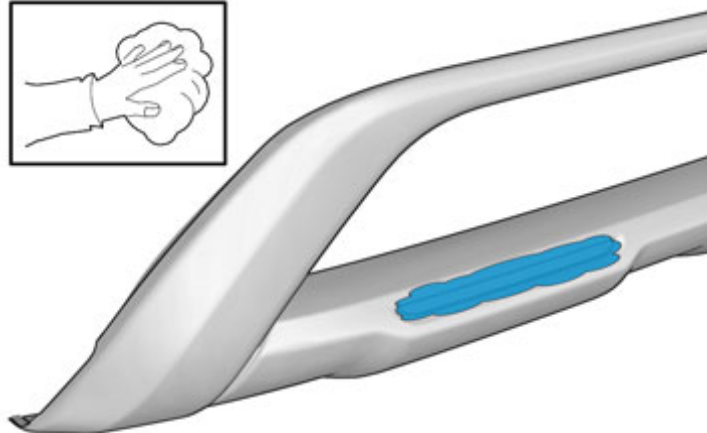
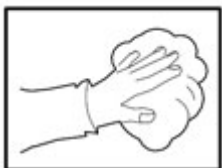

IMG-377450

**Caution!**

First the paint must dry after painting.

Clean the surface.

**Use:** 1161721, Isopropanol

# Installation instructions, accessories

Volvo Car Corporation Gothenburg, Sweden

6

Remove the protective film.

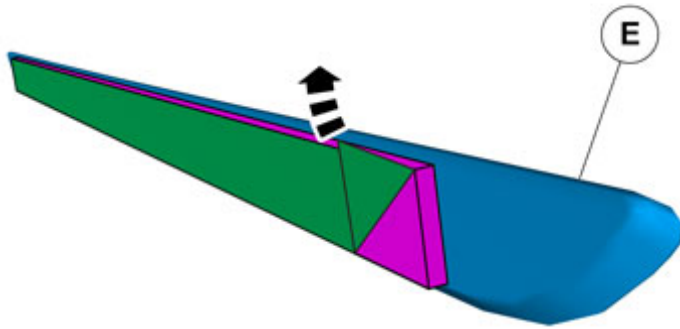

**x3**

IMG-377453

7

Install component that comes with the accessory kit.

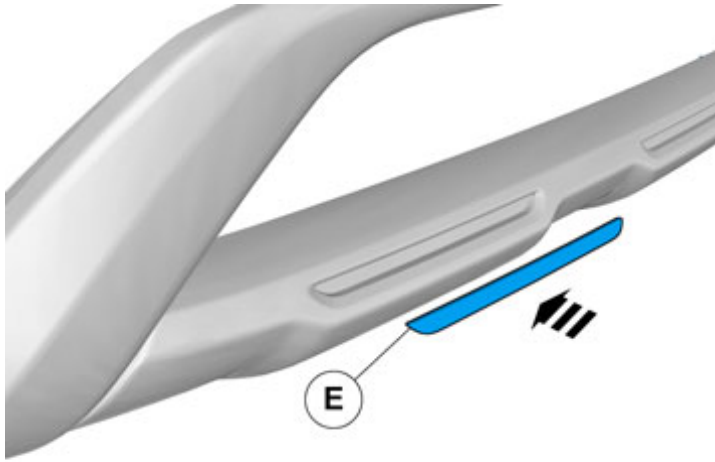

IMG-377451

**All vehicles**

**Removal**

# Installation instructions, accessories

Volvo Car Corporation Gothenburg, Sweden

8

Remove the screws.

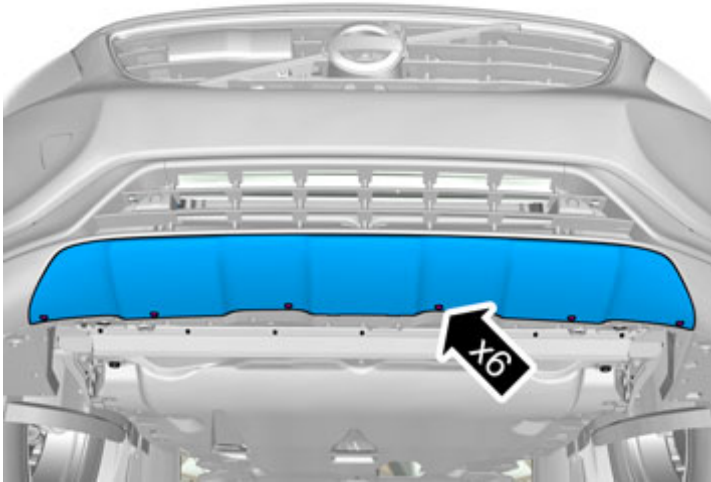

IMG-375159

9

Remove the panel.

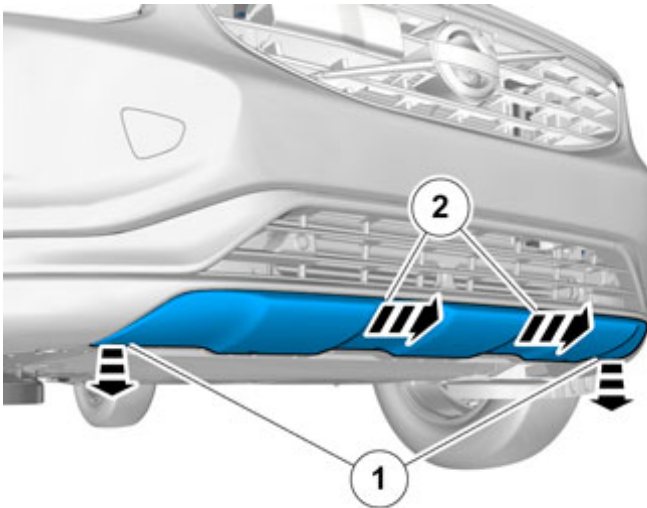

IMG-375160

**Accessory installation**

# Installation instructions, accessories

Volvo Car Corporation Gothenburg, Sweden

10

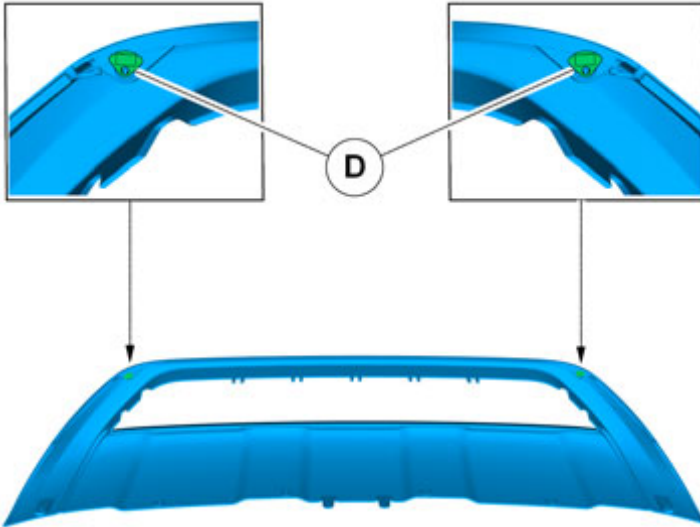

IMG-375199

11

Remove the protective film.

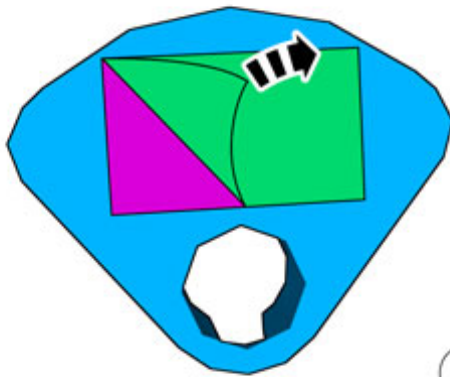

(D) x2

IMG-375204

# Installation instructions, accessories

Volvo Car Corporation Gothenburg, Sweden

12

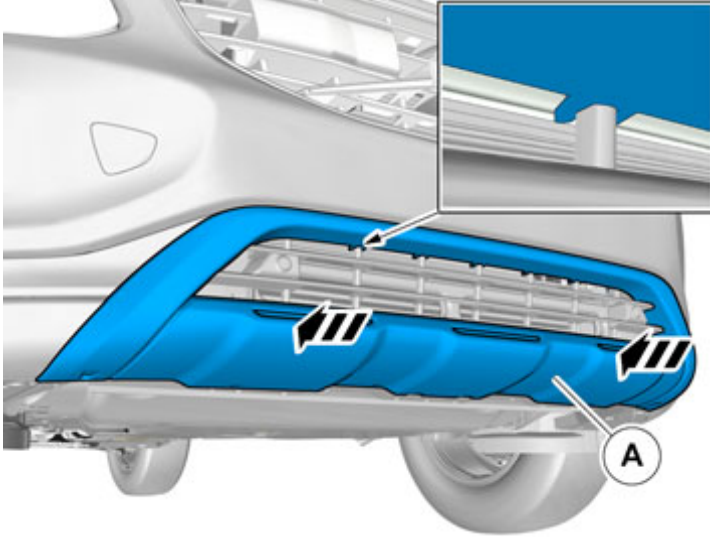

IMG-375162

13

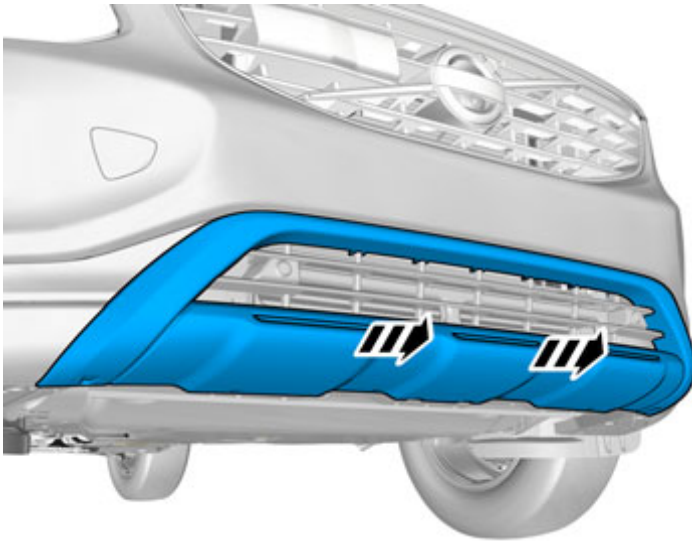

IMG-375206



# Installation instructions, accessories

Volvo Car Corporation Gothenburg, Sweden

14

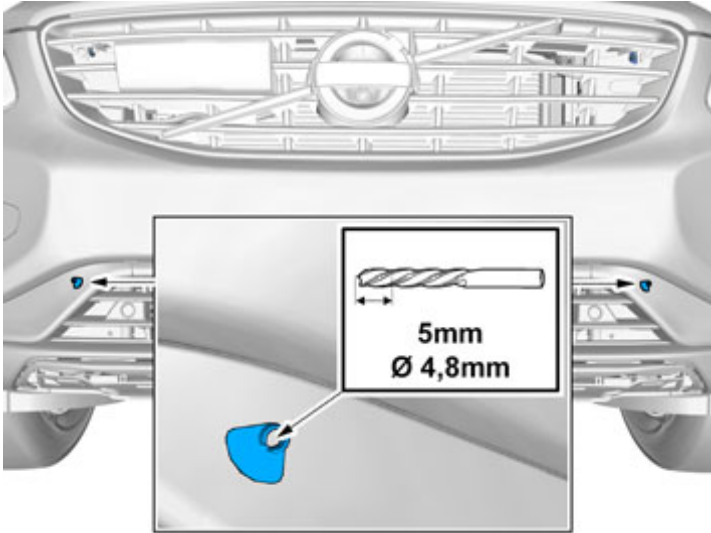

IMG-375205

15

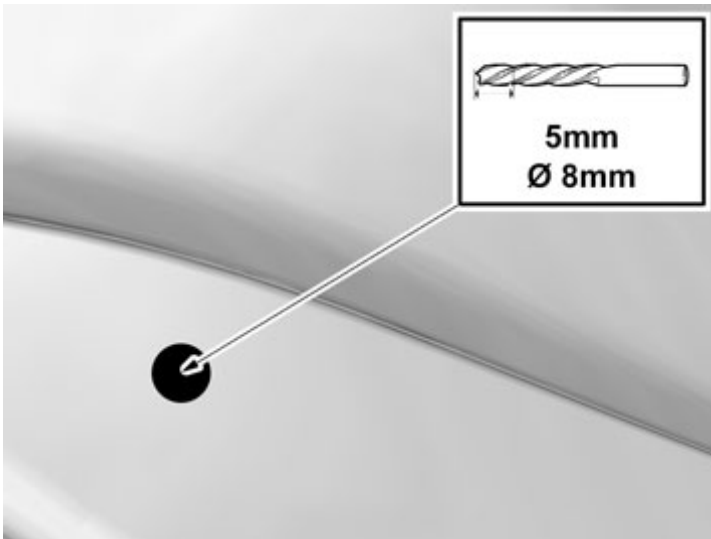

IMG-375208

Drill the holes.

# Installation instructions, accessories

Volvo Car Corporation Gothenburg, Sweden

16

Install the clips as illustrated.

Fold the protective film forward

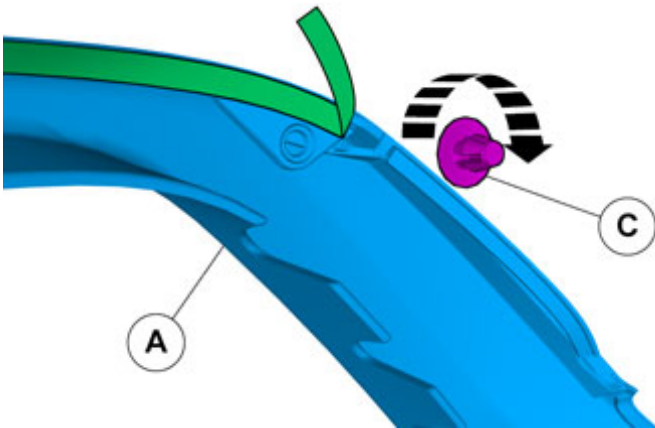

IMG-375224

17

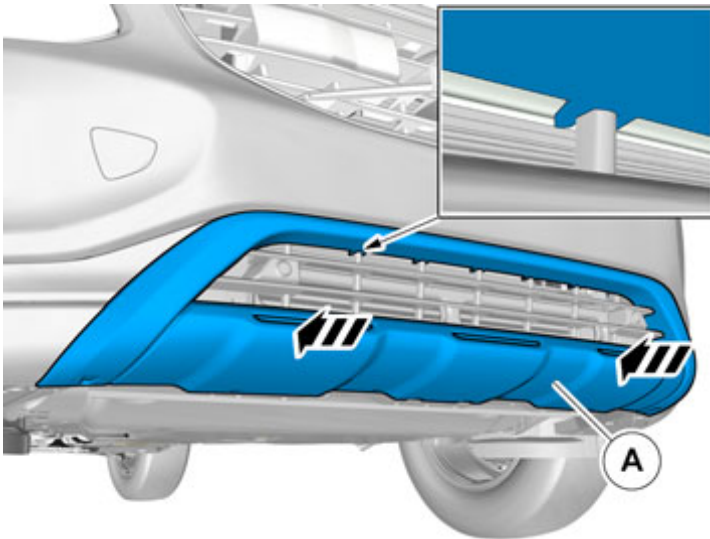

IMG-375162

# Installation instructions, accessories

Volvo Car Corporation Gothenburg, Sweden

18

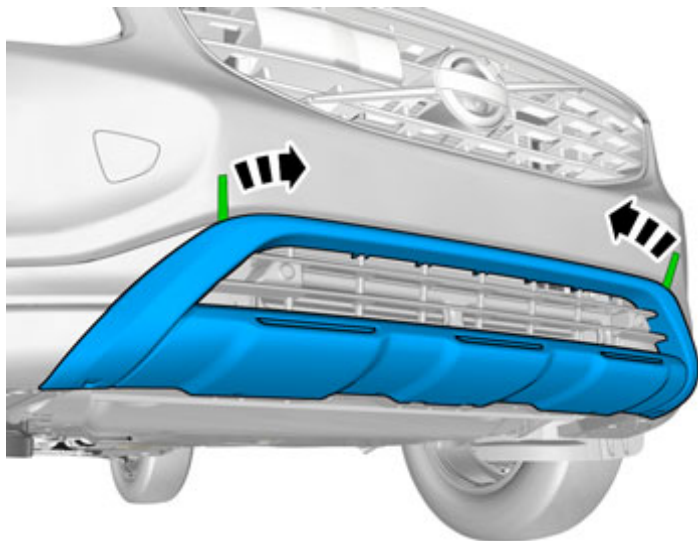

IMG-375528

## Hint

Press and apply pressure to the part over the tape for at least 20 seconds.

19

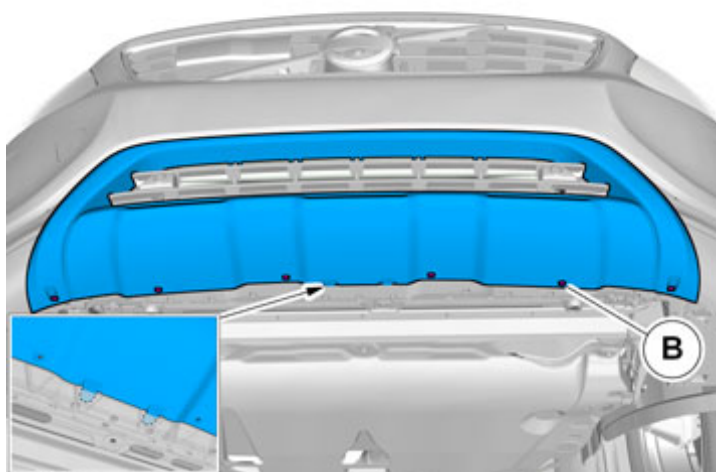

IMG-375164

Install the screws.

Note position of components.