

Installation instructions, accessories

Volvo Car Corporation Gothenburg, Sweden

Nº instrucciones	Versión	Nº pieza
31439014	1.0	31373978

Cortinilla solar, luneta trasera

Equipamiento



IMG-239667



IMG-397698

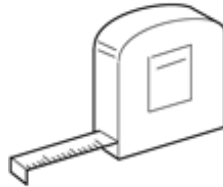

IMG-244945

A

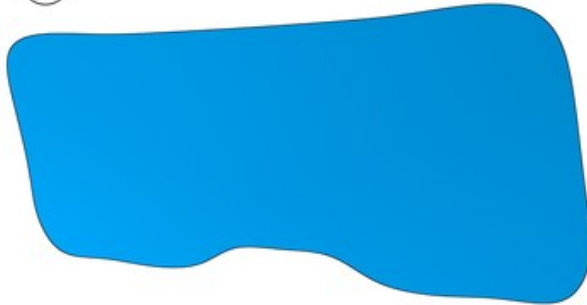

B

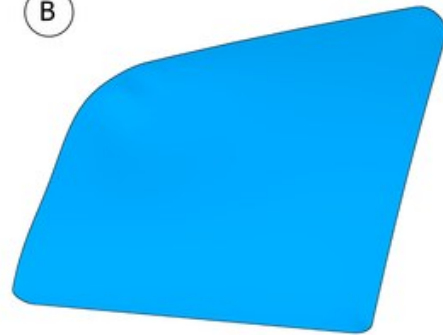

C

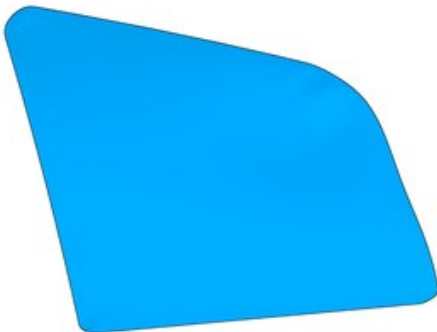

IMG-397786

D



x9

Installation instructions, accessories

Volvo Car Corporation Gothenburg, Sweden

Información

1

Leer las instrucciones completas antes de iniciar el montaje.

Las notas y los textos de advertencia son para seguridad personal y para minimizar el riesgo de dañar componentes al instalar.

Antes de iniciar el montaje, comprobar que se dispone de todas las herramientas indicadas en las instrucciones.

Algunos pasos de estas instrucciones se presentan solamente con ilustraciones. Para los pasos más complicados hay también texto explicativo.

En caso de haber problemas con las instrucciones o el accesorio, contactar con el concesionario Volvo local.

Montaje de accesorios

2



IMG-384915

3



IMG-397790

¡Atención!
Vista de orientación

Installation instructions, accessories

Volvo Car Corporation Gothenburg, Sweden

4



IMG-397690

Utilice cinta adhesiva

5

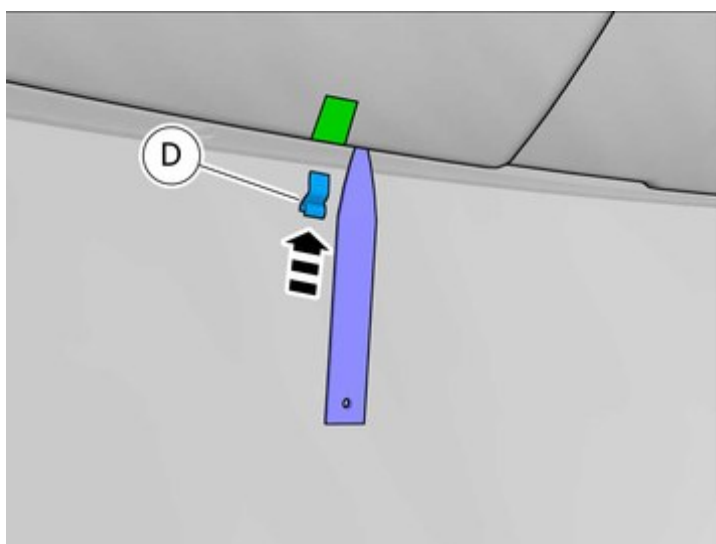

IMG-397685

Monte la pieza del kit de accesorios.

Usar: Plegadera

Installation instructions, accessories

Volvo Car Corporation Gothenburg, Sweden

6

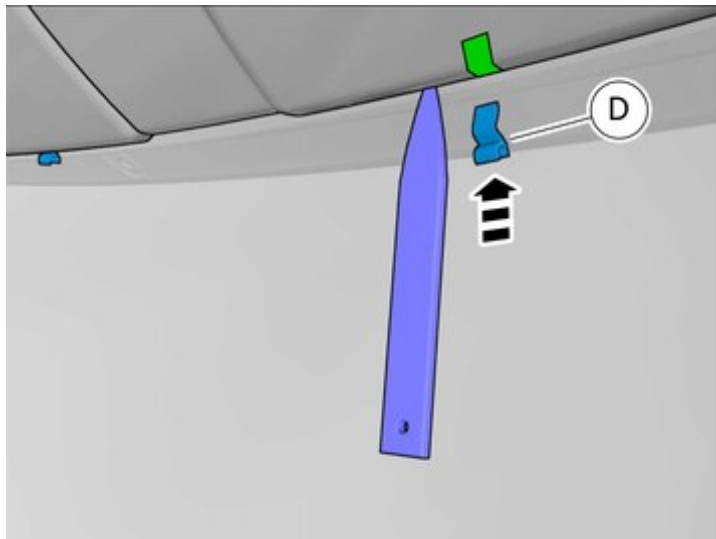

IMG-397686

Monte la pieza del kit de accesorios.

Usar: Plegadera

7

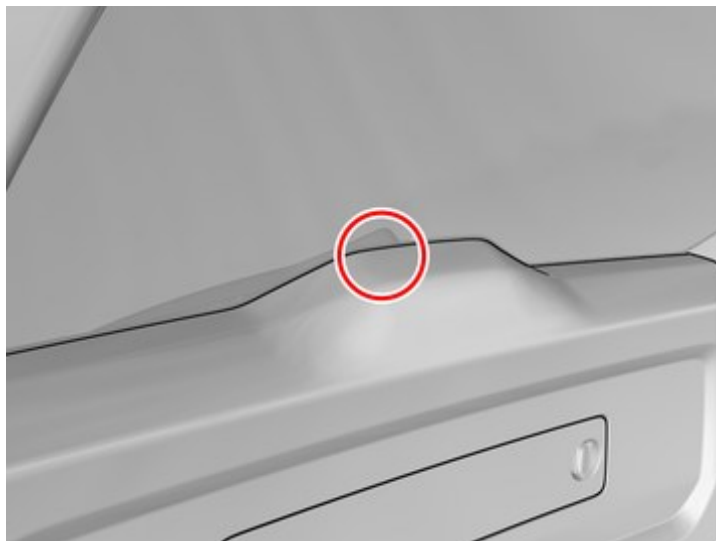

IMG-397701

Installation instructions, accessories

Volvo Car Corporation Gothenburg, Sweden

8

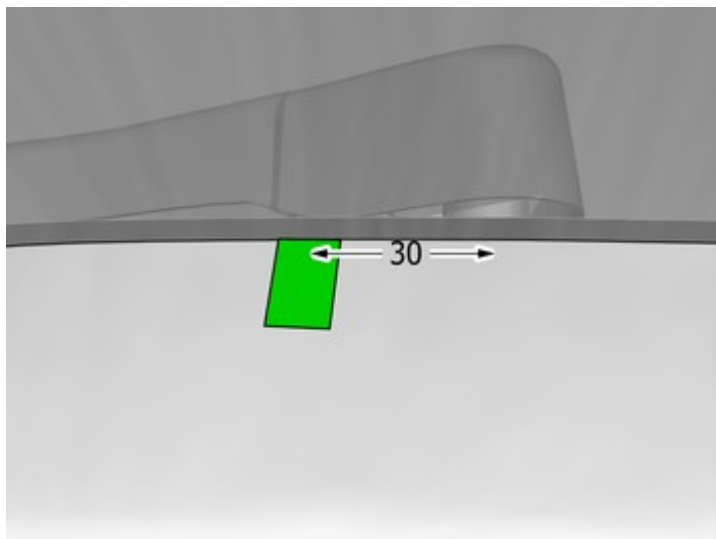

IMG-397700

Utilice cinta adhesiva

9

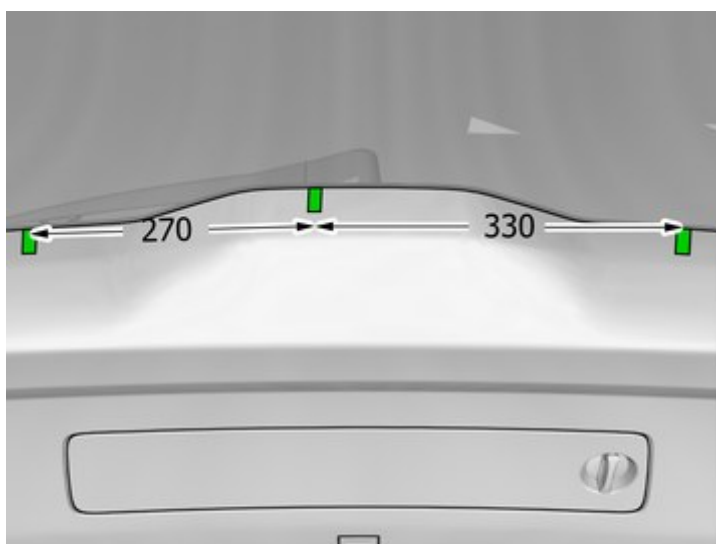

IMG-397703

Utilice cinta adhesiva

Installation instructions, accessories

Volvo Car Corporation Gothenburg, Sweden

10

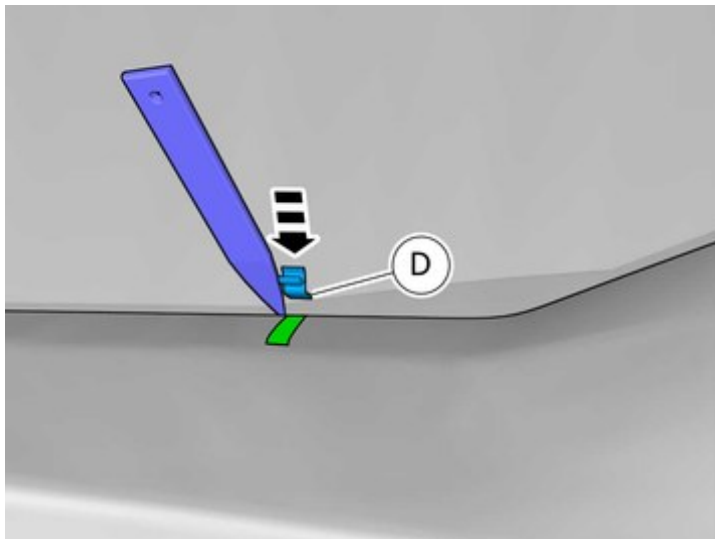

IMG-397706

Monte la pieza del kit de accesorios.

11

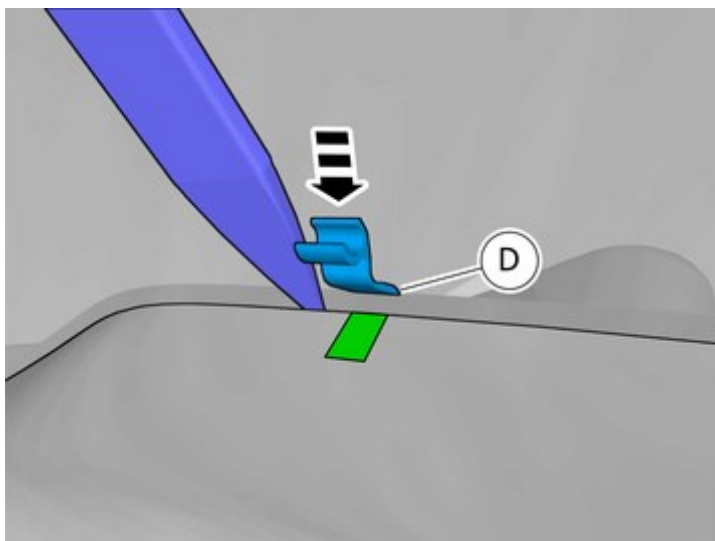

IMG-397707

Monte la pieza del kit de accesorios.

Installation instructions, accessories

Volvo Car Corporation Gothenburg, Sweden

12

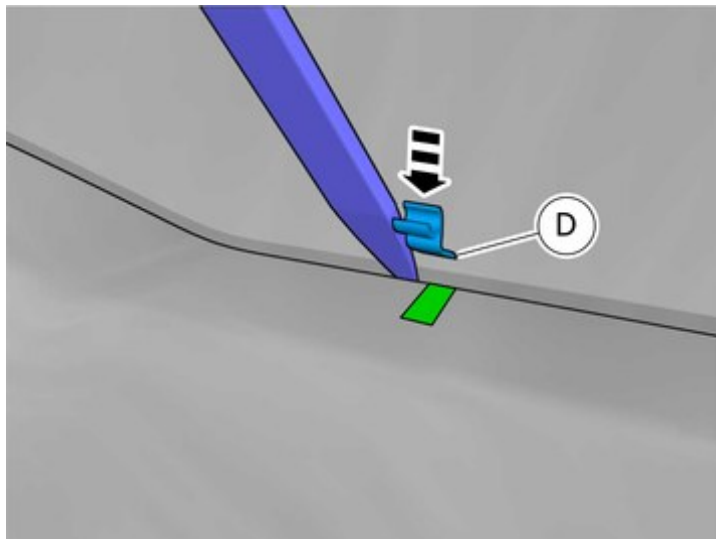

IMG-397708

Monte la pieza del kit de accesorios.

13

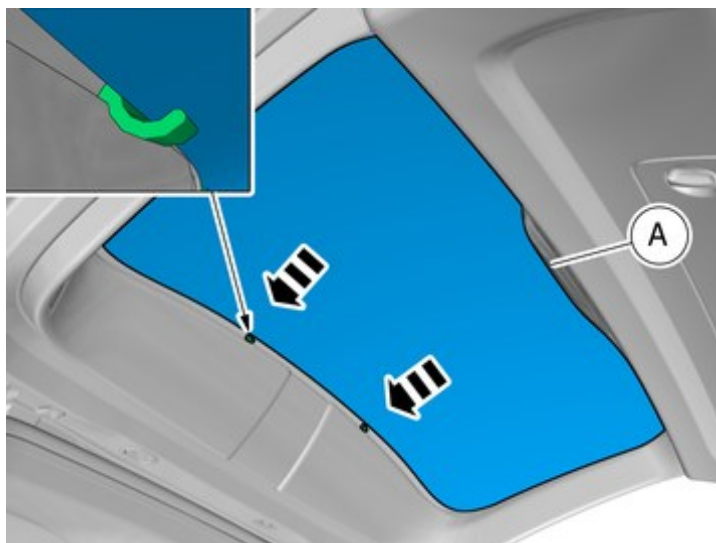

IMG-397733

Monte la pieza del kit de accesorios.

Installation instructions, accessories

Volvo Car Corporation Gothenburg, Sweden

14

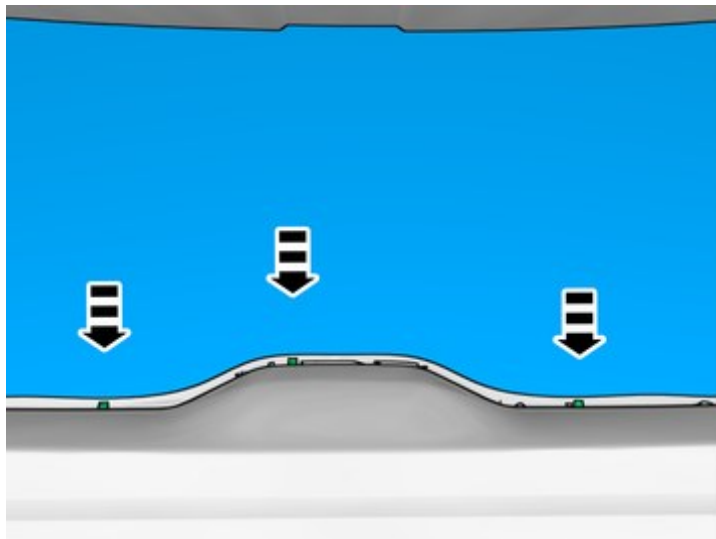

IMG-397732

Comprobar que todas las presillas agarran.

15



IMG-397766

¡Atención!
Vista de orientación

Installation instructions, accessories

Volvo Car Corporation Gothenburg, Sweden

16



IMG-397765

Utilice cinta adhesiva

17

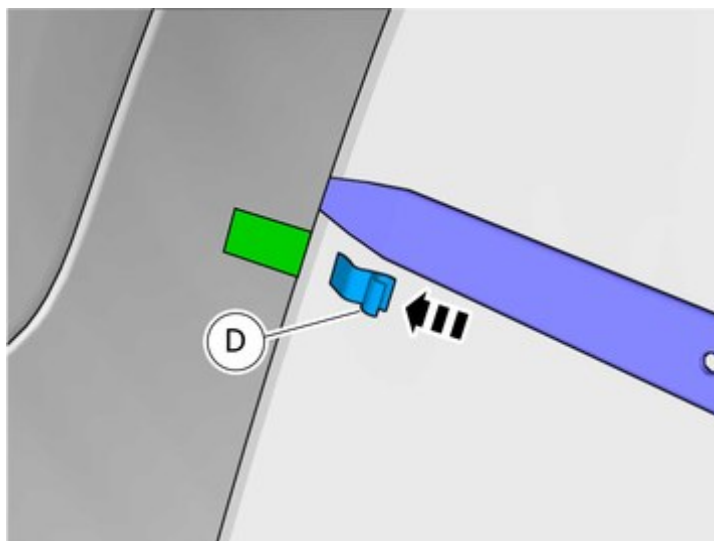

IMG-397768

Monte la pieza del kit de accesorios.

Installation instructions, accessories

Volvo Car Corporation Gothenburg, Sweden

18

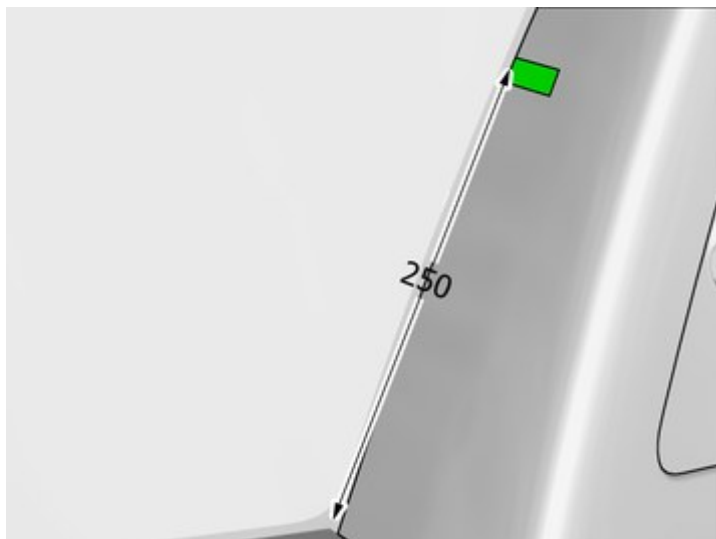

IMG-397771

Utilice cinta adhesiva

19

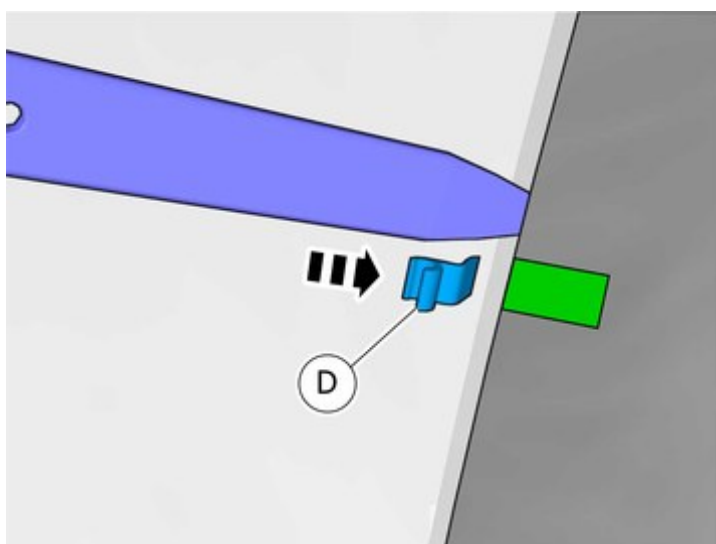

IMG-397772

Monte la pieza del kit de accesorios.

Installation instructions, accessories

Volvo Car Corporation Gothenburg, Sweden

20

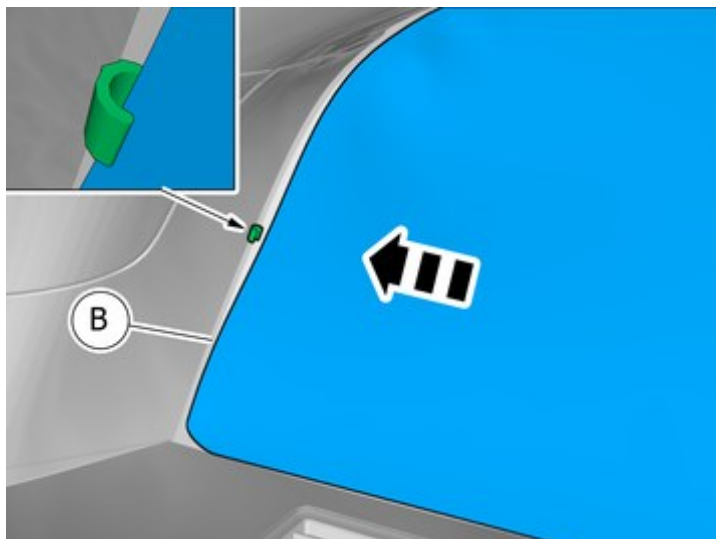

IMG-397780

Monte la pieza del kit de accesorios.

21

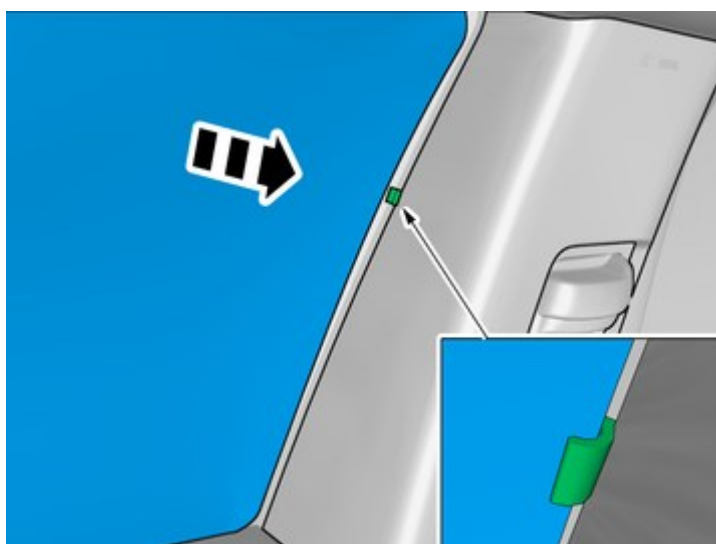

IMG-397783

22

Repita los pasos del método de montaje de accesorios en el lado opuesto.