



Installation instructions, accessories

Volvo Car Corporation Gothenburg, Sweden

Instruction No	Version	Part. No.
31346082	1.0	31407107, 31346554, 31350479

Towbar, control module TRM



Installation instructions, accessories

Volvo Car Corporation Gothenburg, Sweden

Equipment

VIDA

IMG-242205

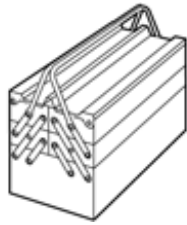

IMG-345497



IMG-332314

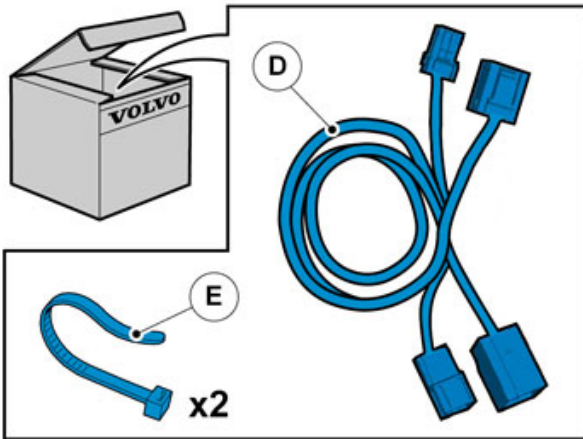
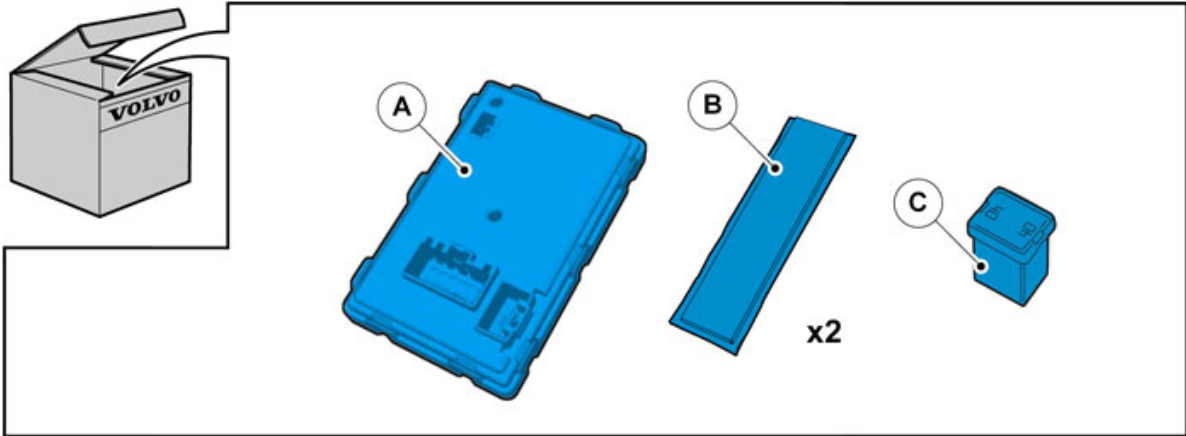

IMG-360181



Installation instructions, accessories

Volvo Car Corporation Gothenburg, Sweden

INTRODUCTION

Read through all of the instructions before starting installation.

Notifications and warning texts are for your safety and to minimise the risk of something breaking during installation.

Ensure that all tools stated in the instructions are available before starting installation.

Certain steps in the instructions are only presented in the form of images. Explanatory text is also given for more complicated steps.

In the event of any problems with the instructions or the accessory, contact your local Volvo dealer.

1



Turn the ignition key to position 0.

Note!

Wait at least one minute before unplugging the connectors or removing other electrical equipment.

IMG-245980

2

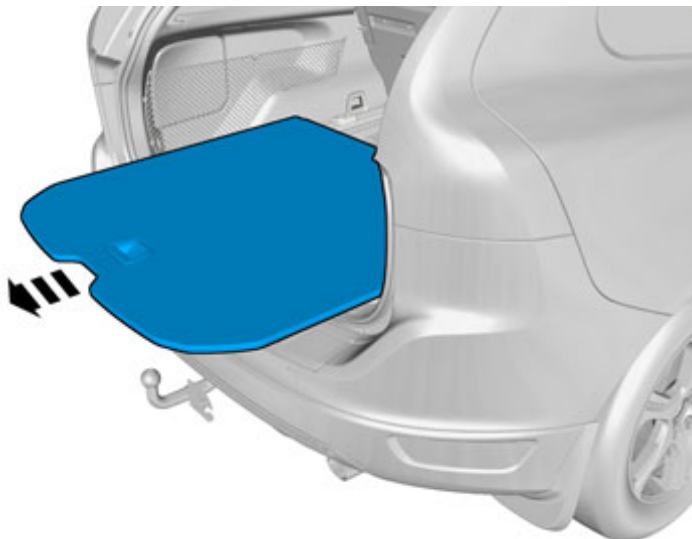

IMG-346921



Installation instructions, accessories

Volvo Car Corporation Gothenburg, Sweden

3



IMG-346811

4



IMG-360187



Installation instructions, accessories

Volvo Car Corporation Gothenburg, Sweden

5

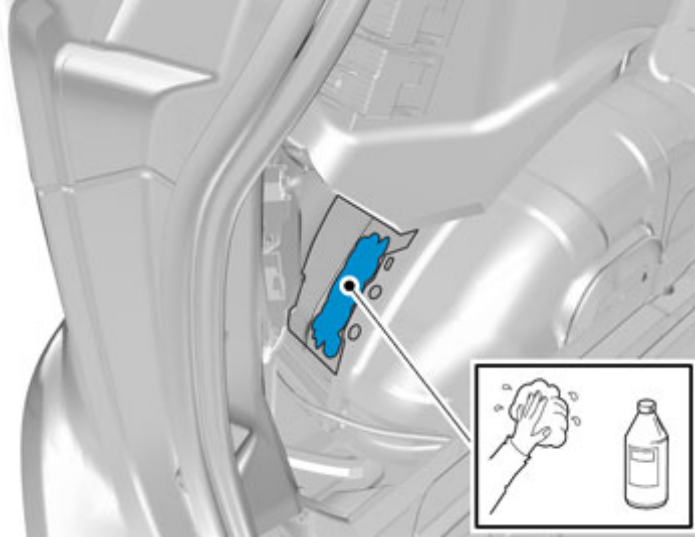

IMG-362267

Use: Isopropanol, P/N 116172

Wipe dry.

6

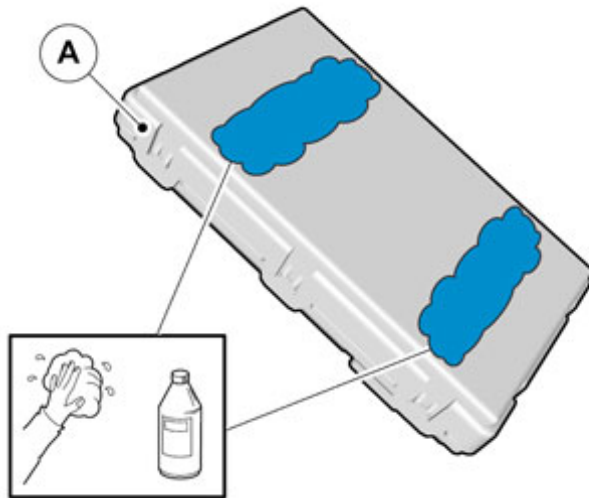

IMG-356179

Use: Isopropanol, P/N 1161721

Wipe dry.



Installation instructions, accessories

Volvo Car Corporation Gothenburg, Sweden

7

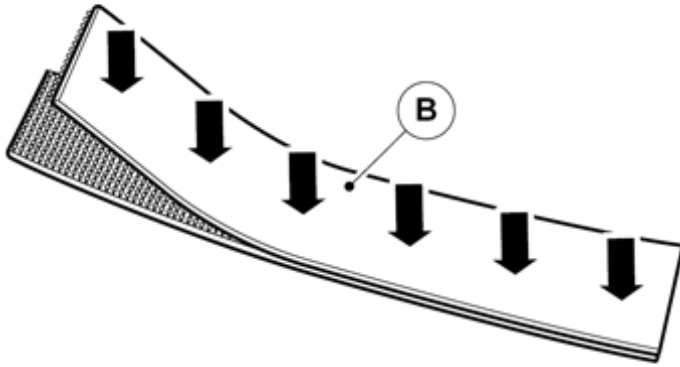

IMG-356181

8

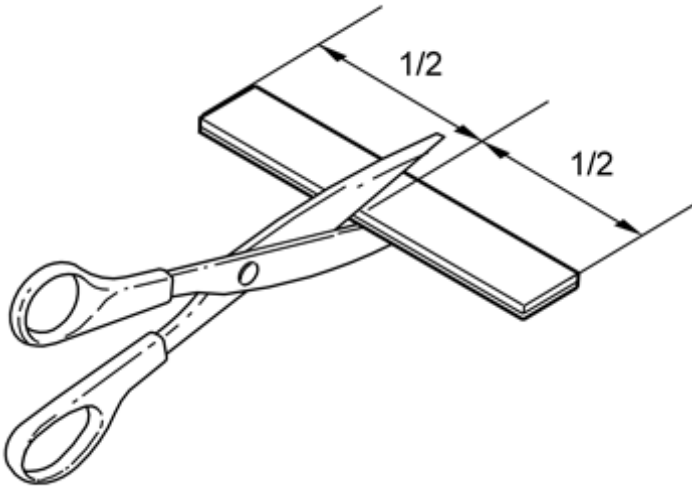

IMG-222282



Installation instructions, accessories

Volvo Car Corporation Gothenburg, Sweden

9

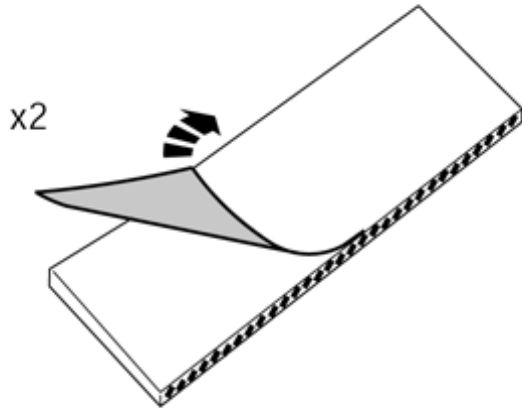

IMG-241925

10

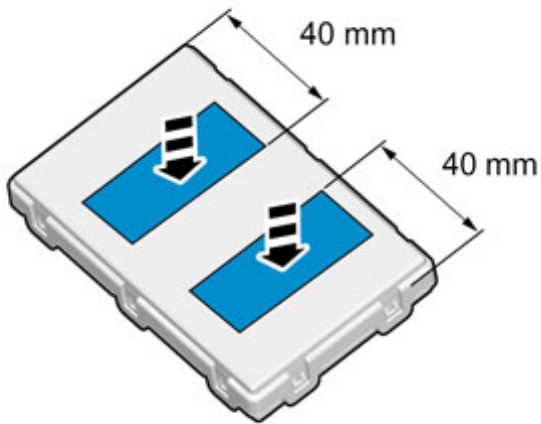

When installing Velcro tape the surface must maintain a temperature of at least +20 ° C (68°F).

IMG-356351



Installation instructions, accessories

Volvo Car Corporation Gothenburg, Sweden

11

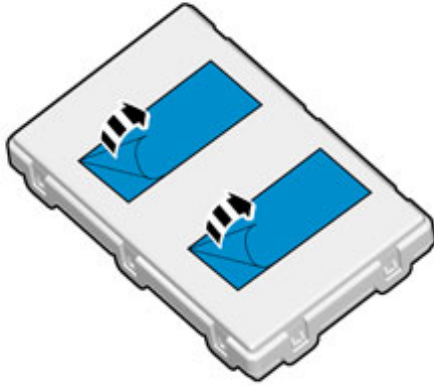

IMG-356352

12

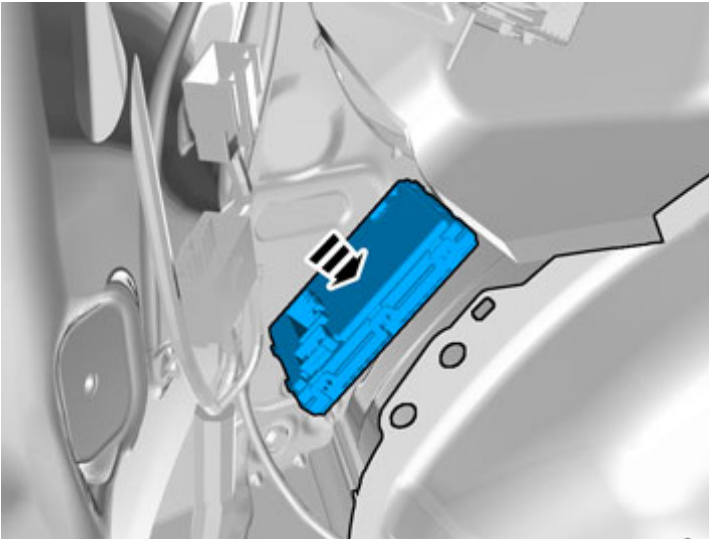

IMG-362292

Press the control module into place.

When installing Velcro tape the surface must maintain a temperature of at least +20 ° C (68°F).



Installation instructions, accessories

Volvo Car Corporation Gothenburg, Sweden

13

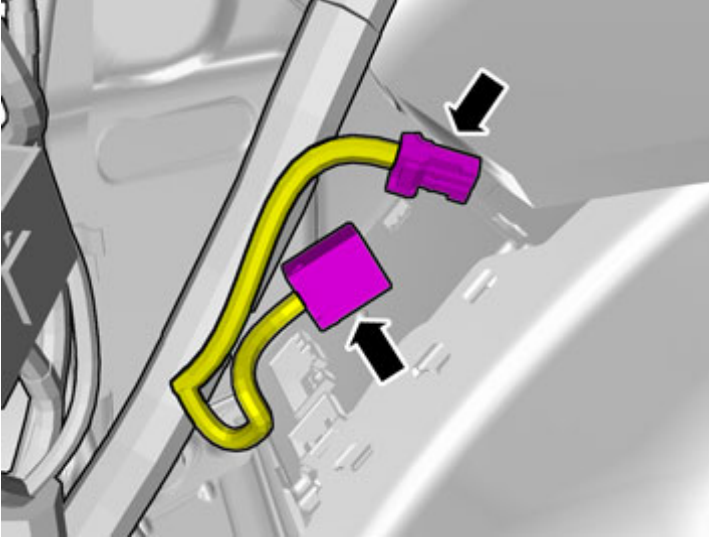

IMG-362298

Applies to cars with model year from and including 2013-

Locate the connectors in the car's wiring harness.

14

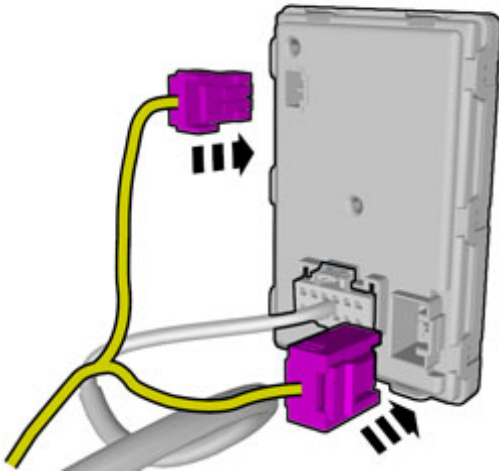

IMG-362296

Connect the located connectors.



Installation instructions, accessories

Volvo Car Corporation Gothenburg, Sweden

15

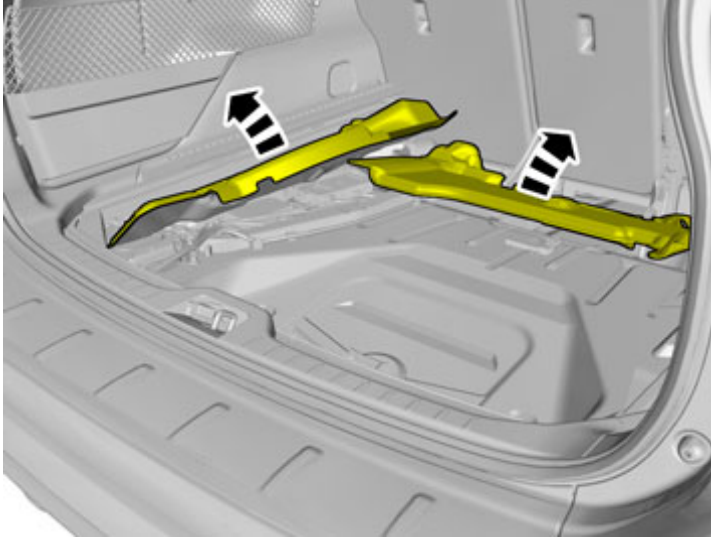

IMG-347027

Applies to cars with model year up to and including -2012

Fold aside the insulation.

16

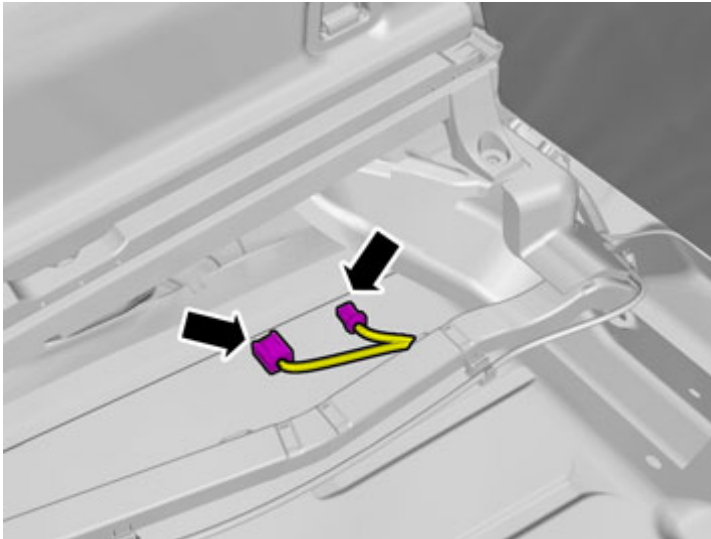

IMG-362307

Locate the connectors.



Installation instructions, accessories

Volvo Car Corporation Gothenburg, Sweden

17

Connect the extension cable to the located connector.

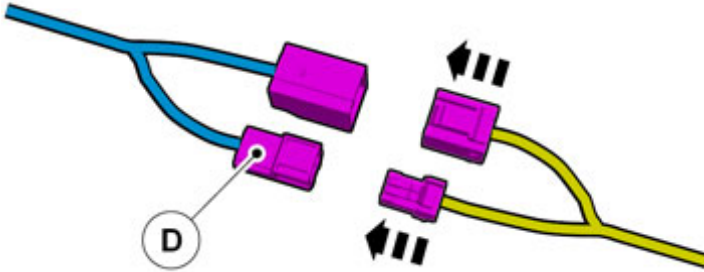

IMG-360183

18

Route the extension cable following the existing cable harness.

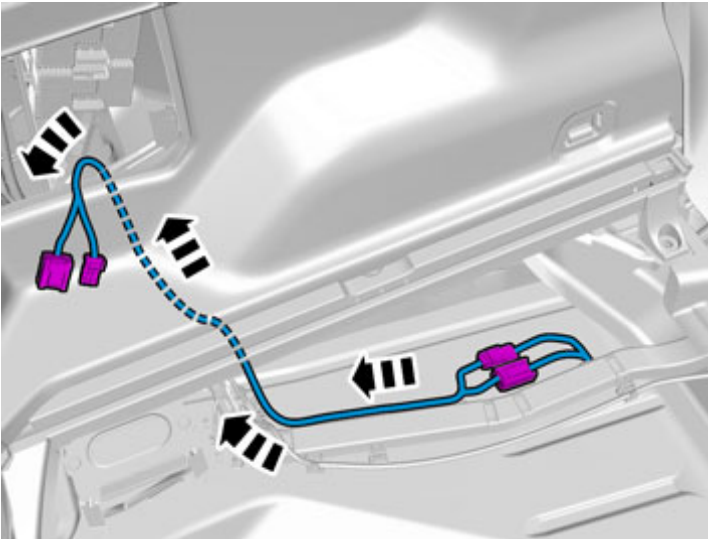

IMG-362318



Installation instructions, accessories

Volvo Car Corporation Gothenburg, Sweden

19

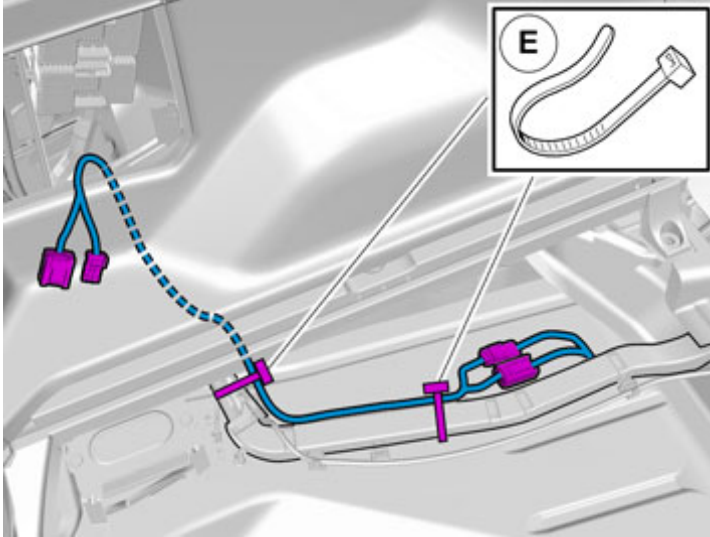

IMG-362319

Route the extension cable following the existing cable harness.
Use cable ties to secure any excess.

20

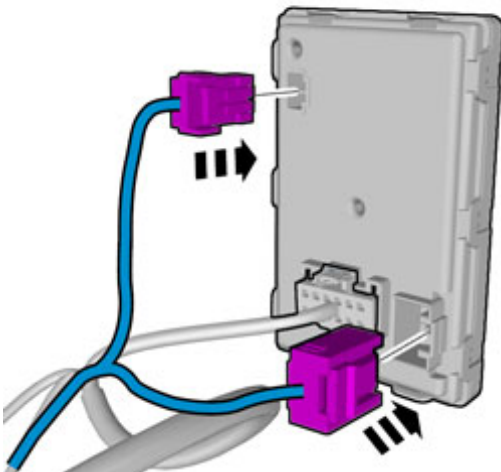

IMG-359922

Connect the connectors from the extension wiring to the control module.



Installation instructions, accessories

Volvo Car Corporation Gothenburg, Sweden

21

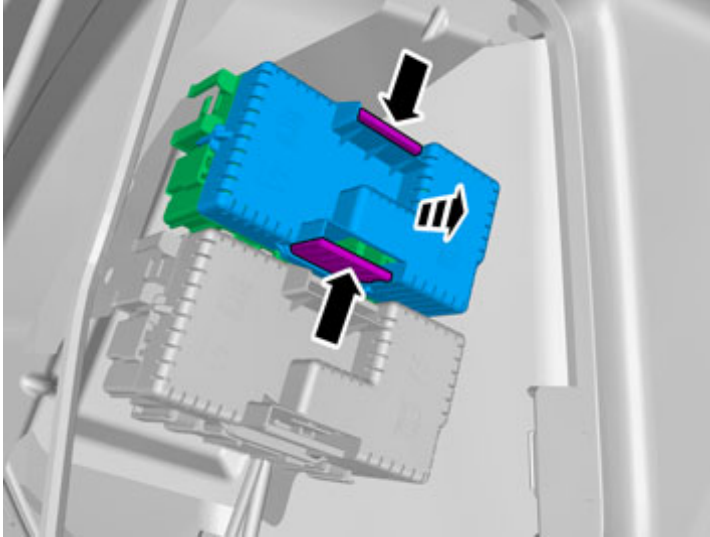

IMG-360189

Applies to all models

Press in the catches on the black cover on the fuse holder and remove it.

22

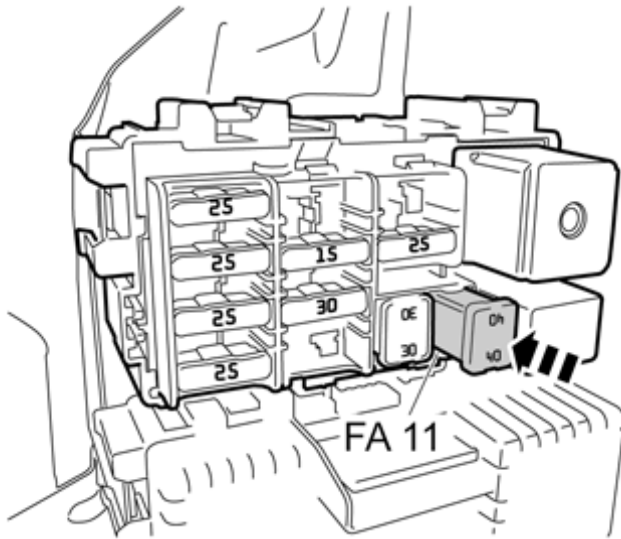

IMG-285841

Install the 40A fuse in position FA 11 in module RJB-A.

Reinstall the cover.

23

Reinstall the detached components in reverse order.



Installation instructions, accessories

Volvo Car Corporation Gothenburg, Sweden

24

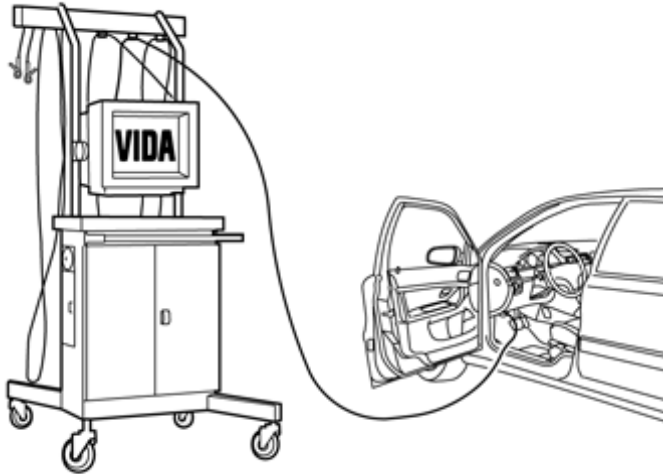

IMG-242268

Download the software (application) for the accessory's function following the service information in VIDA.

See VIDA or the accessories catalogue for software part number.