

Installation instructions, accessories

Volvo Car Corporation Gothenburg, Sweden

Instruction No 31330338
Version 1.2
Part. No. 32270874

Digital radio, DAB

Equipment

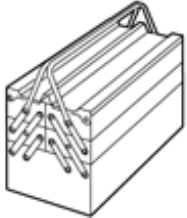

IMG-345497

VIDA

IMG-242205



IMG-239664

Nm
lbf.ft

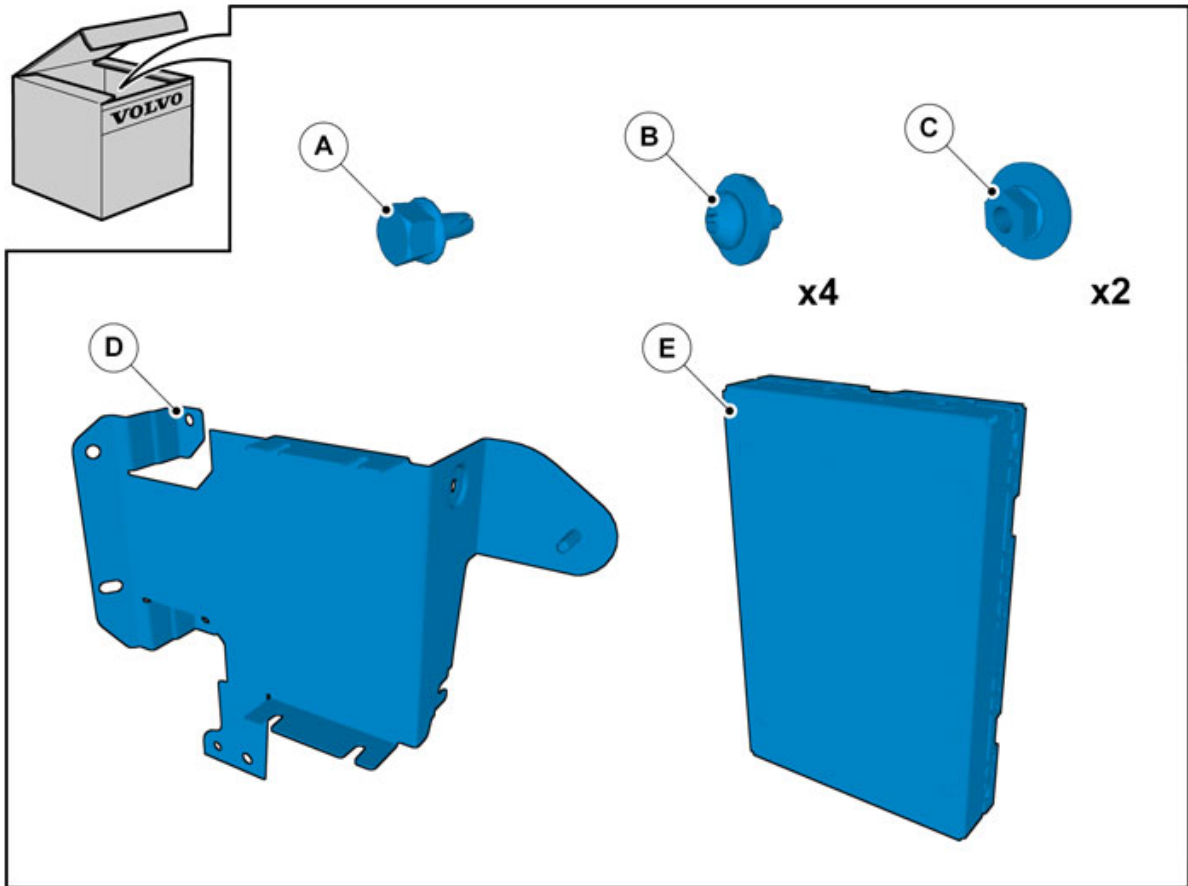

IMG-366418

Installation instructions, accessories

Volvo Car Corporation Gothenburg, Sweden

Information

1

Read through all of the instructions before starting installation.

Notifications and warning texts are for your safety and to minimise the risk of something breaking during installation.

Ensure that all tools stated in the instructions are available before starting installation.

Certain steps in the instructions are only presented in the form of images. Explanatory text is also given for more complicated steps.

In the event of any problems with the instructions or the accessory, contact your local Volvo dealer.

Color symbols

2

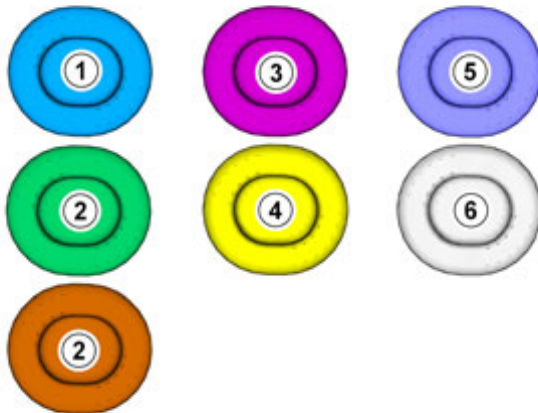

IMG-363036

Note!

This colour chart displays (in colour print and electronic version) the importance of the different colours used in the images of the method steps.

1. Used for focused component, the component with which you will do something.
 2. Used as extra colors when you need to show or differentiate additional parts.
 3. Used for attachments that are to be removed/installed. May be screws, clips, connectors, etc.
 4. Used when the component is not fully removed from the vehicle but only hung to the side.
 5. Used for standard tools and special tools.
 6. Used as background color for vehicle components.
-

Preparation

Installation instructions, accessories

Volvo Car Corporation Gothenburg, Sweden

3

Set the ignition key to position 0.

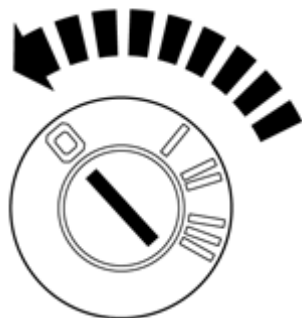

IMG-245980

Removal

4

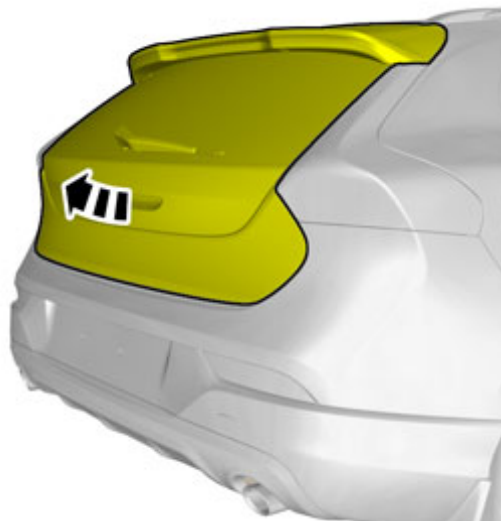

IMG-354413

Installation instructions, accessories

Volvo Car Corporation Gothenburg, Sweden

5



IMG-366366

Remove the panel.

6

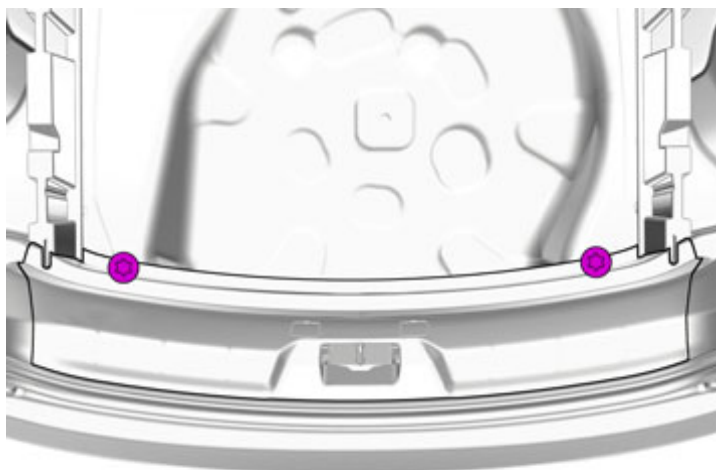

IMG-366375

Remove the screws.

Installation instructions, accessories

Volvo Car Corporation Gothenburg, Sweden

7

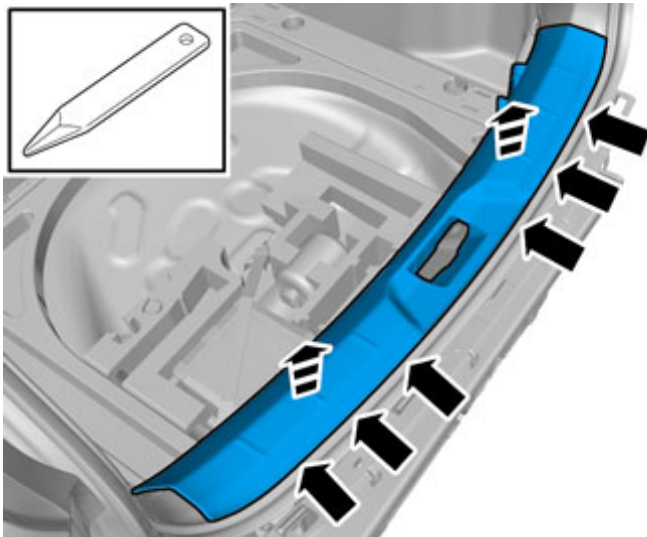

IMG-356006

Remove the panel.

8

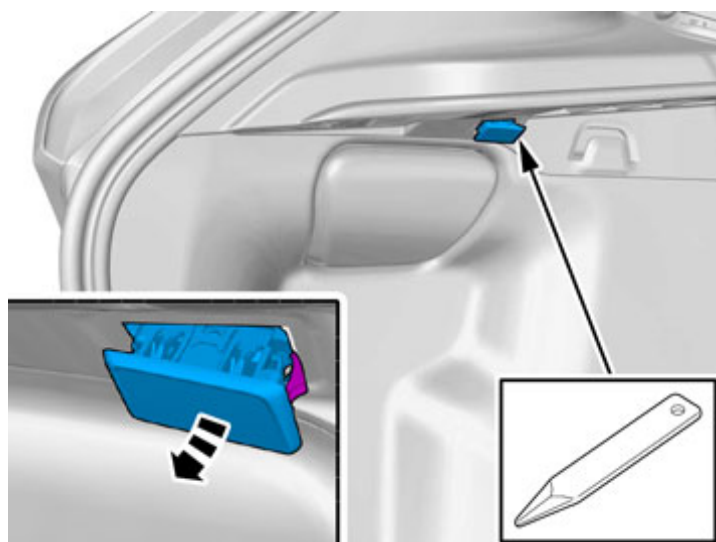

IMG-366506

Remove the part carefully

Installation instructions, accessories

Volvo Car Corporation Gothenburg, Sweden

9

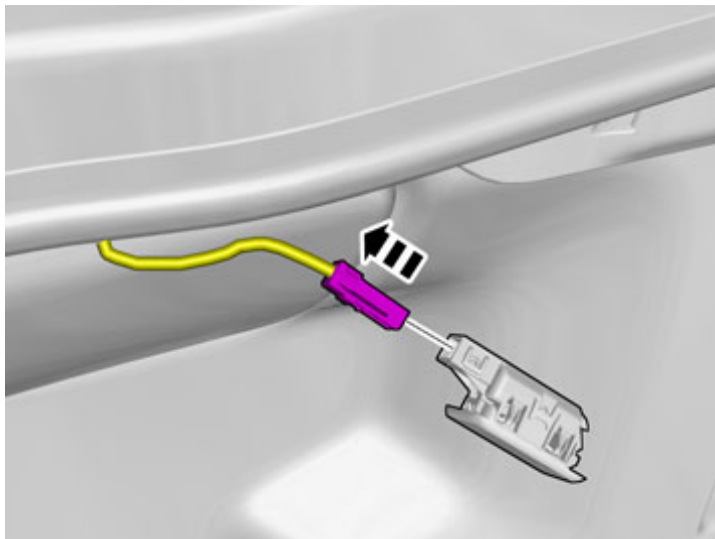

IMG-366502

Disconnect the connector.

10

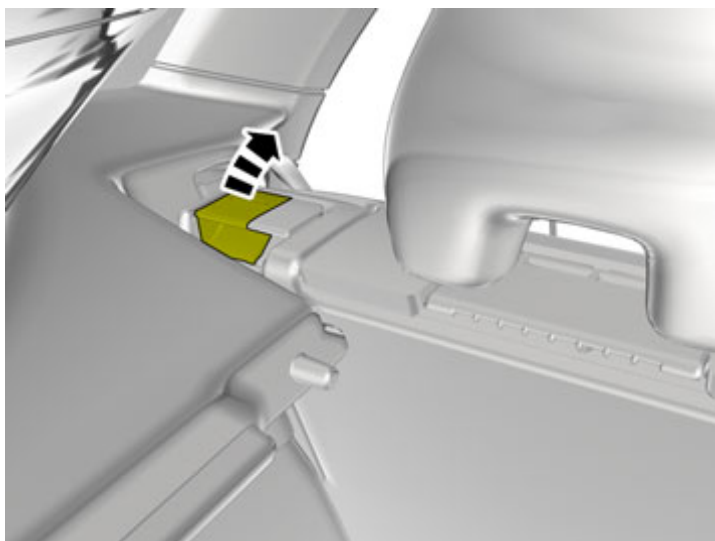

IMG-366377

Installation instructions, accessories

Volvo Car Corporation Gothenburg, Sweden

11

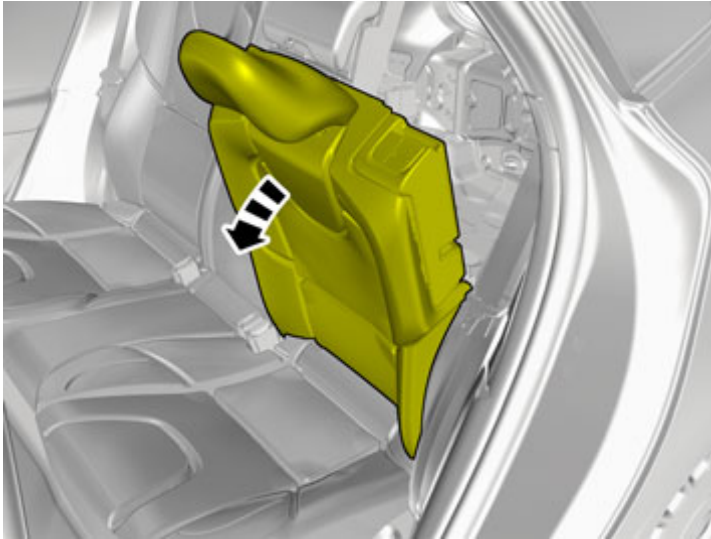

IMG-366386

12

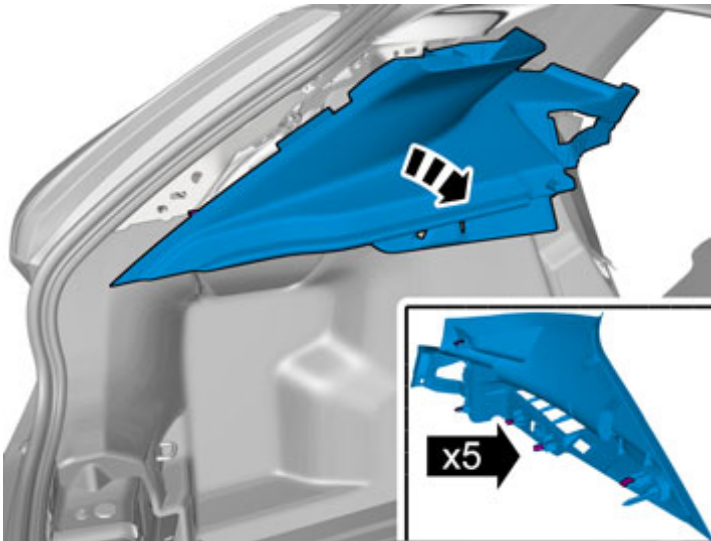

IMG-366392

Remove the panel.

Installation instructions, accessories

Volvo Car Corporation Gothenburg, Sweden

13

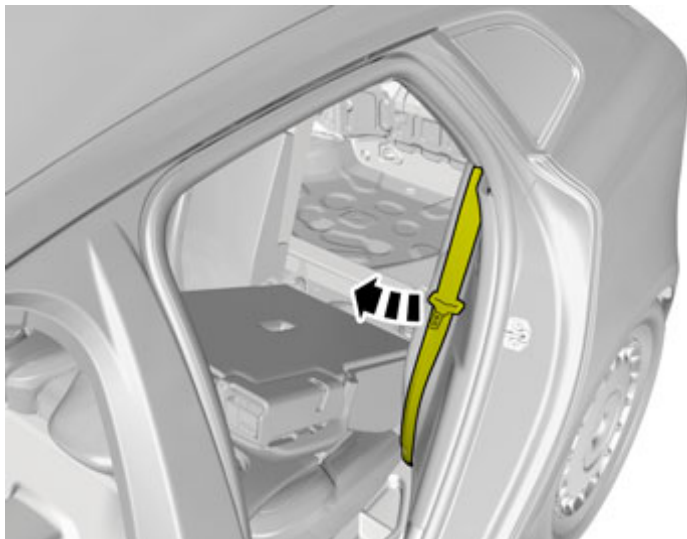

IMG-366507

14

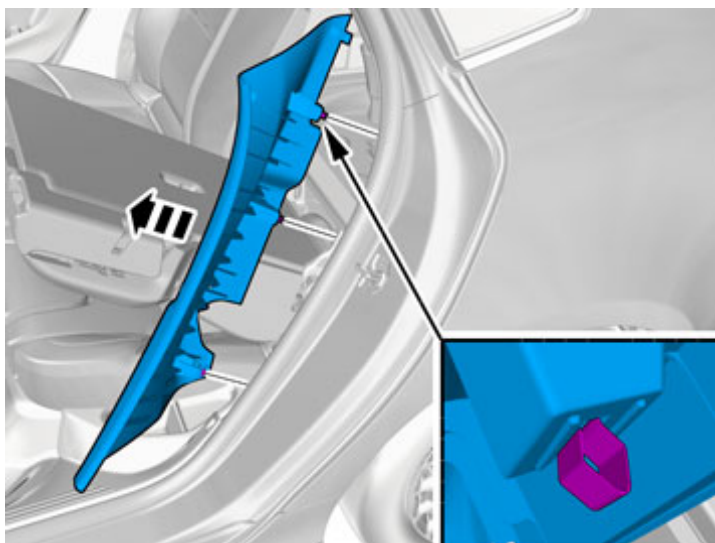

IMG-366511

Remove the panel.

Installation instructions, accessories

Volvo Car Corporation Gothenburg, Sweden

15

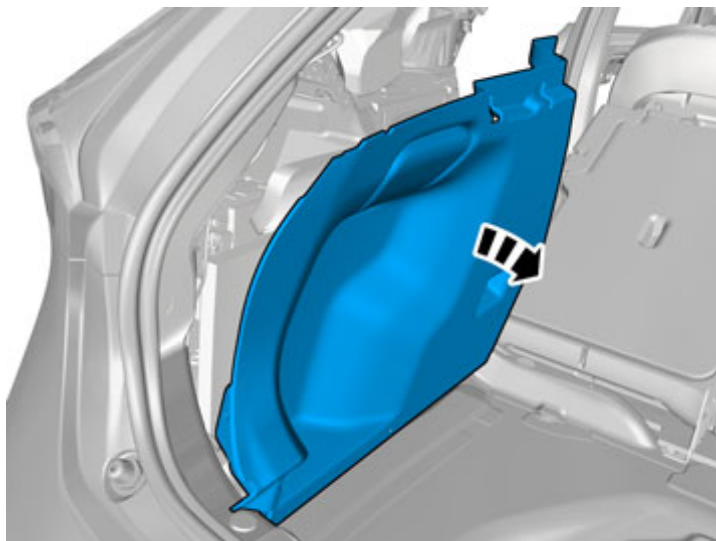

IMG-366513

Remove the panel.

Accessory installation

16

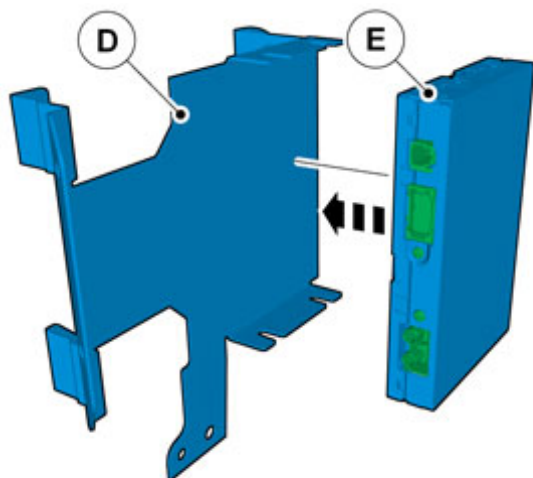

IMG-366539

Install component that comes with the accessory kit.

Installation instructions, accessories

Volvo Car Corporation Gothenburg, Sweden

17

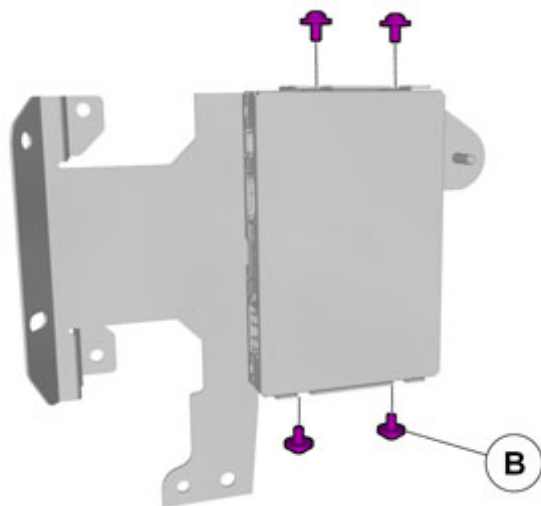

IMG-366359

Install component that comes with the accessory kit.

Install the screws.

18

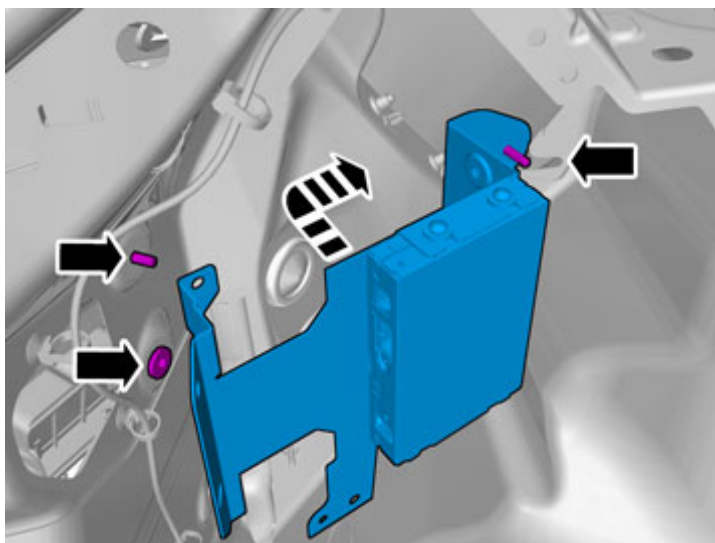

IMG-366557

Note the position.

Installation instructions, accessories

Volvo Car Corporation Gothenburg, Sweden

19

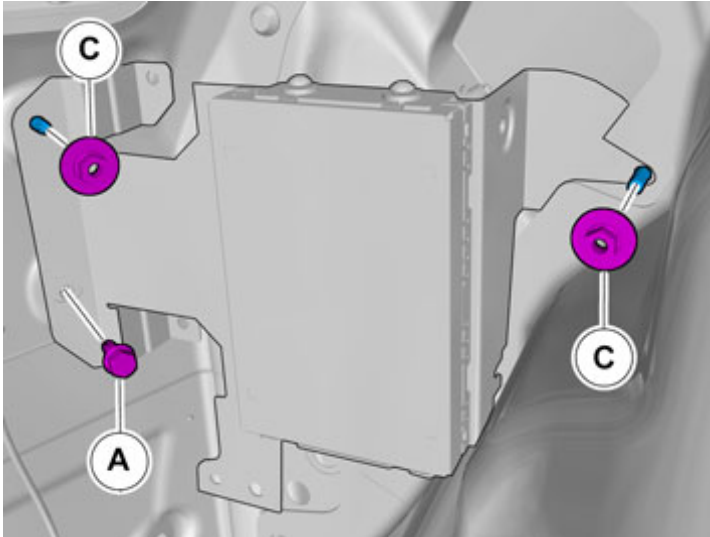

IMG-366551

Install the screw.

Install the nuts

Tightening torque: M6 , 10 Nm

20

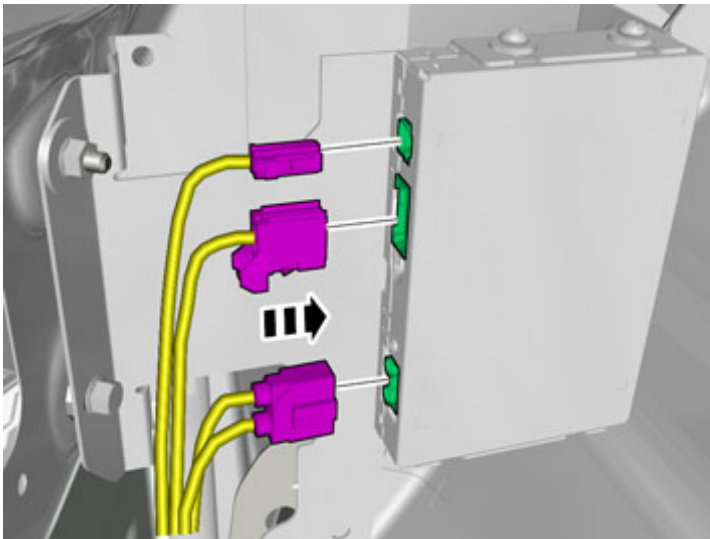

IMG-366571

Locate the pre-routed connectors.

Connect the connectors.

Installation

21

Reinstall the removed parts in reverse order.

Installation instructions, accessories

Volvo Car Corporation Gothenburg, Sweden

22

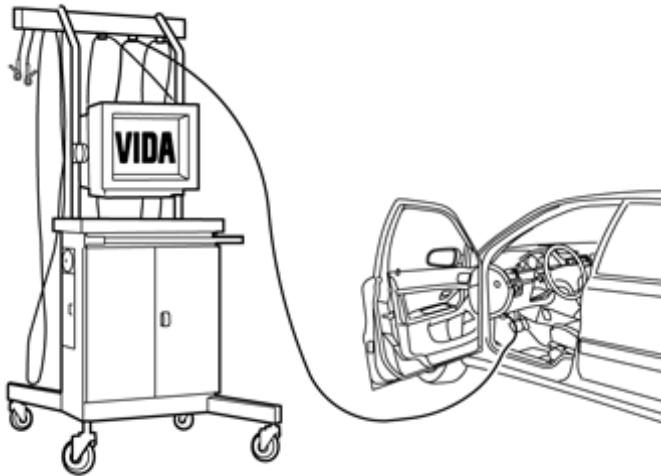

IMG-242268

Note!

First, download the software for preparatory installation according to the accessory catalogue. Then do the download/reload of software for the accessory function.

Note!

When doing an aftermarket installation of DAB or DAB+, it is necessary to carry out a DAB application download.

Note!

When upgrading from DAB to DAB+, a DAB re-load is necessary.

Carry out a download, or a re-load, of accessory function software by following VIDA service information.