

Installation instructions, accessories

Volvo Car Corporation Gothenburg, Sweden

Instruction No 31439014
Version 1.0
Part. No. 31373978

Sun curtain, rear window

Equipment



IMG-239667



IMG-397698

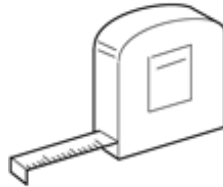

IMG-244945

A

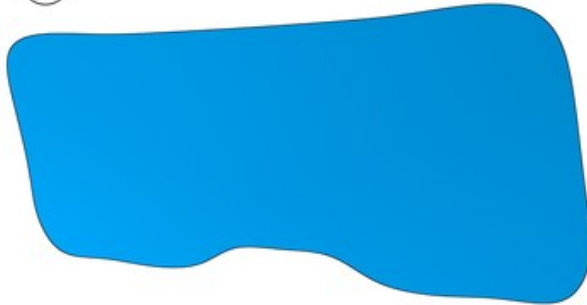

B

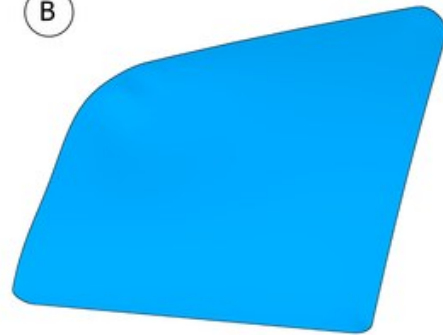

C

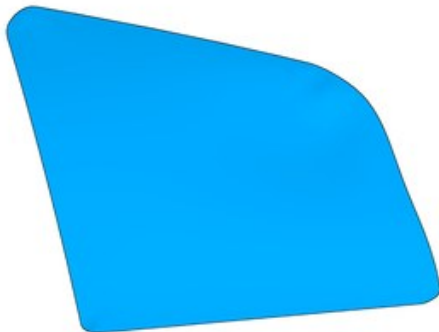

IMG-397786

D



x9

Installation instructions, accessories

Volvo Car Corporation Gothenburg, Sweden

Information

1

Read through all of the instructions before starting installation.

Notifications and warning texts are for your safety and to minimise the risk of something breaking during installation.

Ensure that all tools stated in the instructions are available before starting installation.

Certain steps in the instructions are only presented in the form of images. Explanatory text is also given for more complicated steps.

In the event of any problems with the instructions or the accessory, contact your local Volvo dealer.

Accessory installation

2



IMG-384915

3



IMG-397790

Note!
Orientation view

Installation instructions, accessories

Volvo Car Corporation Gothenburg, Sweden

4



IMG-397690

Use tape

5

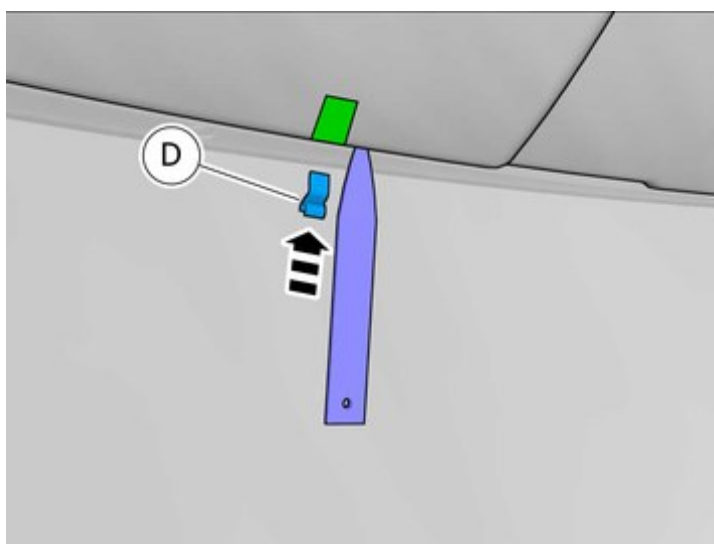

IMG-397685

Install component that comes with the accessory kit.

Use: Interior trim remover

Installation instructions, accessories

Volvo Car Corporation Gothenburg, Sweden

6

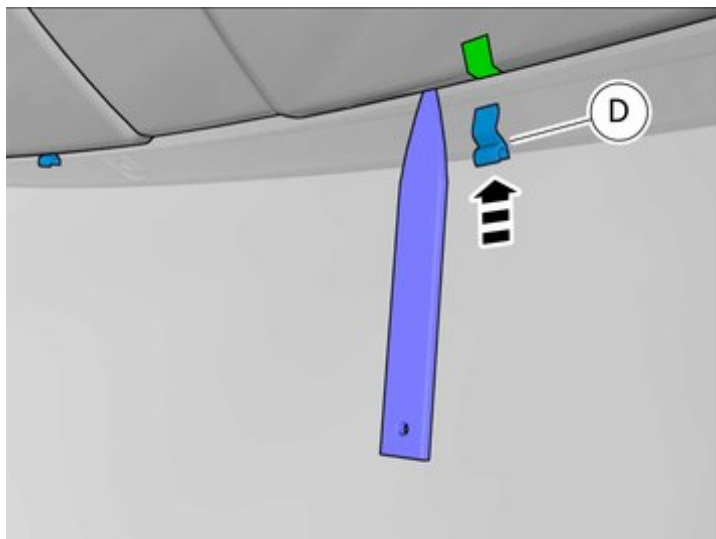

IMG-397686

Install component that comes with the accessory kit.

Use: Interior trim remover

7

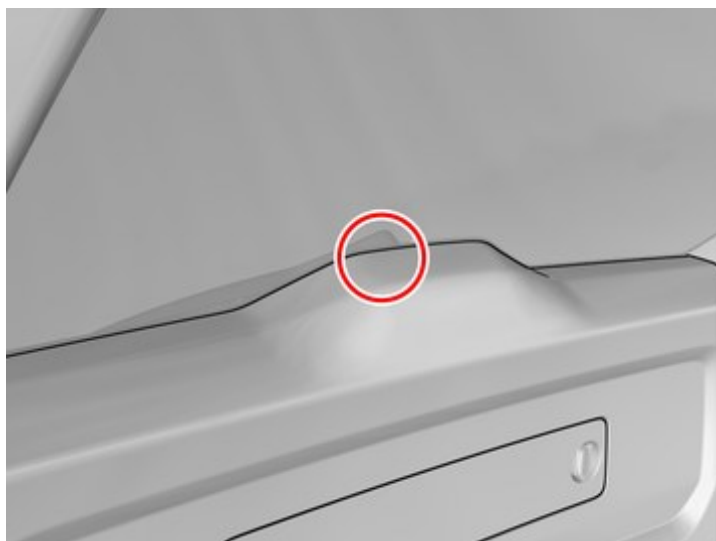

IMG-397701

Installation instructions, accessories

Volvo Car Corporation Gothenburg, Sweden

8

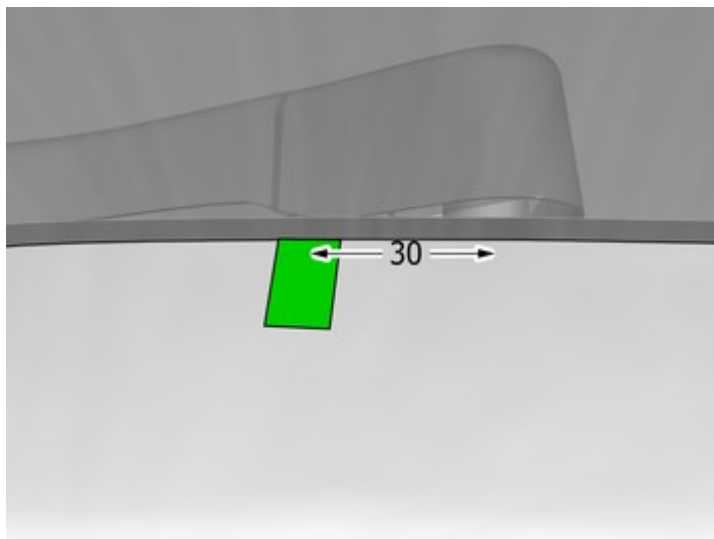

IMG-397700

Use tape

9

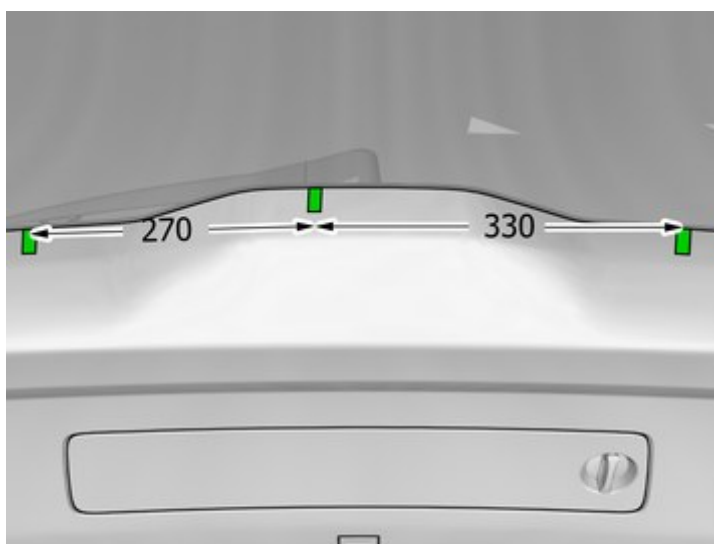

IMG-397703

Use tape

Installation instructions, accessories

Volvo Car Corporation Gothenburg, Sweden

10

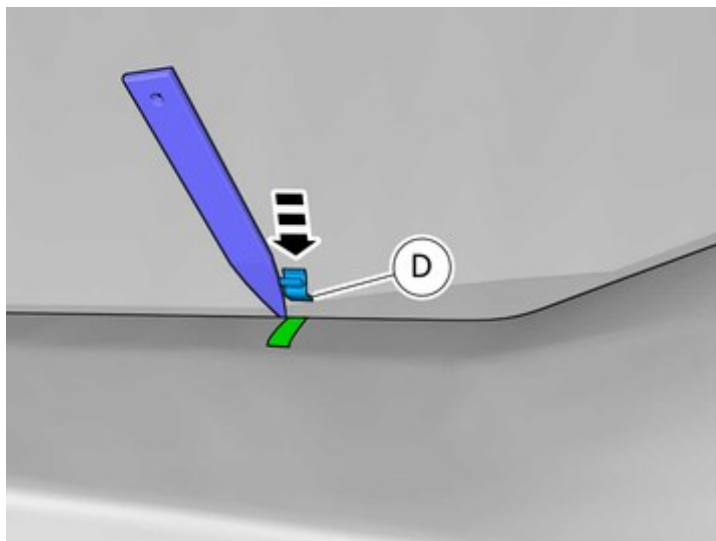

IMG-397706

Install component that comes with the accessory kit.

11

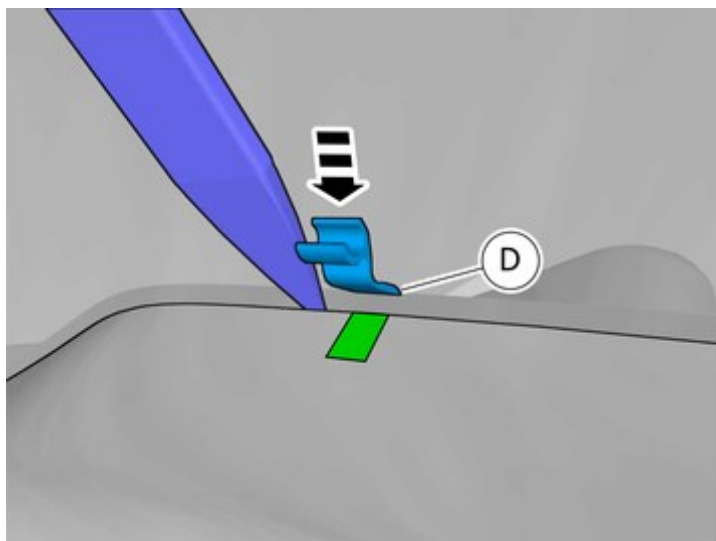

IMG-397707

Install component that comes with the accessory kit.

Installation instructions, accessories

Volvo Car Corporation Gothenburg, Sweden

12

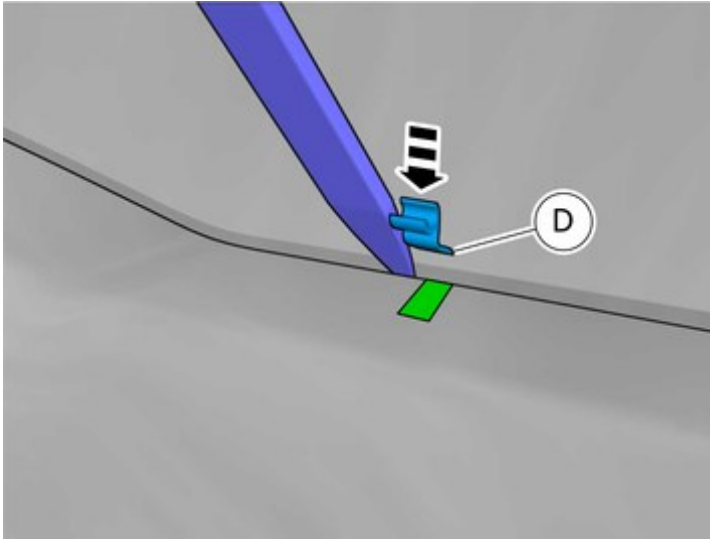

IMG-397708

Install component that comes with the accessory kit.

13

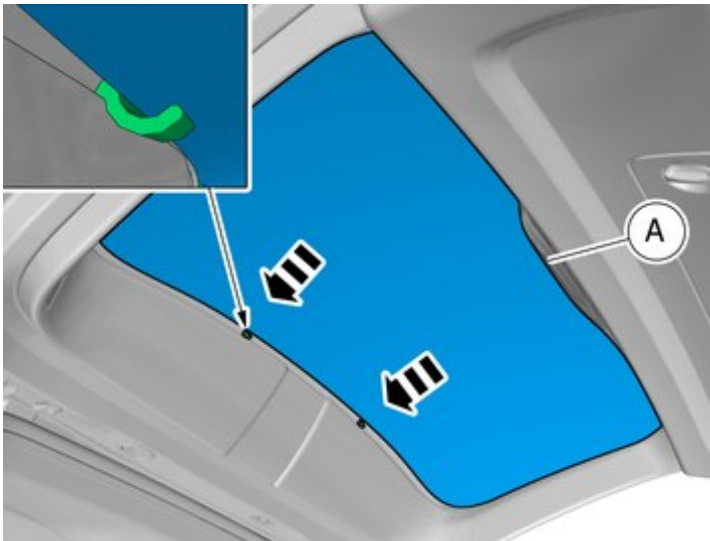

IMG-397733

Install component that comes with the accessory kit.

Installation instructions, accessories

Volvo Car Corporation Gothenburg, Sweden

14

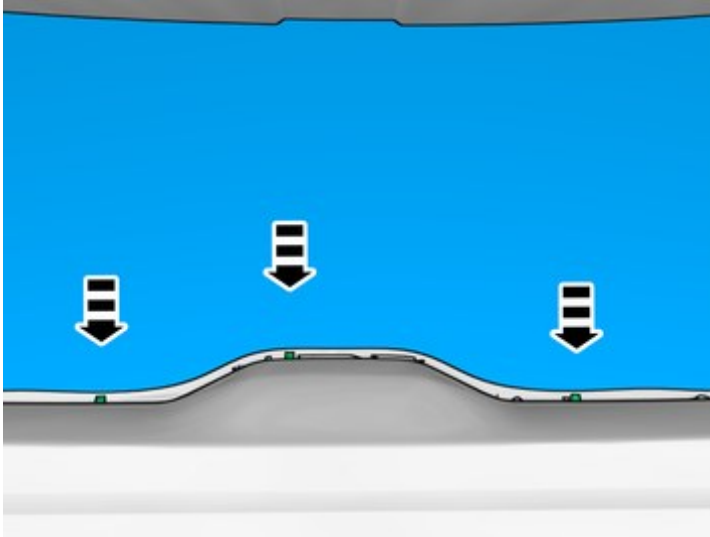

IMG-397732

Ensure that all clips engage.

15



IMG-397766

Note!
Orientation view

Installation instructions, accessories

Volvo Car Corporation Gothenburg, Sweden

16

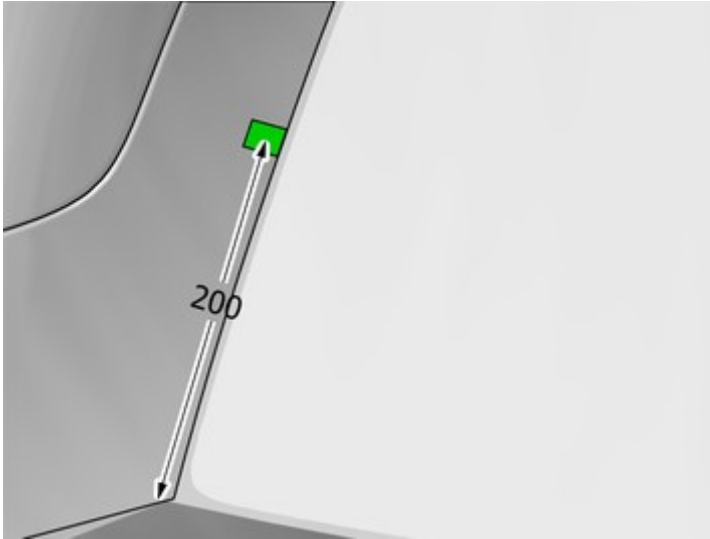

IMG-397765

Use tape

17

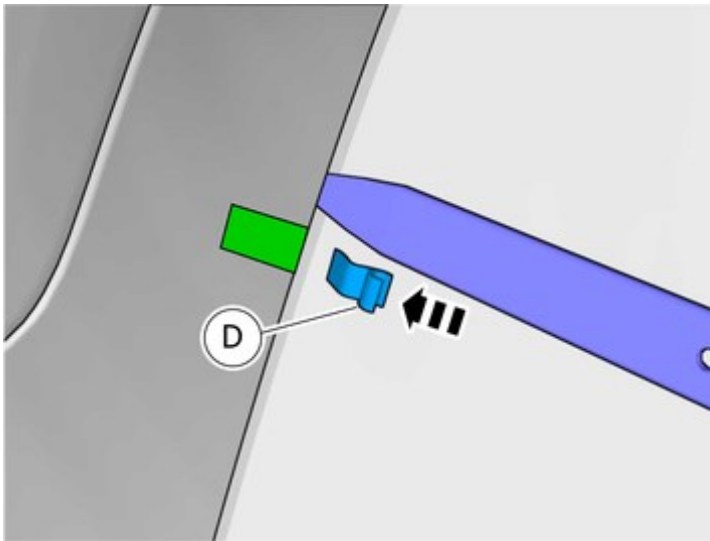

IMG-397768

Install component that comes with the accessory kit.

Installation instructions, accessories

Volvo Car Corporation Gothenburg, Sweden

18

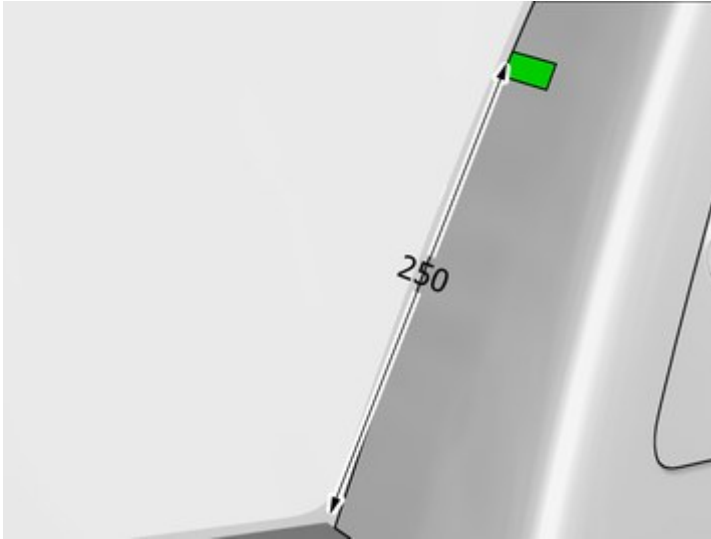

IMG-397771

Use tape

19

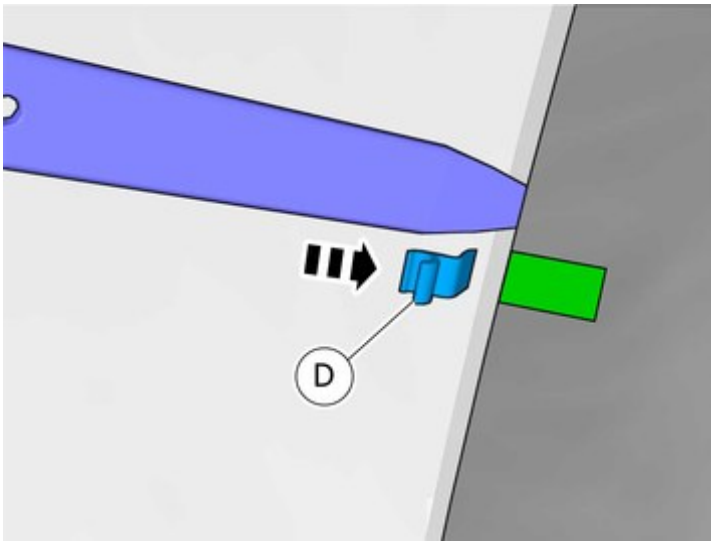

IMG-397772

Install component that comes with the accessory kit.

Installation instructions, accessories

Volvo Car Corporation Gothenburg, Sweden

20

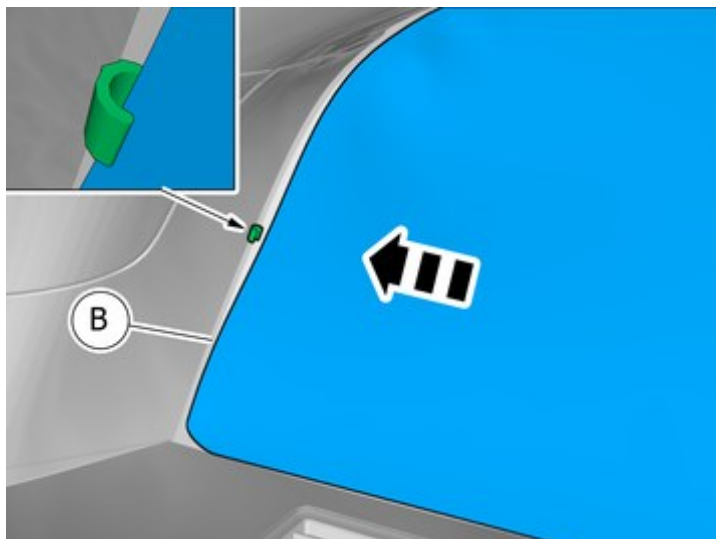

IMG-397780

Install component that comes with the accessory kit.

21

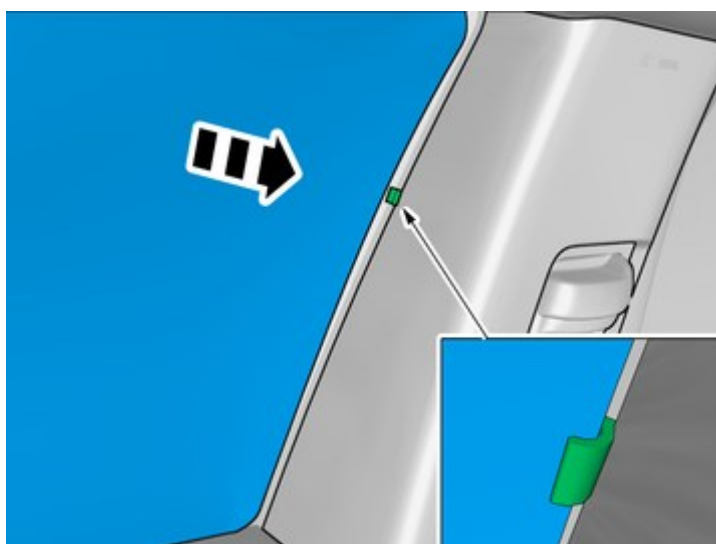

IMG-397783

22

Repeat the steps when installing accessories on opposite side.