

Installation instructions, accessories

Volvo Car Corporation Gothenburg, Sweden

Instruction No 31428237
Version 1.2
Part. No. 31373486

Load compartment divider

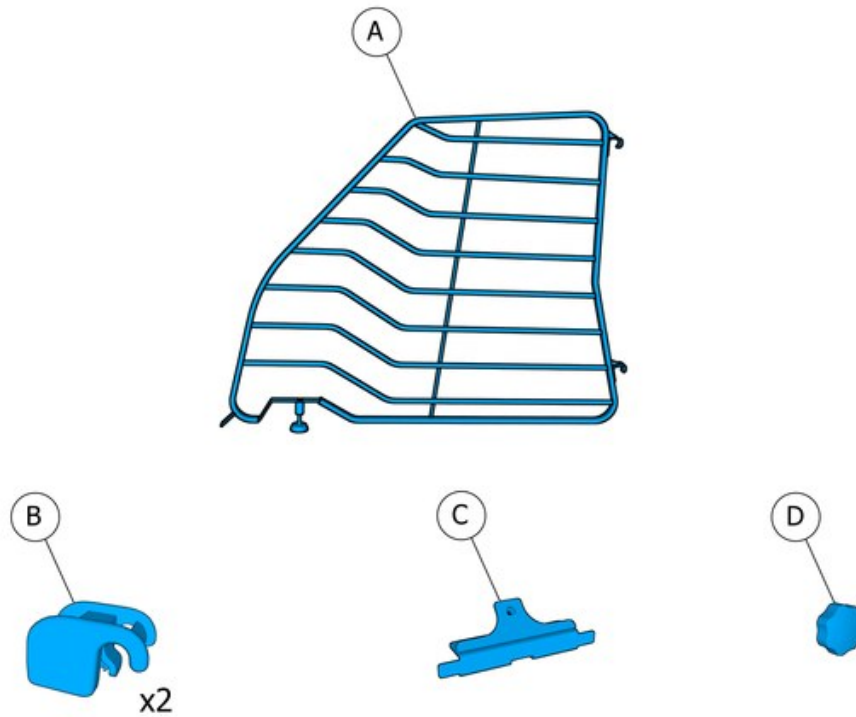

IMG-383818

Installation instructions, accessories

Volvo Car Corporation Gothenburg, Sweden

Information

1

Read through all of the instructions before starting installation.

Notifications and warning texts are for your safety and to minimise the risk of something breaking during installation.

Ensure that all tools stated in the instructions are available before starting installation.

Certain steps in the instructions are only presented in the form of images. Explanatory text is also given for more complicated steps.

In the event of any problems with the instructions or the accessory, contact your local Volvo dealer.

Color symbols

2

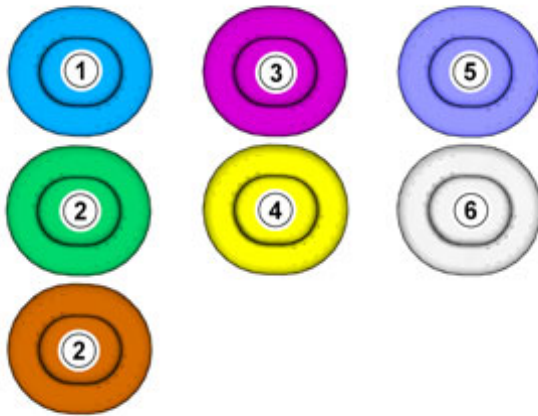

IMG-363036

Note!

This colour chart displays (in colour print and electronic version) the importance of the different colours used in the images of the method steps.

1. Used for focused component, the component with which you will do something.
 2. Used as extra colors when you need to show or differentiate additional parts.
 3. Used for attachments that are to be removed/installed. May be screws, clips, connectors, etc.
 4. Used when the component is not fully removed from the vehicle but only hung to the side.
 5. Used for standard tools and special tools.
 6. Used as background color for vehicle components.
-

Preparation

Installation instructions, accessories

Volvo Car Corporation Gothenburg, Sweden

3

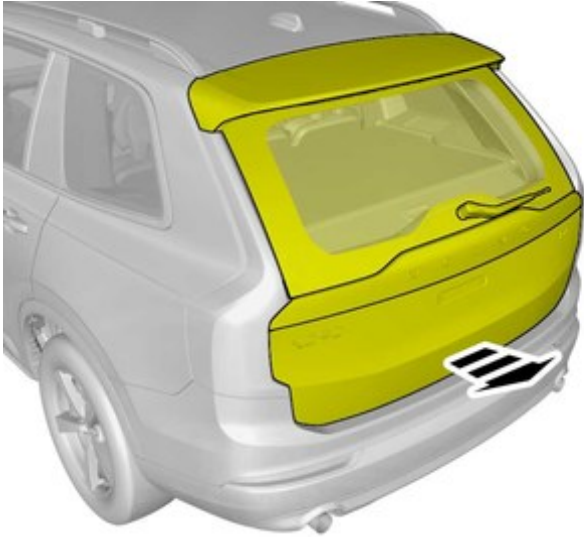

IMG-394779

4

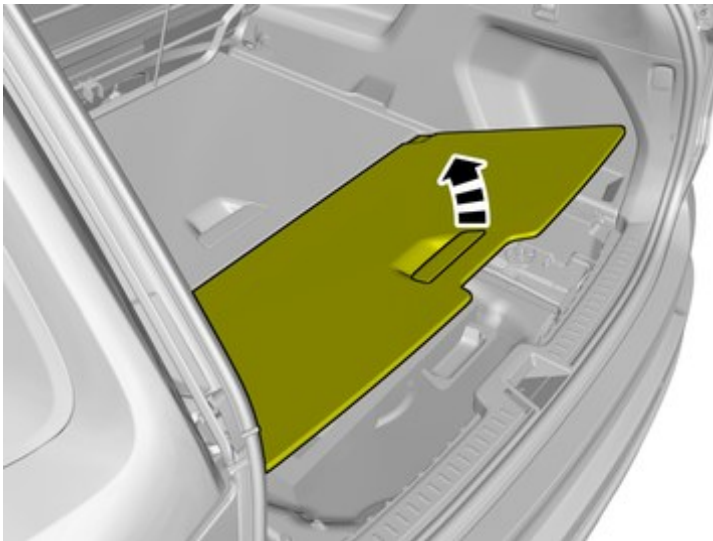

IMG-384380

Installation instructions, accessories

Volvo Car Corporation Gothenburg, Sweden

5

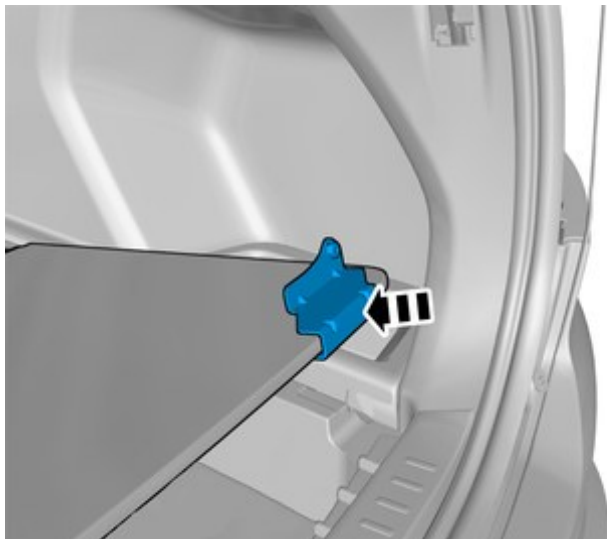

IMG-389788

Note!

Carry out this step if installation of dog gate follows.

Accessory installation

6

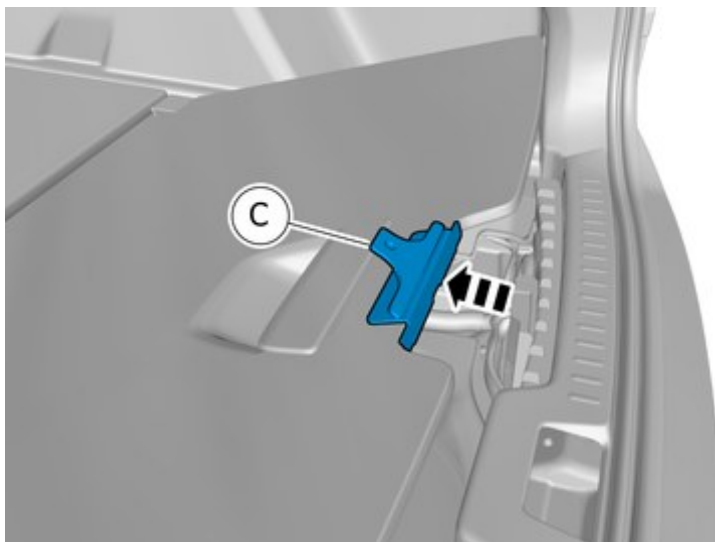

IMG-400695

Install component that comes with the accessory kit.

Installation instructions, accessories

Volvo Car Corporation Gothenburg, Sweden

7

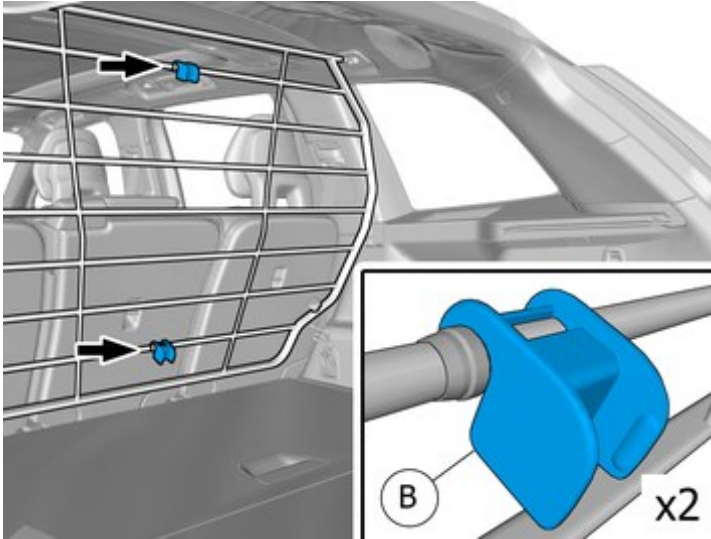

IMG-429140

Install component that comes with the accessory kit.

8

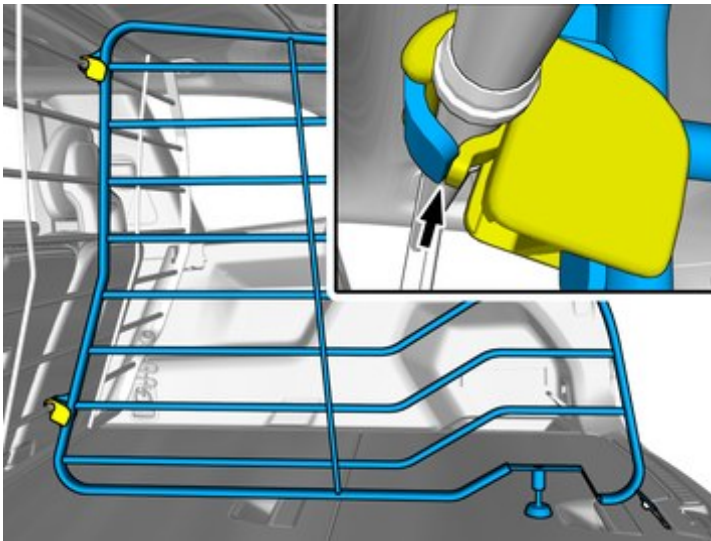

IMG-429141

Install component that comes with the accessory kit.
Place the component where indicated in the graphic.

Installation instructions, accessories

Volvo Car Corporation Gothenburg, Sweden

9

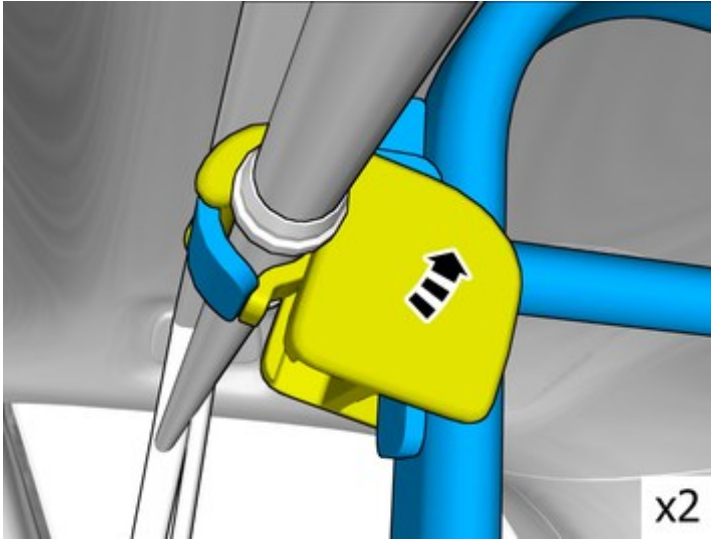

Note!

This step requires considerable force.

10

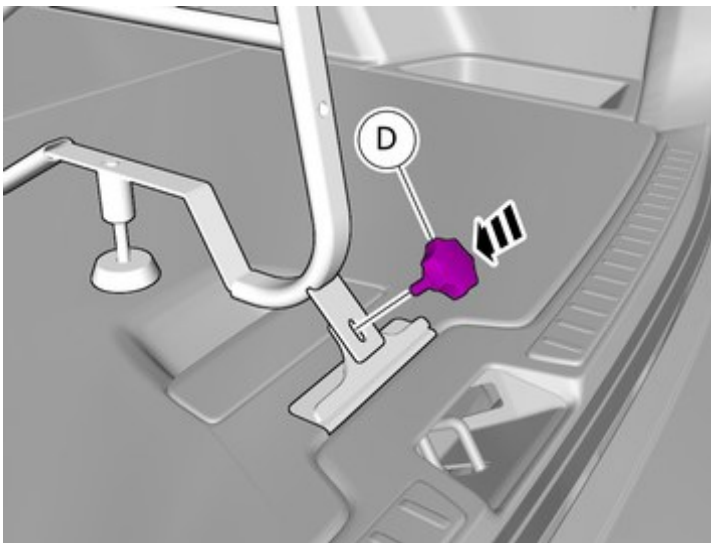

Install the nut.

Installation instructions, accessories

Volvo Car Corporation Gothenburg, Sweden

11

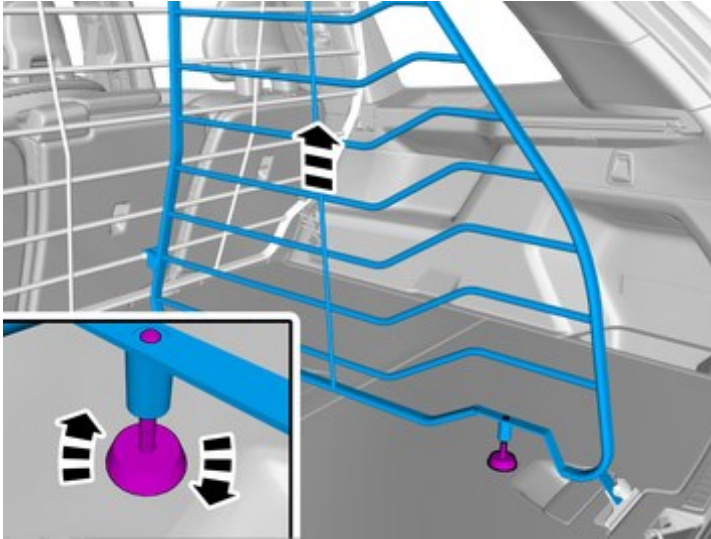

IMG-429145

Note!
Adjust the component indicated until no clearance or play is evident.

Removal

12

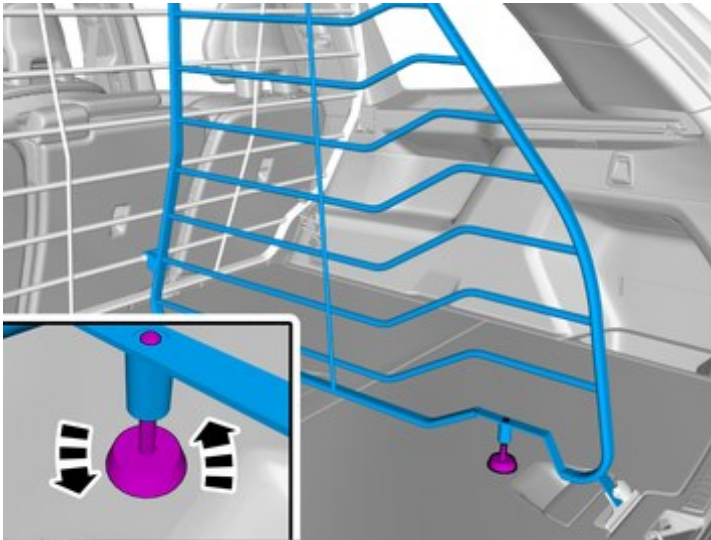

IMG-429146

Installation instructions, accessories

Volvo Car Corporation Gothenburg, Sweden

13

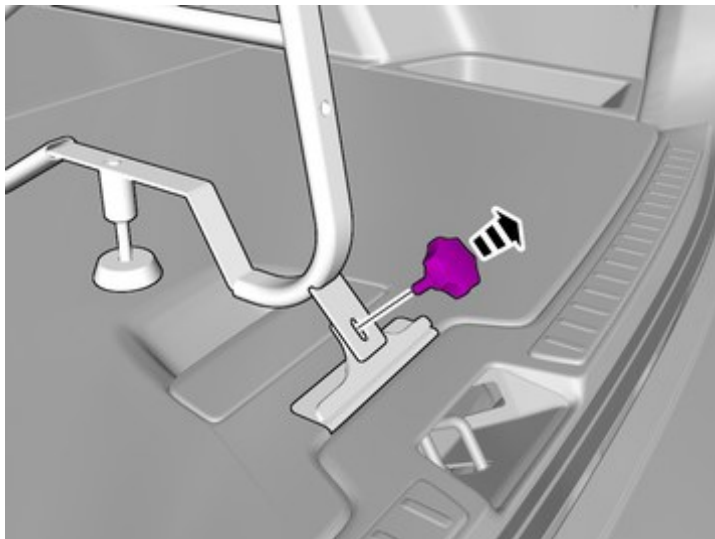

IMG-429147

14

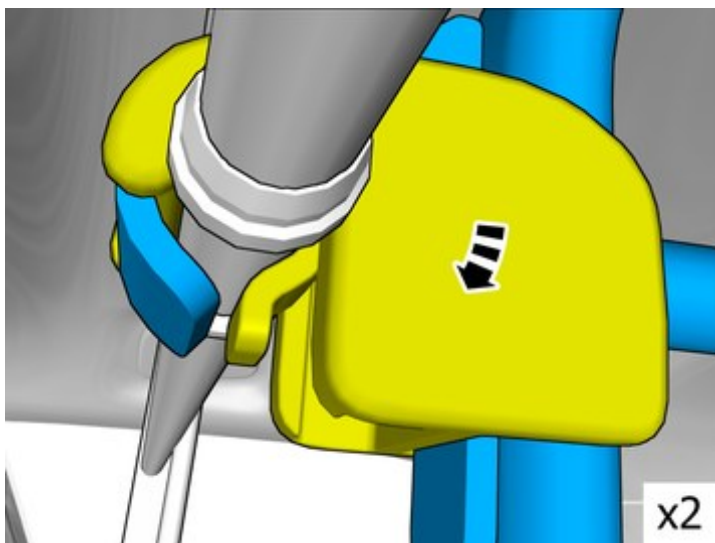

IMG-429148

Note!

This step requires considerable force.

Press the component downward until stop.

Installation instructions, accessories

Volvo Car Corporation Gothenburg, Sweden

15

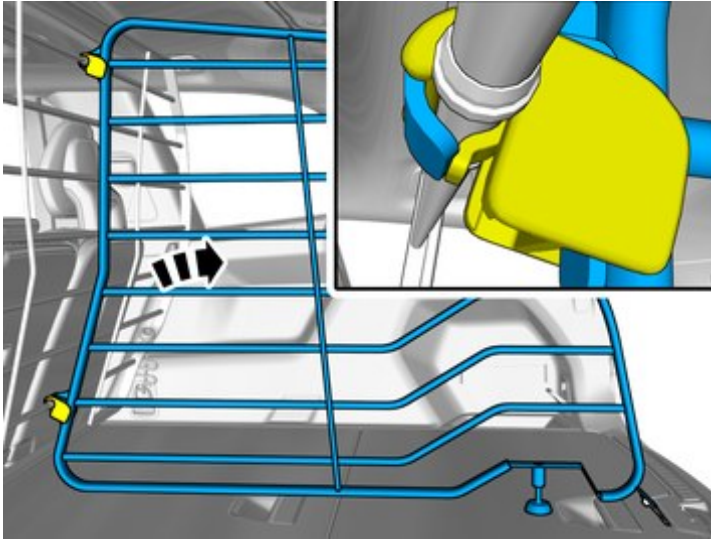

IMG-429149