

# Installation instructions, accessories

Volvo Car Corporation Gothenburg, Sweden

**Instruction No**  
31408776

**Version**  
1.2

**Part. No.**  
31408769

## Side scuff plate

### Materials

Designation	Part number
Isopropanol	1161721
Masking tape	
Paint primer	1161727

### Equipment

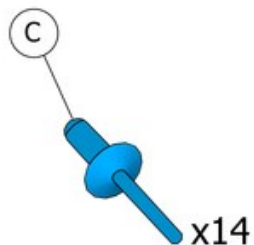
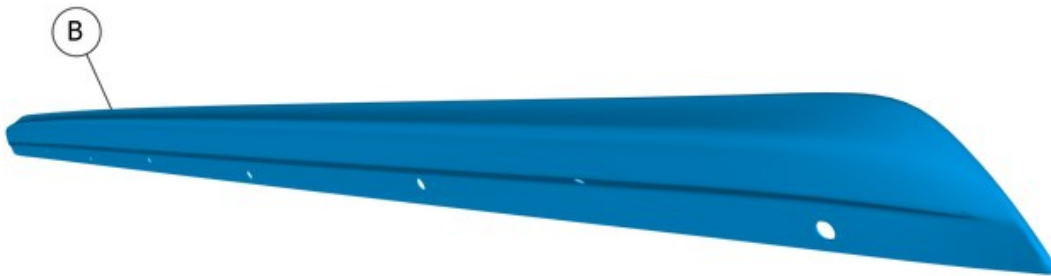

IMG-420664

# Installation instructions, accessories

Volvo Car Corporation Gothenburg, Sweden

# Installation instructions, accessories

Volvo Car Corporation Gothenburg, Sweden

---

## Information

---

1

Read through all of the instructions before starting installation.

Notifications and warning texts are for your safety and to minimise the risk of something breaking during installation.

Ensure that all tools stated in the instructions are available before starting installation.

Certain steps in the instructions are only presented in the form of images. Explanatory text is also given for more complicated steps.

In the event of any problems with the instructions or the accessory, contact your local Volvo dealer.

---

## Color symbols

---

2

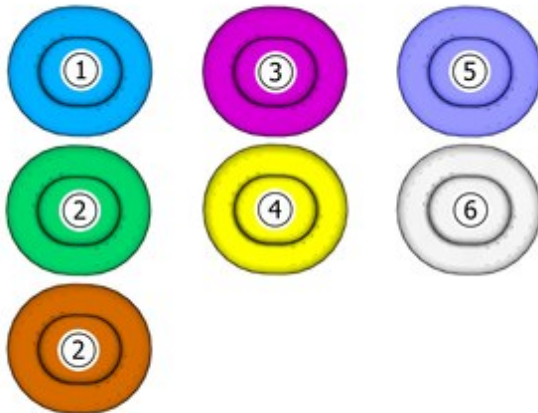

IMG-363036

### Note!

This colour chart displays (in colour print and electronic version) the importance of the different colours used in the images of the method steps.

1. Used for focused component, the component with which you will do something.
  2. Used as extra colors when you need to show or differentiate additional parts.
  3. Used for attachments that are to be removed/installed. May be screws, clips, connectors, etc.
  4. Used when the component is not fully removed from the vehicle but only hung to the side.
  5. Used for standard tools and special tools.
  6. Used as background color for vehicle components.
- 

## Preparation

---

# Installation instructions, accessories

Volvo Car Corporation Gothenburg, Sweden

3

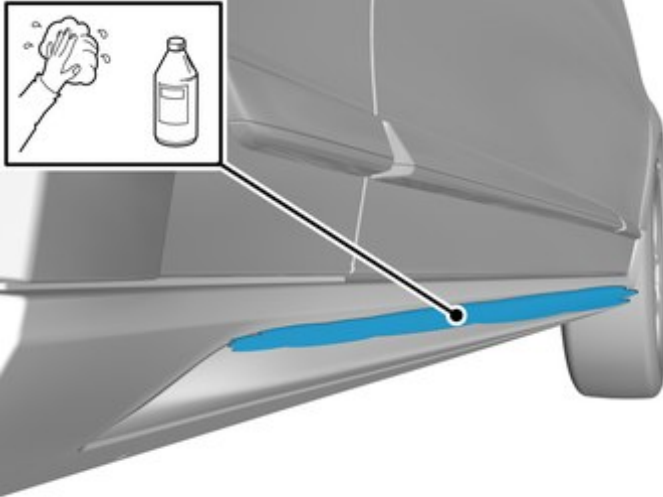

IMG-420673

Clean the surface.

Allow to dry.

**Use:** 1161721, Isopropanol

4

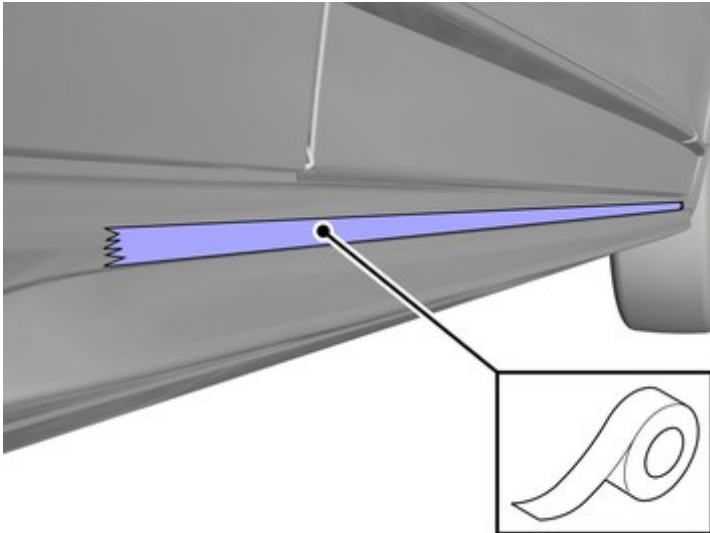

IMG-423741

Masking

**Use:** , Masking tape

# Installation instructions, accessories

Volvo Car Corporation Gothenburg, Sweden

5

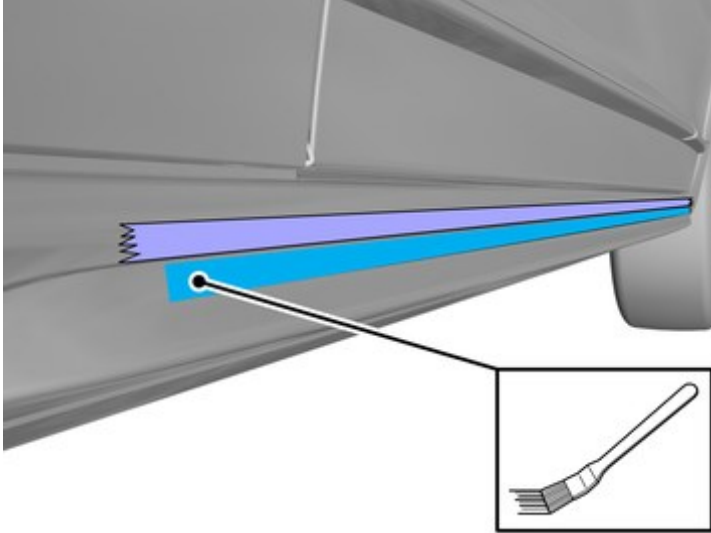

IMG-421573

Apply a thin and even layer.

**Use:** 1161727, Paint primer

Allow to dry for at least 5 minutes but not more than 30 minutes.

6

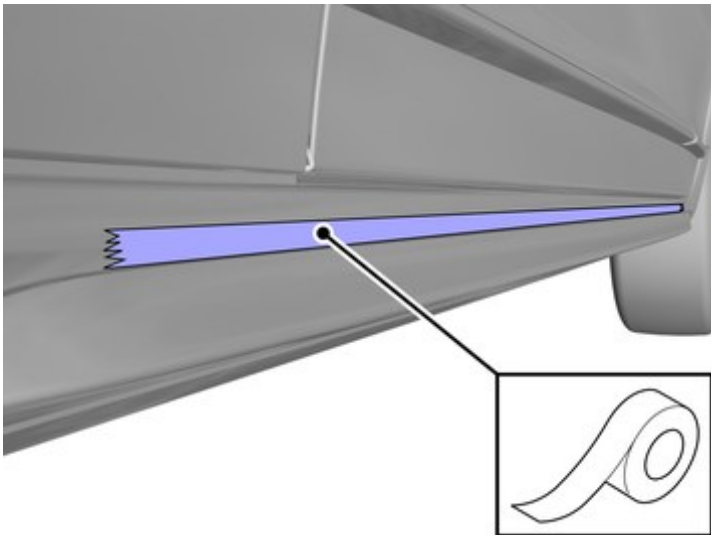

IMG-423741

Remove the tape.

7

Repeat all method steps for the other side.

**Accessory installation**

# Installation instructions, accessories

Volvo Car Corporation Gothenburg, Sweden

8

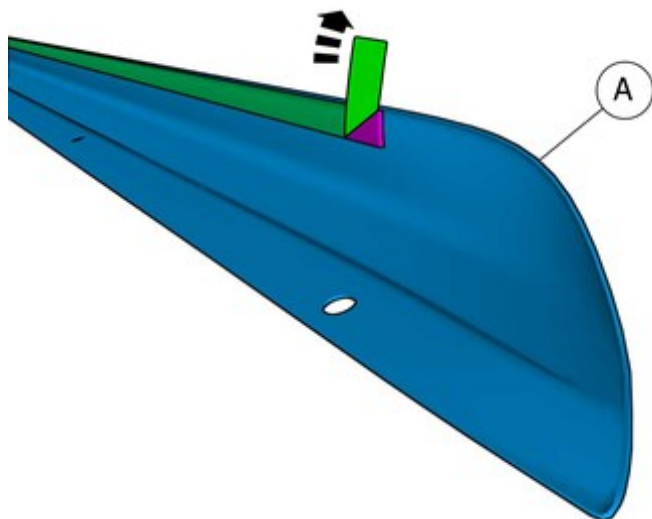

IMG-420694

Fold the protective film forward

To be repeated in the other end of the component.

9

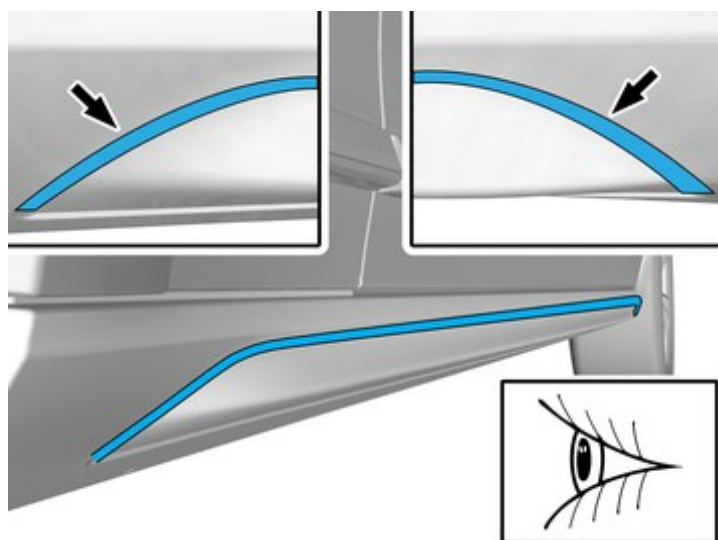

IMG-424875

**Caution!**

Take extra care not to damage the edges of the component.

# Installation instructions, accessories

Volvo Car Corporation Gothenburg, Sweden

10

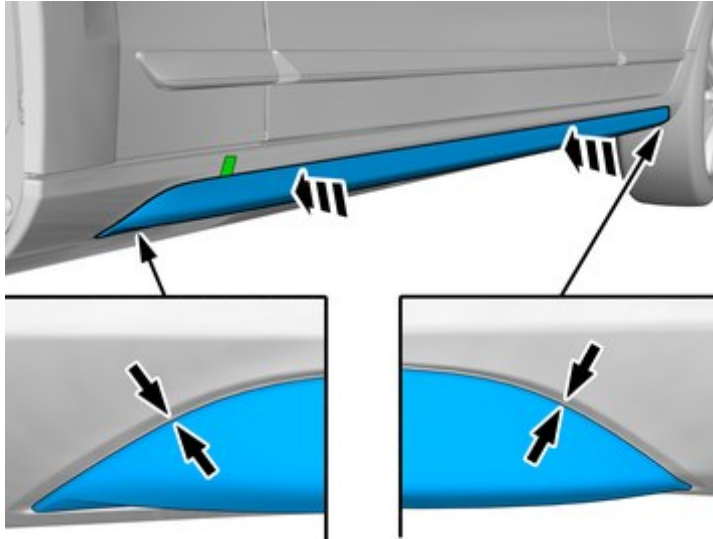

IMG-420691

**Note!**

This step is easier with two people.

**Note!**

Make sure that the component is centred.

Place the component where indicated in the graphic.

11

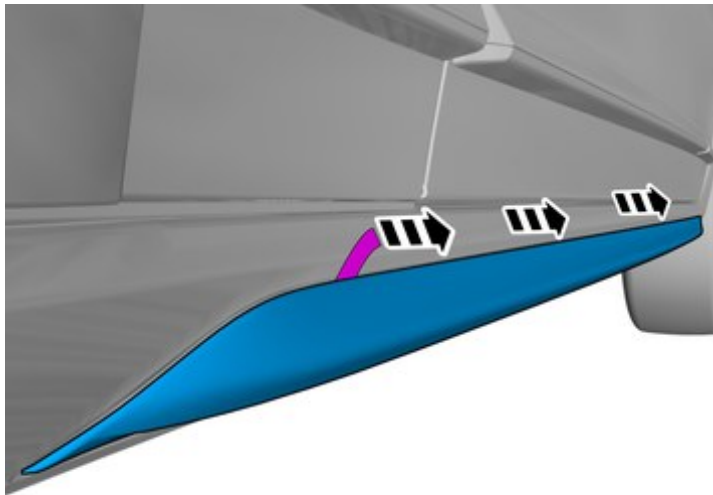

IMG-420695

**Caution!**

Pull carefully.

**Note!**

This step is easier with two people.

Remove the protective film.

# Installation instructions, accessories

Volvo Car Corporation Gothenburg, Sweden

12

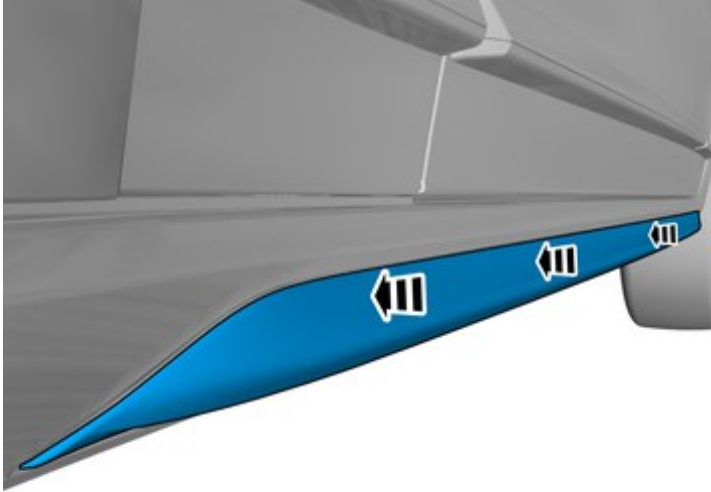

IMG-421560

**Note!**

Press and apply pressure to the part over the tape for at least 20 seconds.

13

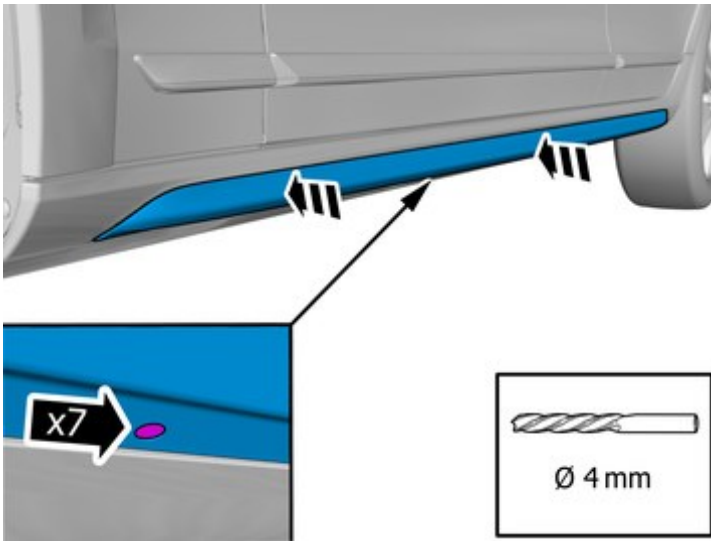

IMG-423145

Press the marked component.

Use a drill with the stated size



# Installation instructions, accessories

Volvo Car Corporation Gothenburg, Sweden

14

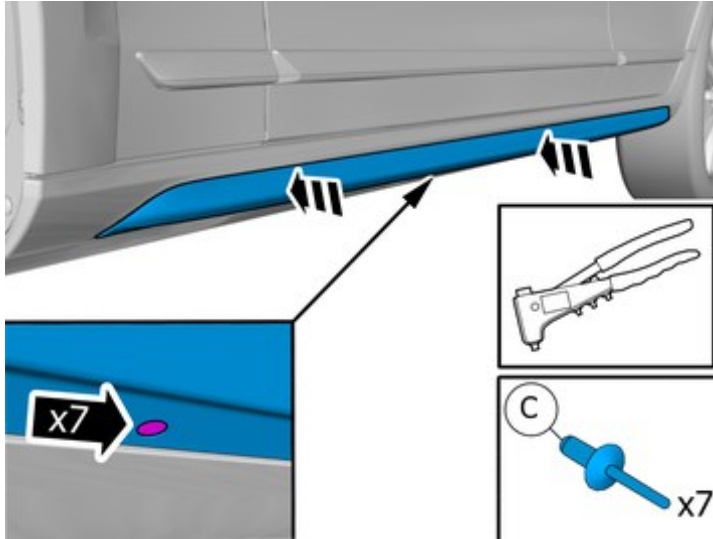

IMG-420696

Install component that comes with the accessory kit.

15

Repeat the steps when installing accessories on opposite side.