

Installation instructions, accessories

Volvo Car Corporation Gothenburg, Sweden

Instruction No 31339917 **Version** 1.0 **Part. No.** 31339913, 31399477

End pipes, double



IMG-355756

Equipment

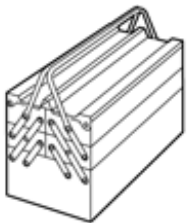

IMG-345497



IMG-244944



IMG-239981



IMG-239664

Nm
lbf.ft

Installation instructions, accessories

Volvo Car Corporation Gothenburg, Sweden

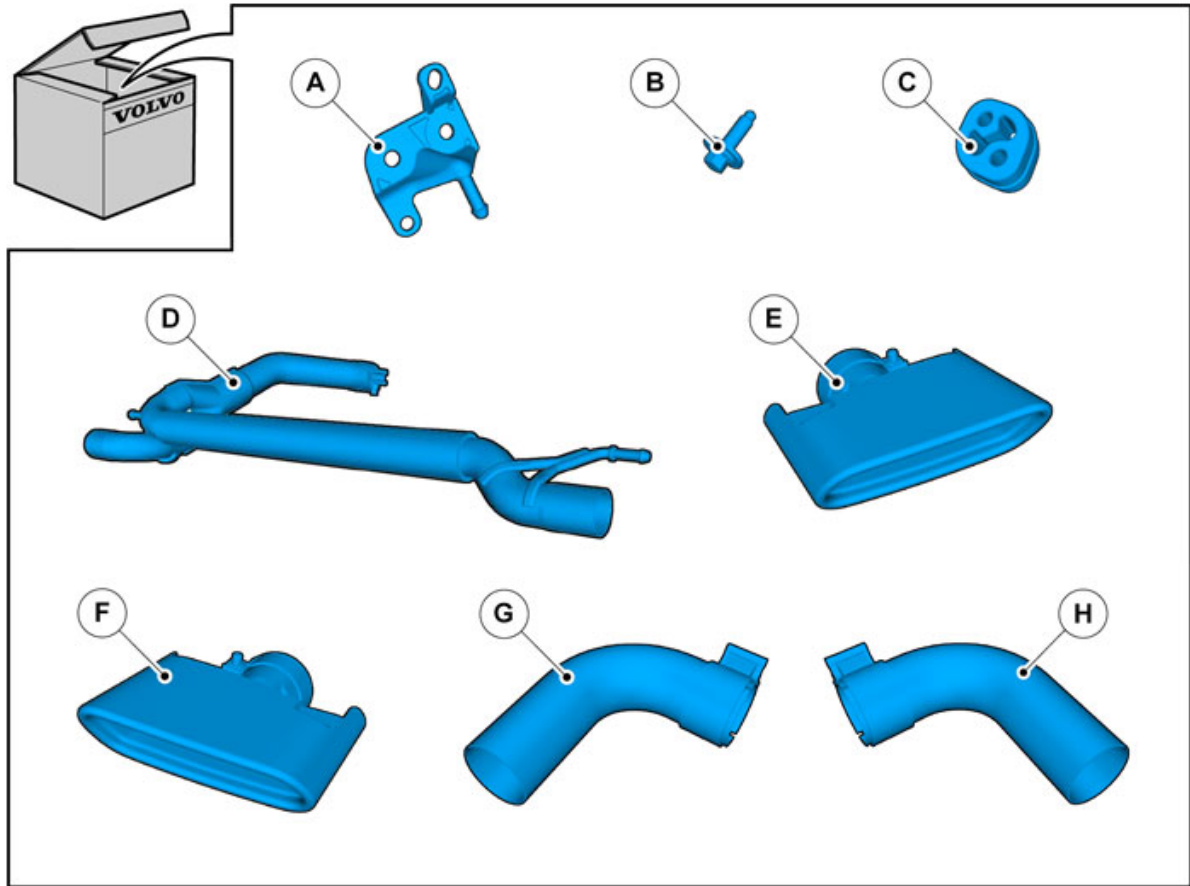

IMG-357492

Installation instructions, accessories

Volvo Car Corporation Gothenburg, Sweden

Information

1

Read through all of the instructions before starting installation.

Notifications and warning texts are for your safety and to minimise the risk of something breaking during installation.

Ensure that all tools stated in the instructions are available before starting installation.

Certain steps in the instructions are only presented in the form of images. Explanatory text is also given for more complicated steps.

In the event of any problems with the instructions or the accessory, contact your local Volvo dealer.

Color symbols

2

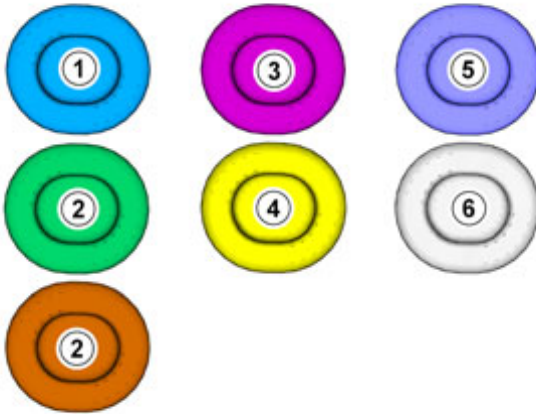

IMG-363036

Note!

This colour chart displays (in colour print and electronic version) the importance of the different colours used in the images of the method steps.

1. Used for focused component, the component with which you will do something.
 2. Used as extra colors when you need to show or differentiate additional parts.
 3. Used for attachments that are to be removed/installed. May be screws, clips, connectors, etc.
 4. Used when the component is not fully removed from the vehicle but only hung to the side.
 5. Used for standard tools and special tools.
 6. Used as background color for vehicle components.
-

Removal

Installation instructions, accessories

Volvo Car Corporation Gothenburg, Sweden

3

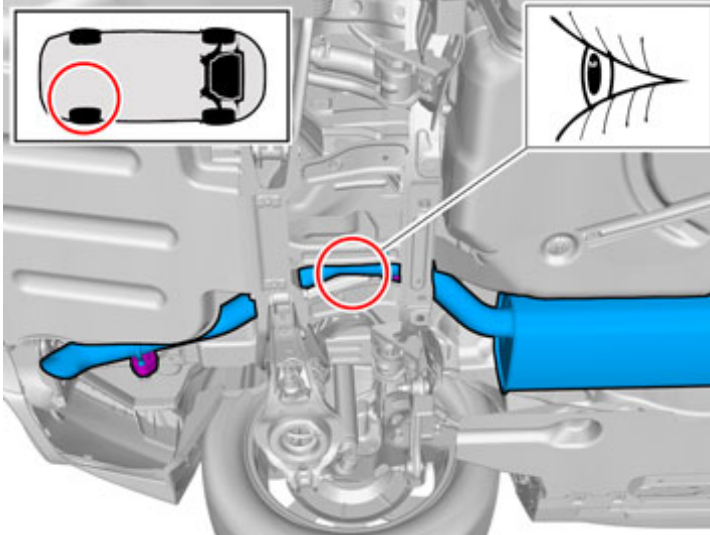

IMG-357842

4

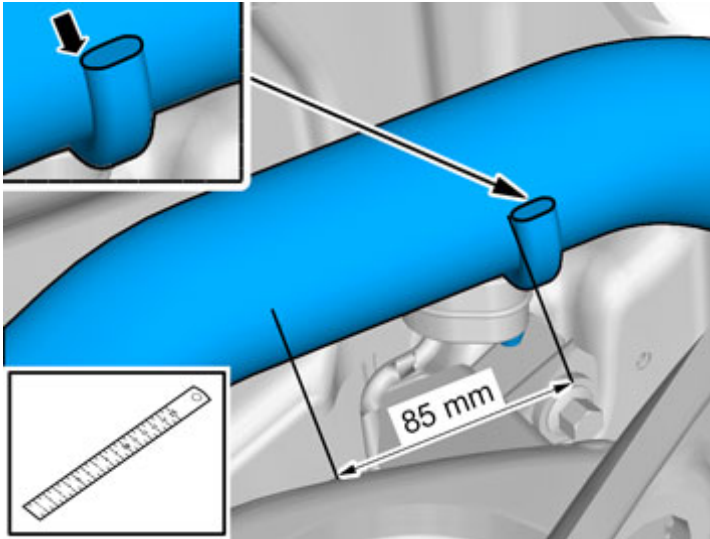

IMG-368166

Use: Scribe

Scribe/mark up

Installation instructions, accessories

Volvo Car Corporation Gothenburg, Sweden

5

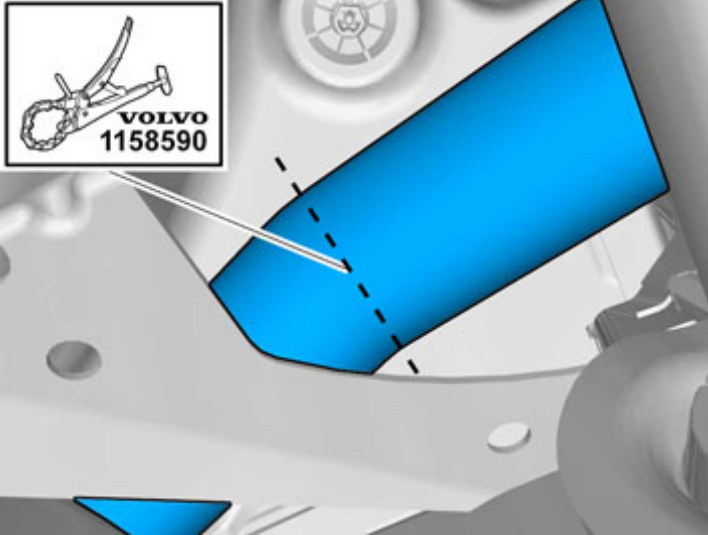

IMG-368167

Use: Pipe cutter

6

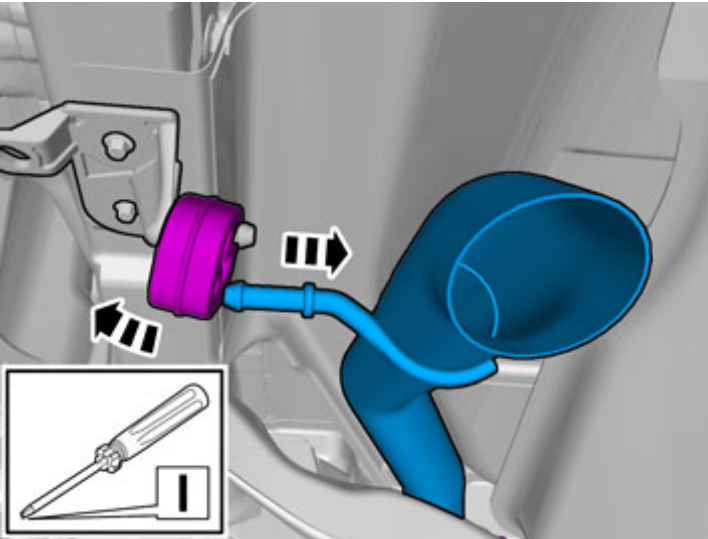

IMG-357534

Accessory installation

Installation instructions, accessories

Volvo Car Corporation Gothenburg, Sweden

7

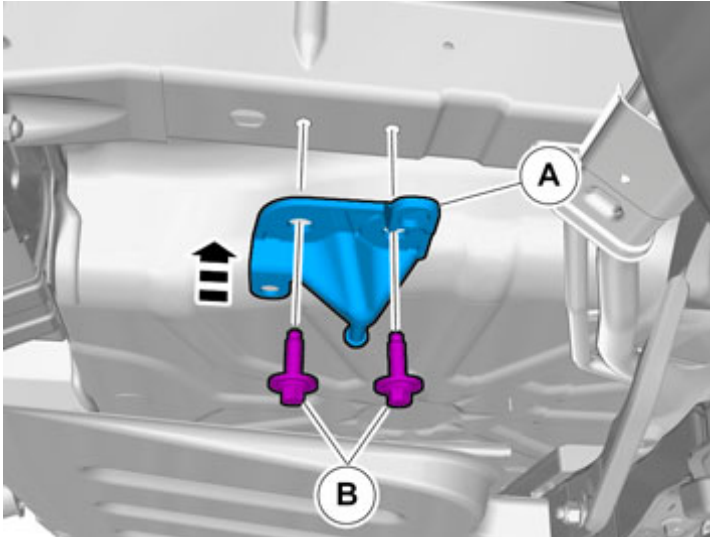

IMG-357541

8

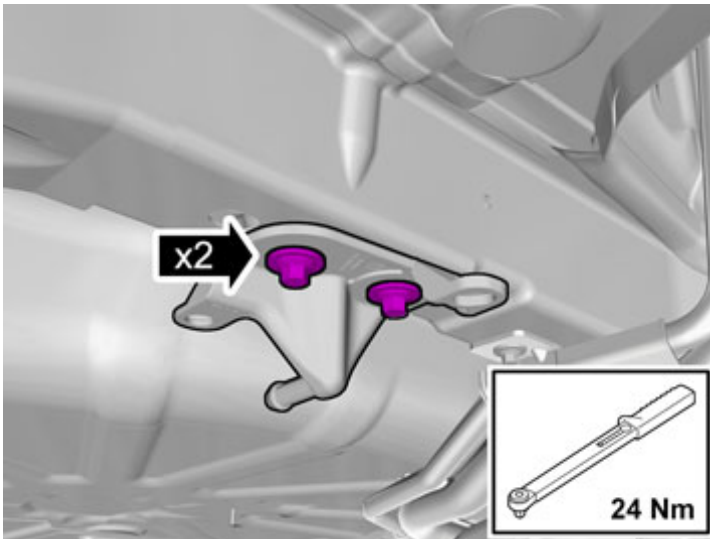

IMG-357576

Install the screws.

Tightening torque: M8 , 24 Nm

Installation instructions, accessories

Volvo Car Corporation Gothenburg, Sweden

9

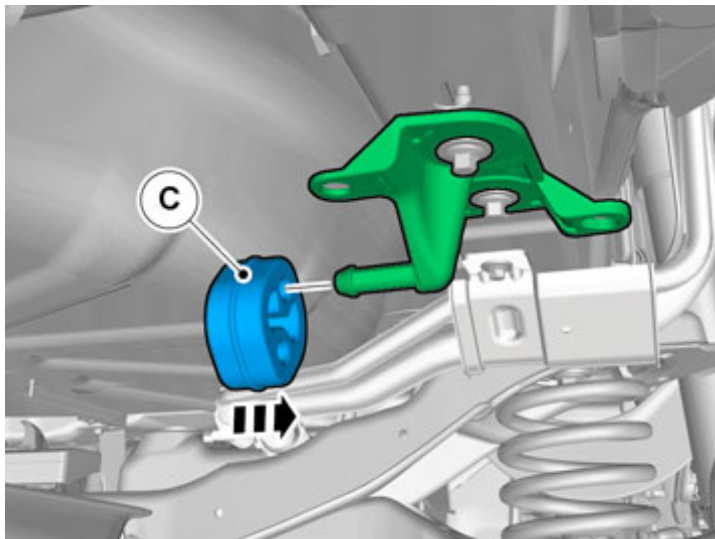

IMG-357577

10

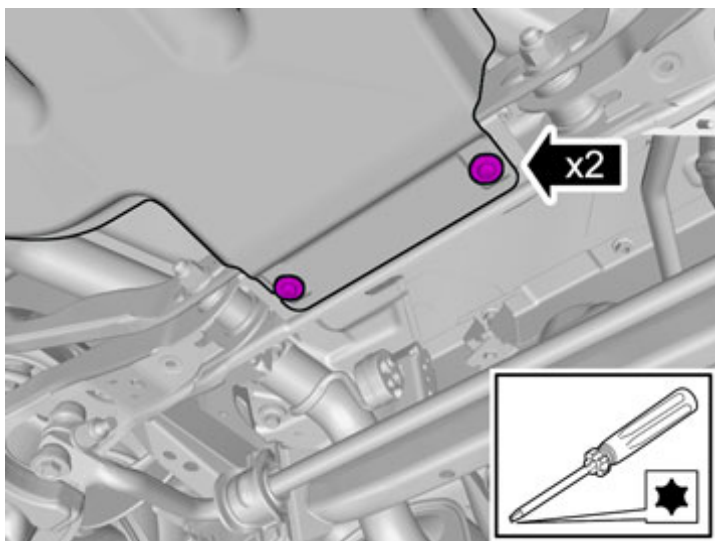

IMG-357498

Remove the screws.

Installation instructions, accessories

Volvo Car Corporation Gothenburg, Sweden

11

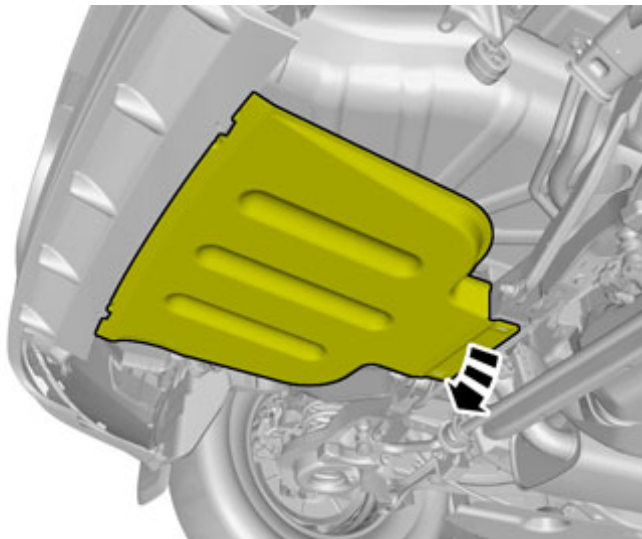

IMG-357586

12

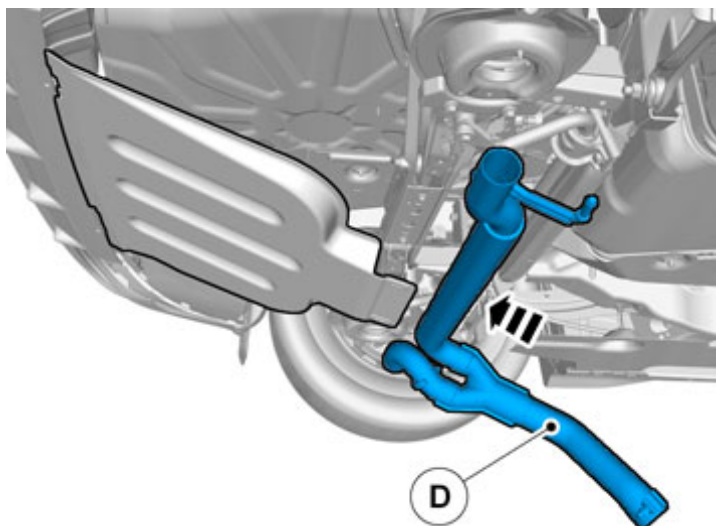

IMG-357589

Installation instructions, accessories

Volvo Car Corporation Gothenburg, Sweden

13

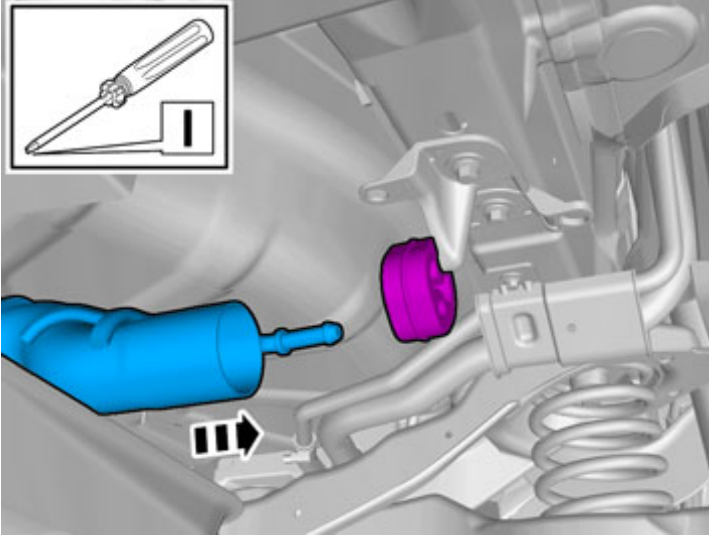

IMG-357591

14

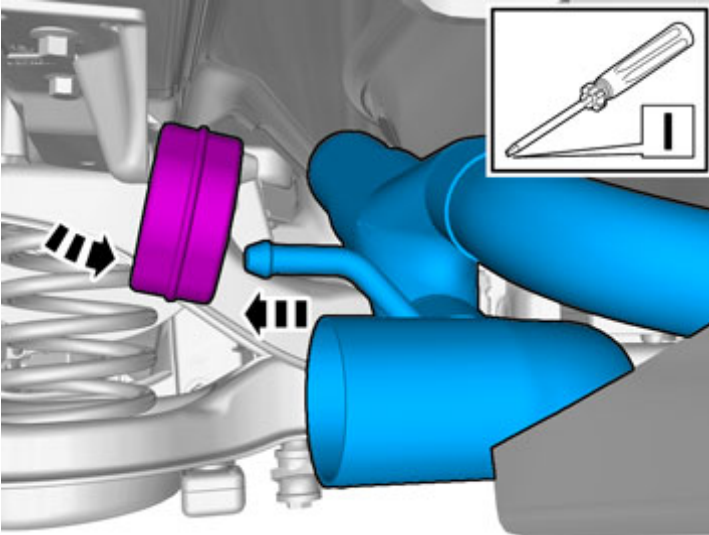

IMG-357592

Installation instructions, accessories

Volvo Car Corporation Gothenburg, Sweden

15

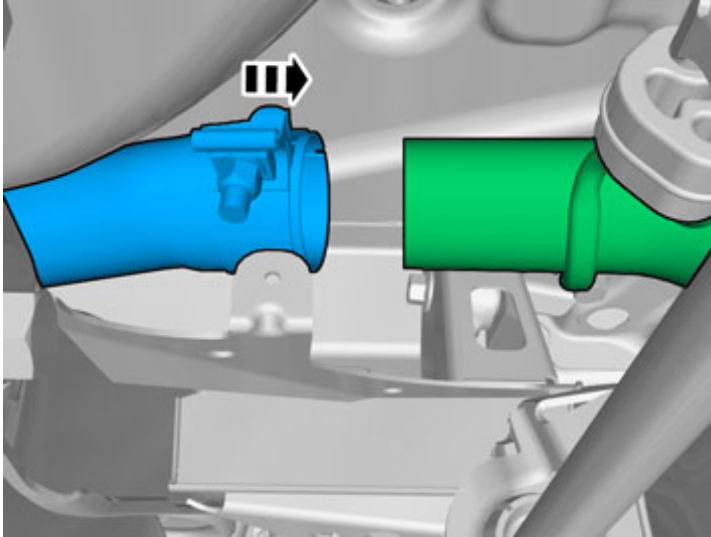

IMG-357600

16

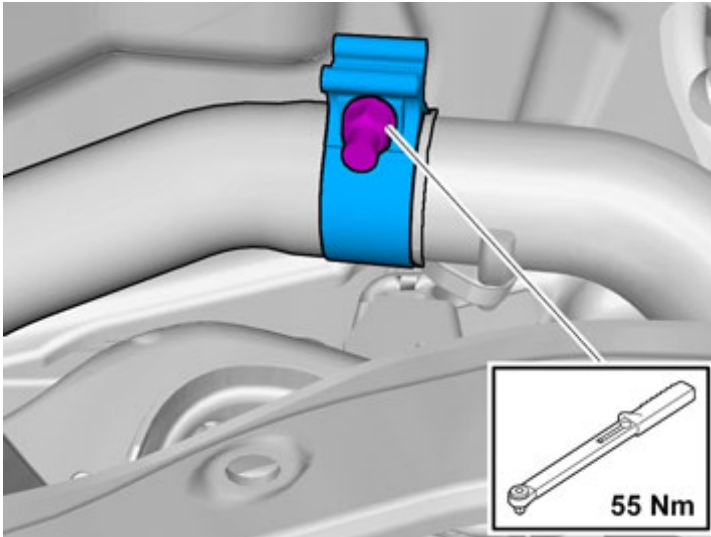

IMG-357853

Tighten the nut.

Installation instructions, accessories

Volvo Car Corporation Gothenburg, Sweden

17

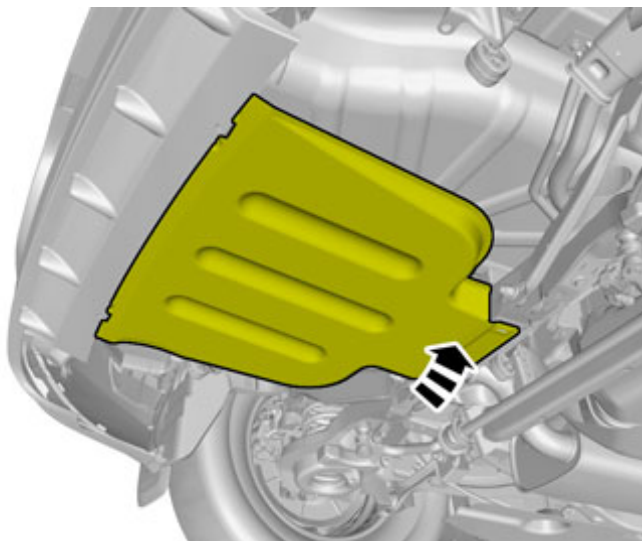

IMG-357691

18

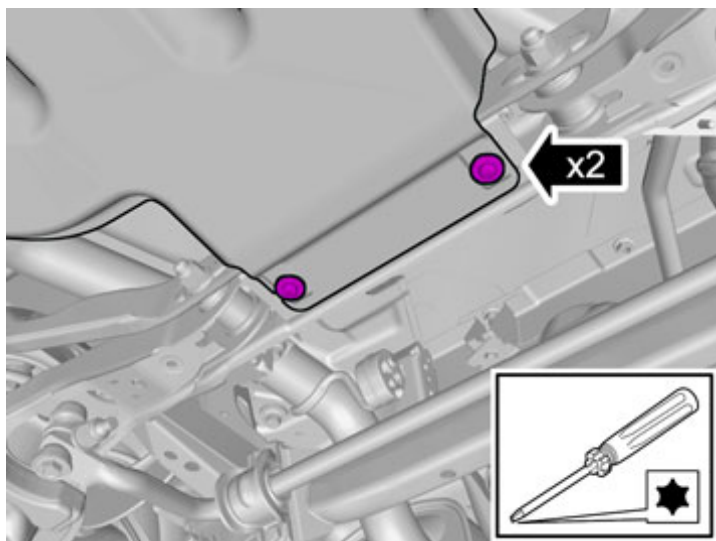

IMG-357498

Install the screws.

Applies to the left-hand side:

Installation instructions, accessories

Volvo Car Corporation Gothenburg, Sweden

19

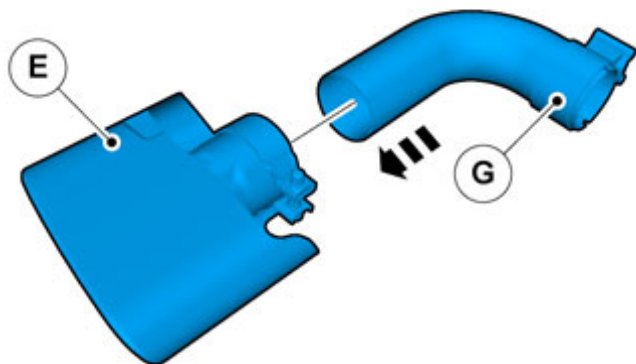

IMG-368168

20

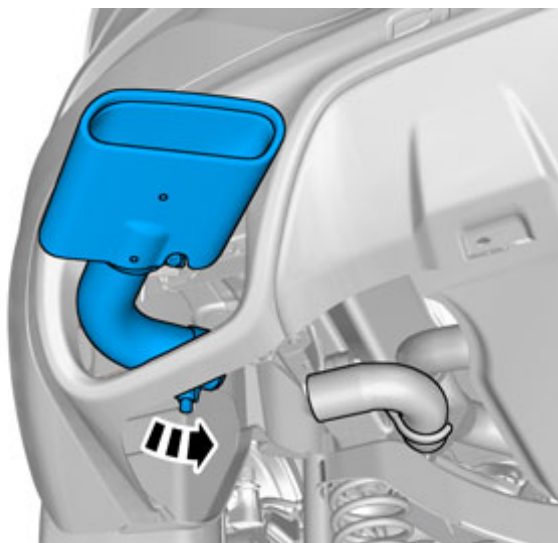

IMG-357864

Caution!
Make sure not to damage painted surfaces.

Installation instructions, accessories

Volvo Car Corporation Gothenburg, Sweden

21

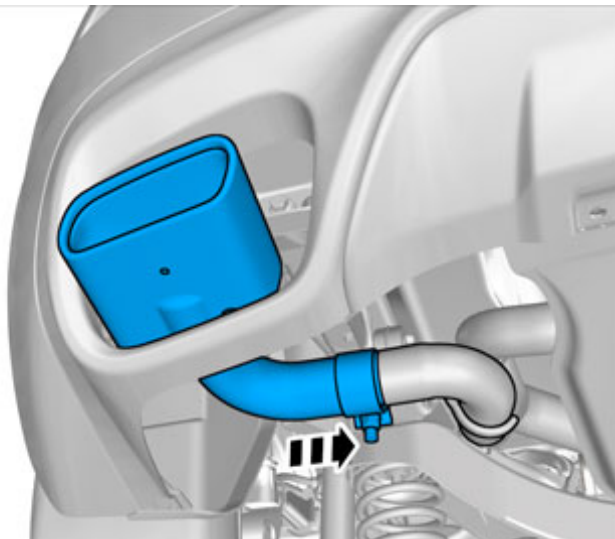

IMG-357866

22

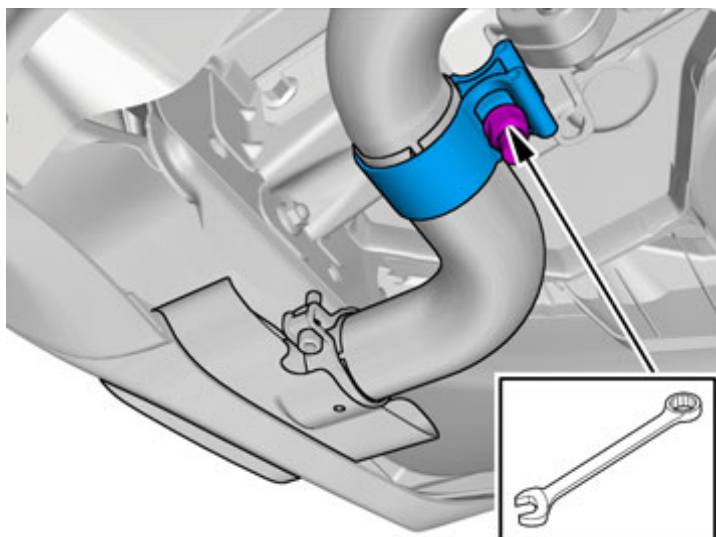

IMG-357871

Note!
Do not fully tighten the nut yet.

Installation instructions, accessories

Volvo Car Corporation Gothenburg, Sweden

23



IMG-357876

24

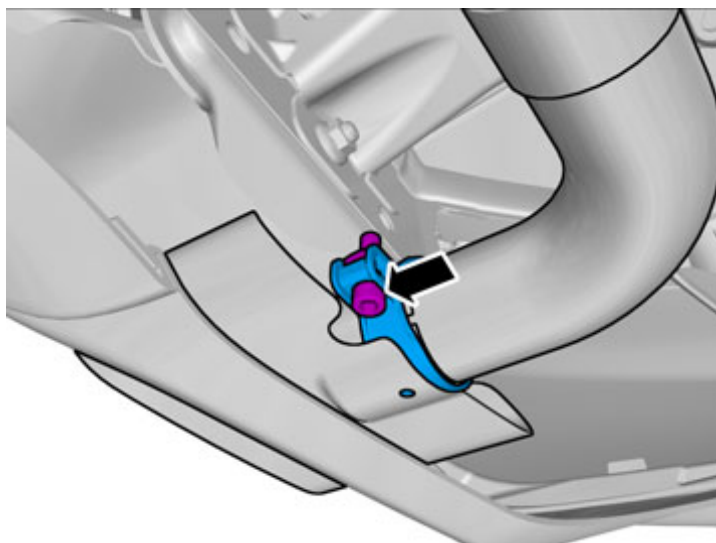

IMG-371885

Note!
Only tighten the bolt finger tight at this stage.

Installation instructions, accessories

Volvo Car Corporation Gothenburg, Sweden

25

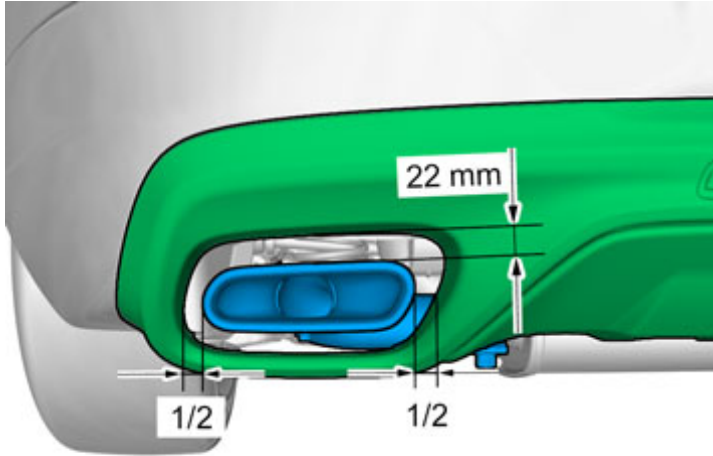

IMG-355817

26

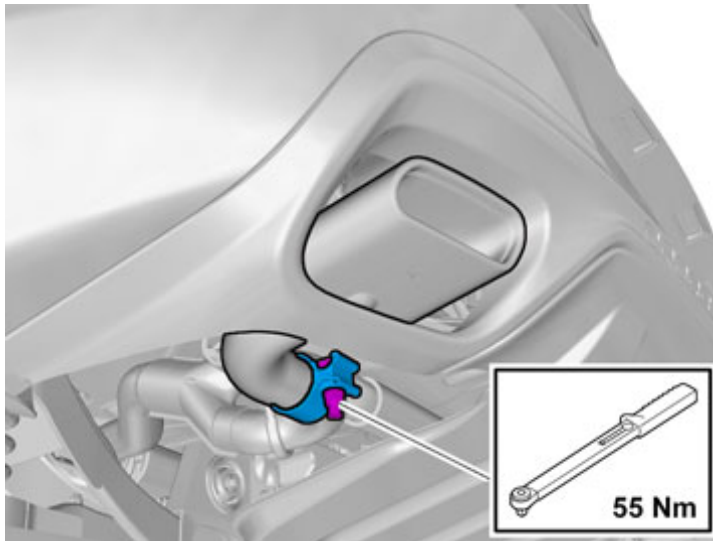

Tighten the nut.

IMG-357877

Installation instructions, accessories

Volvo Car Corporation Gothenburg, Sweden

27

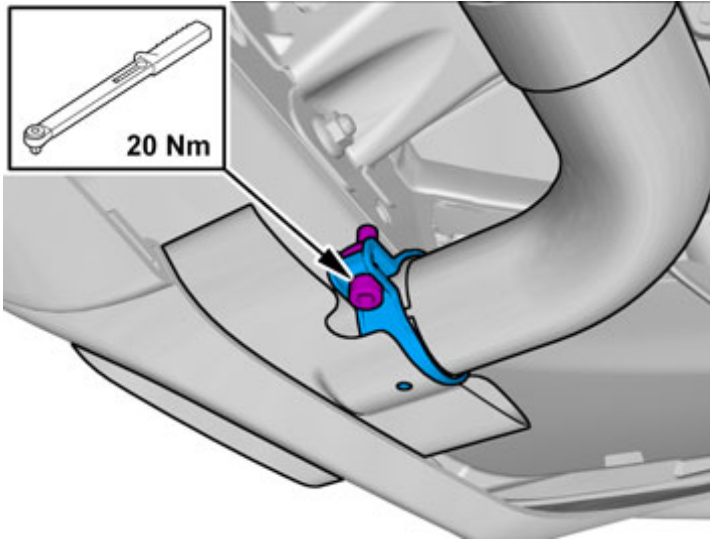

IMG-357878

Tighten the screw.

Applies to the right-hand side

28

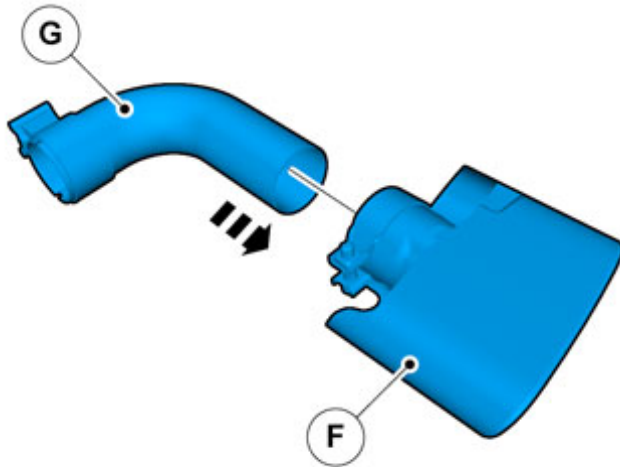

IMG-368172

Installation instructions, accessories

Volvo Car Corporation Gothenburg, Sweden

29

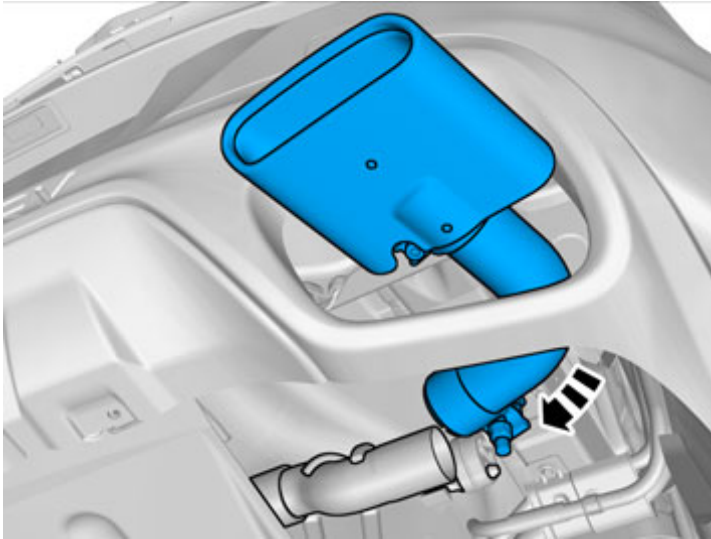

IMG-357906

30

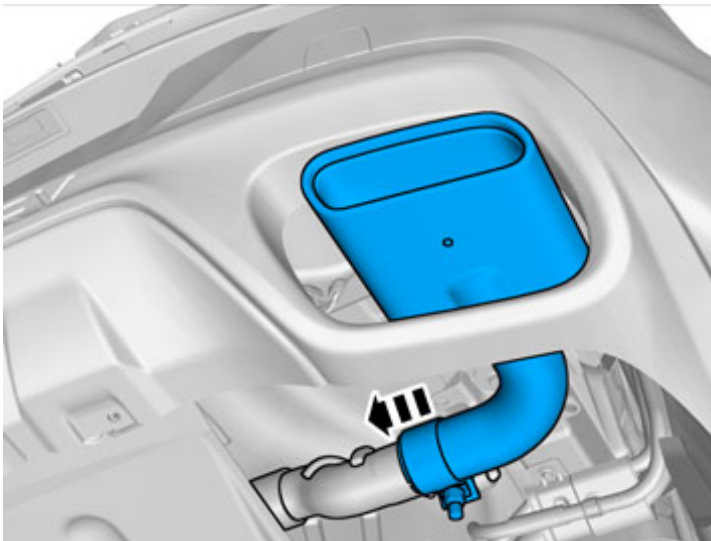

IMG-357880

Installation instructions, accessories

Volvo Car Corporation Gothenburg, Sweden

31

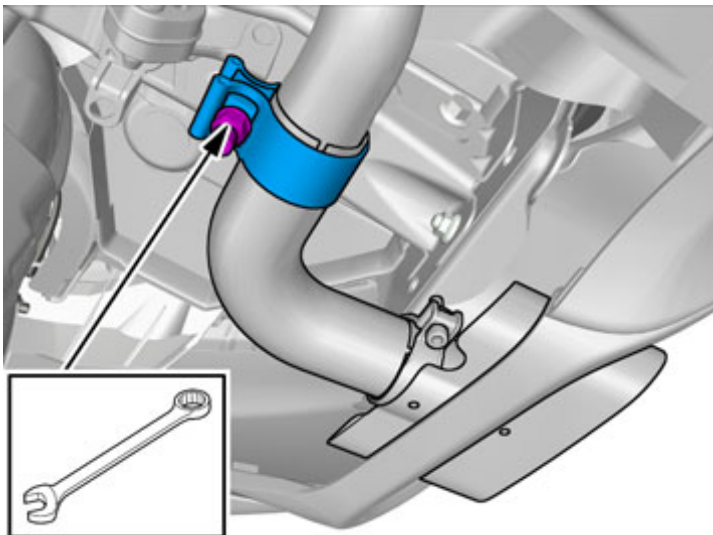

IMG-357881

Note!

Do not fully tighten the nut yet.

32



IMG-357911

Installation instructions, accessories

Volvo Car Corporation Gothenburg, Sweden

33

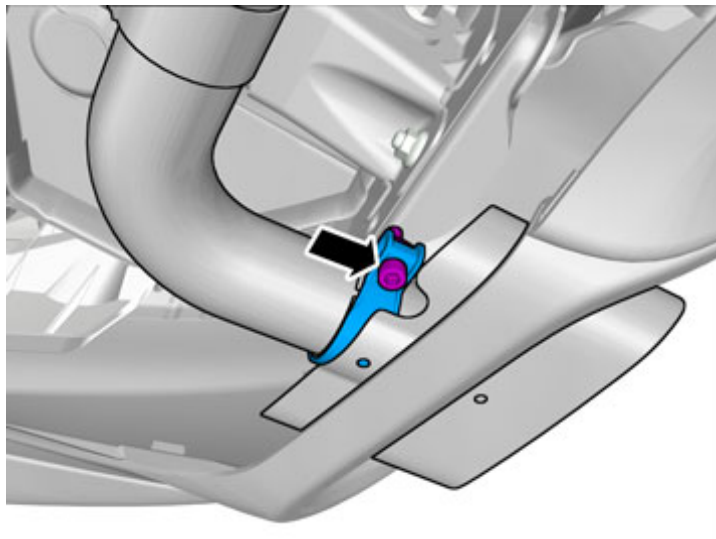

IMG-371896

Note!

Only tighten the bolt finger tight at this stage.

34

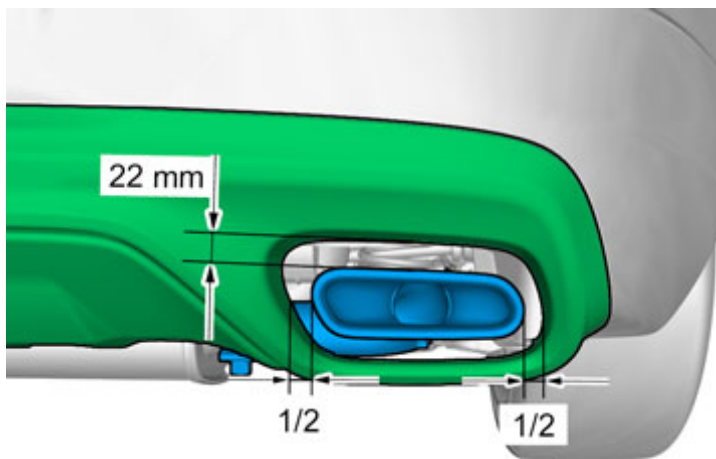

IMG-357912

Installation instructions, accessories

Volvo Car Corporation Gothenburg, Sweden

35

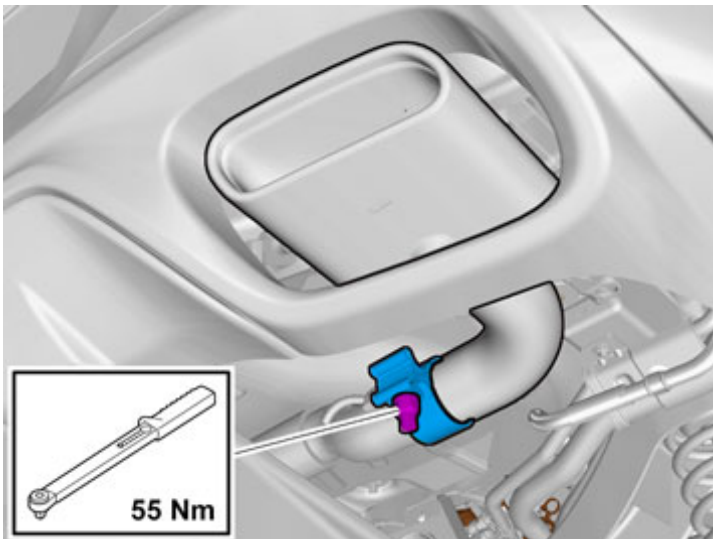

IMG-357913

Tighten the nut.

36

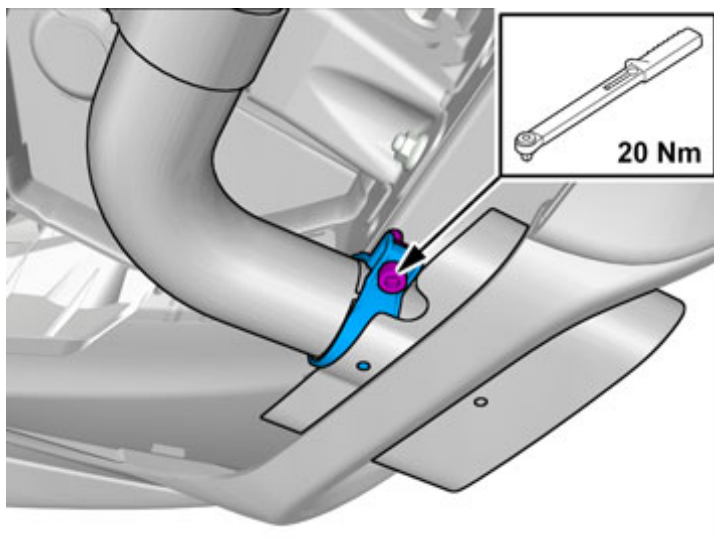

IMG-357917

Tighten the screw.