

Installation instructions, accessories

Volvo Car Corporation Gothenburg, Sweden

Instruction No	Version	Part. No.
31316894	1.2	39831883, 39831944, 39834285, 39831890, 39831889, 39831888, 39831877, 39831886, 39831881, 39831887, 39831880, 39835462, 39831885, 39831884, 39831878, 39831882, 39831876, 31414648, 39831879, 39822311, 39818935, 39822312, 39822313, 39822314, 39822315, 39818933, 39814304, 39813692, 39813695, 39814295, 39814298, 39814301, 39814307, 39814310, 39814313, 39814316, 39817153, 39818931, 39822310, 39823006

Spoiler, roof



IMG-354951

Equipment

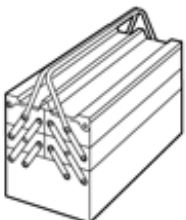

IMG-345497

Installation instructions, accessories

Volvo Car Corporation Gothenburg, Sweden

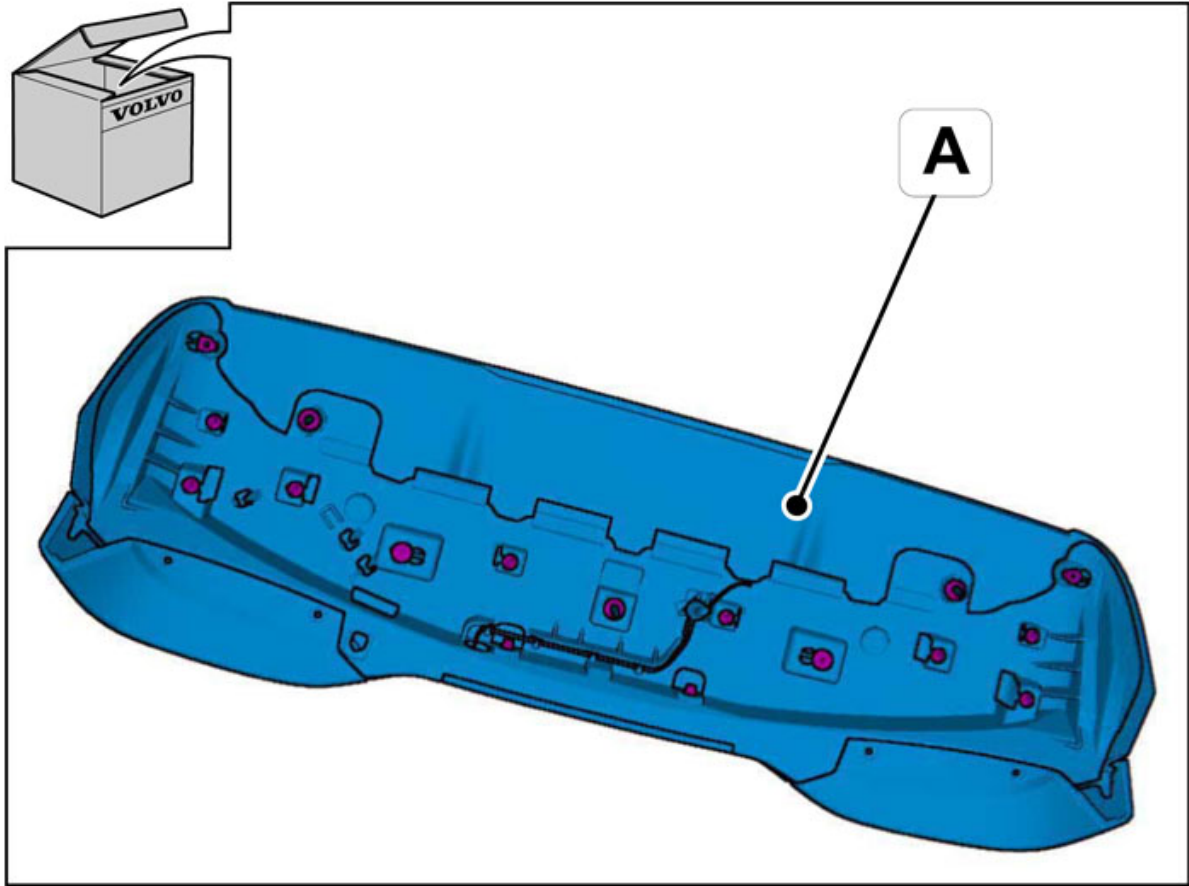

IMG-355002

Installation instructions, accessories

Volvo Car Corporation Gothenburg, Sweden

Information

1

Read through all of the instructions before starting installation.

Notifications and warning texts are for your safety and to minimise the risk of something breaking during installation.

Ensure that all tools stated in the instructions are available before starting installation.

Certain steps in the instructions are only presented in the form of images. Explanatory text is also given for more complicated steps.

In the event of any problems with the instructions or the accessory, contact your local Volvo dealer.

Color symbols

2

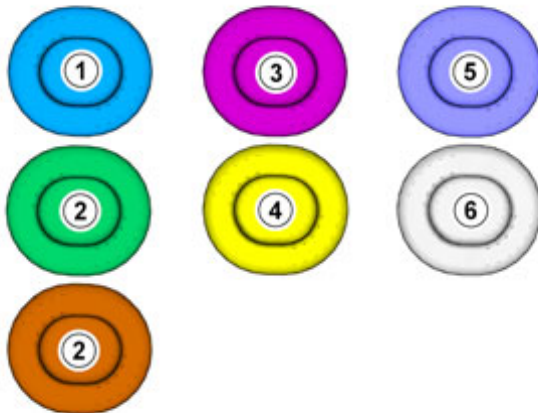

IMG-363036

Note!

This colour chart displays (in colour print and electronic version) the importance of the different colours used in the images of the method steps.

1. Used for focused component, the component with which you will do something.
 2. Used as extra colors when you need to show or differentiate additional parts.
 3. Used for attachments that are to be removed/installed. May be screws, clips, connectors, etc.
 4. Used when the component is not fully removed from the vehicle but only hung to the side.
 5. Used for standard tools and special tools.
 6. Used as background color for vehicle components.
-

Removal

Installation instructions, accessories

Volvo Car Corporation Gothenburg, Sweden

3

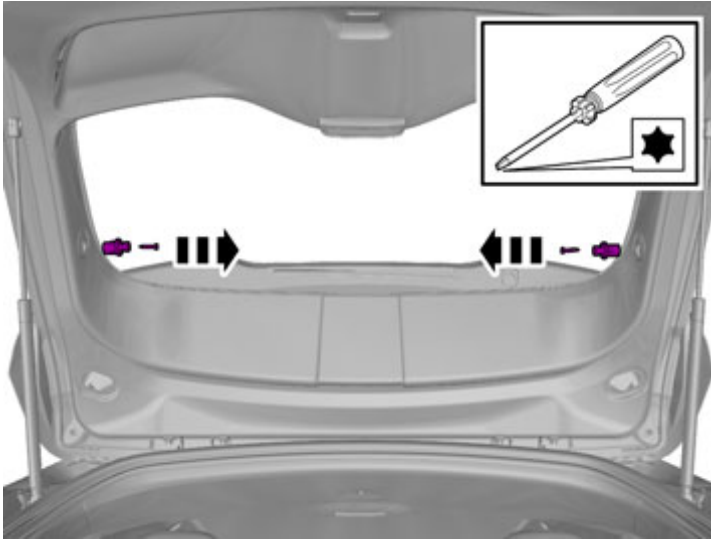

Remove the screws.

4

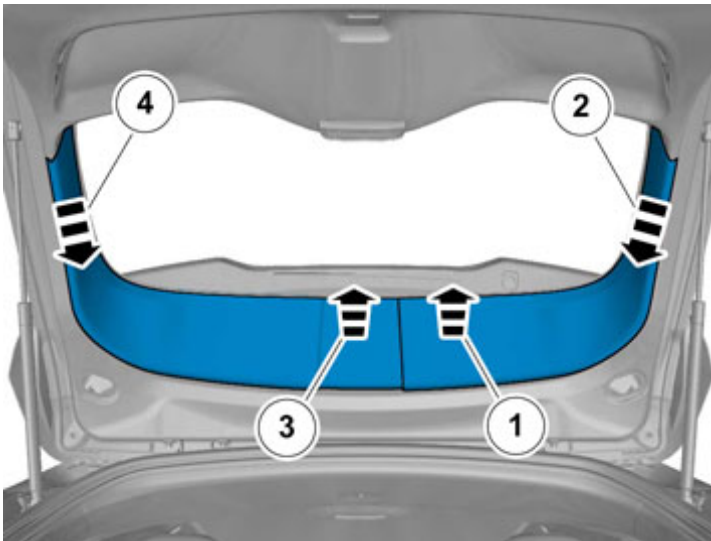

Installation instructions, accessories

Volvo Car Corporation Gothenburg, Sweden

5

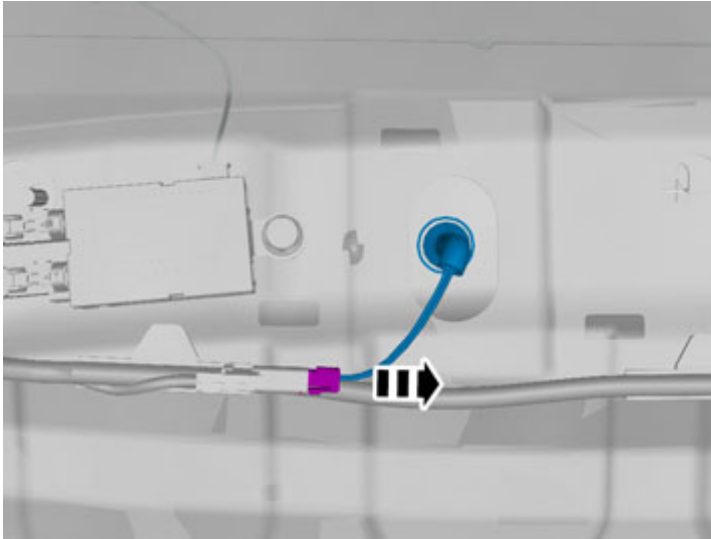

IMG-354959

Disconnect the connector.

6

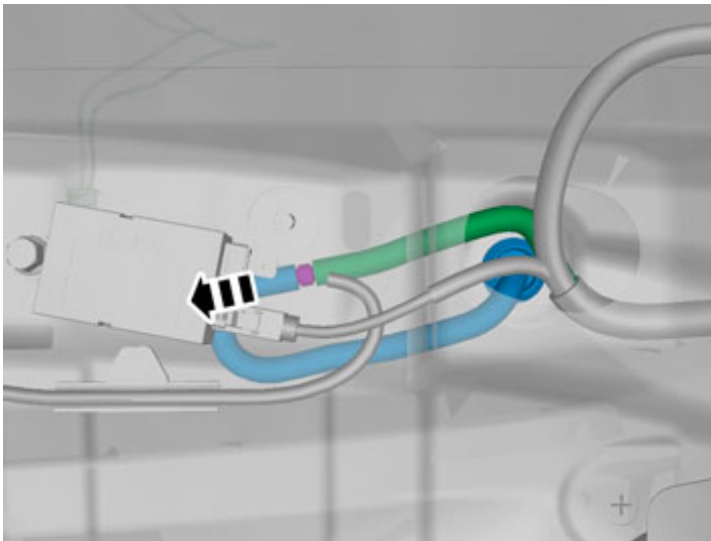

IMG-354960

Remove the hose.

Installation instructions, accessories

Volvo Car Corporation Gothenburg, Sweden

7

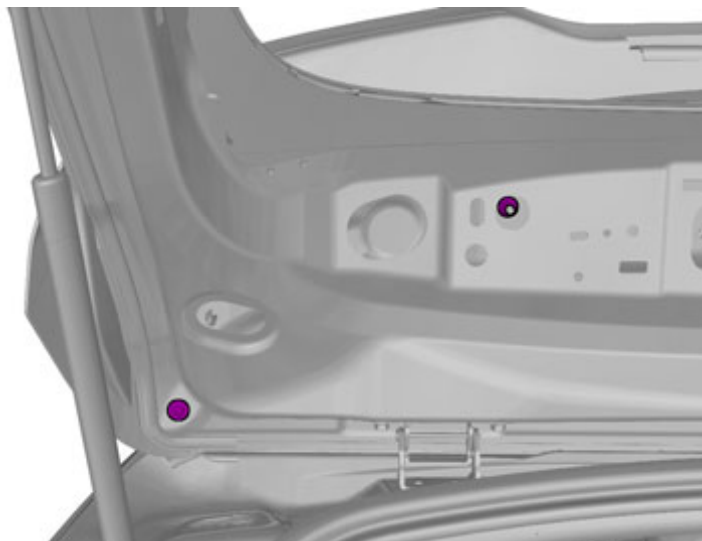

IMG-355001

On both sides.

8

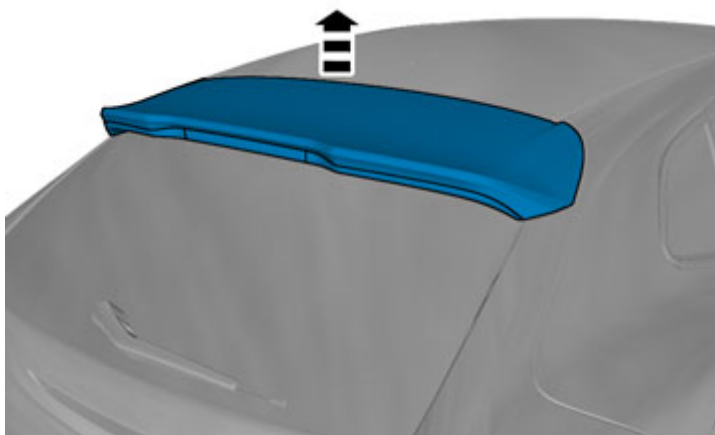

IMG-354961

Installation

Installation instructions, accessories

Volvo Car Corporation Gothenburg, Sweden

9

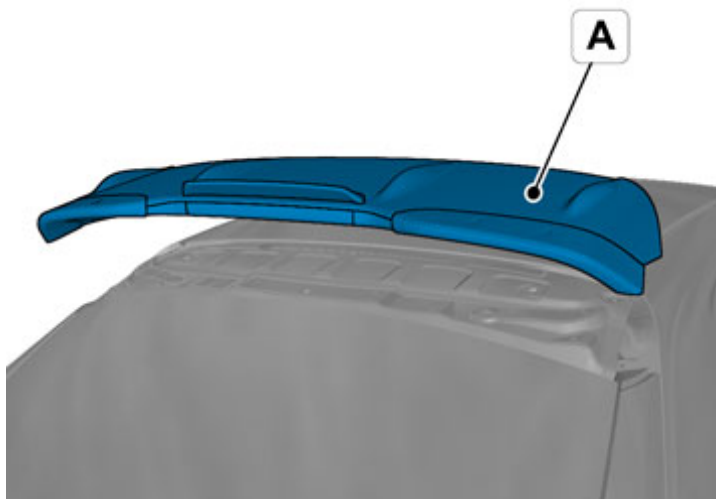

IMG-355028

10

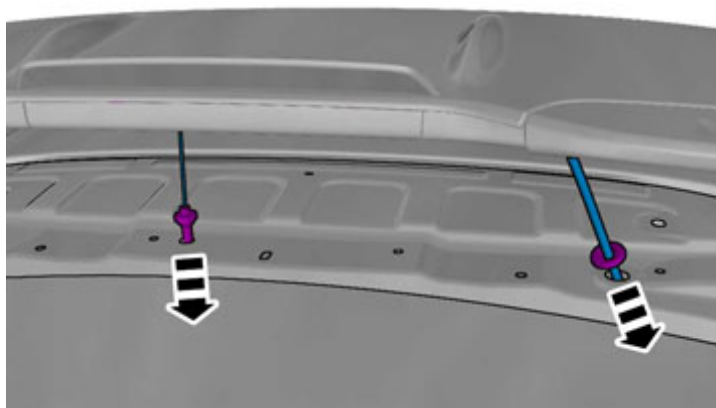

IMG-355023

Caution!

Make sure that the rubber grommet seals properly to the body.

Installation instructions, accessories

Volvo Car Corporation Gothenburg, Sweden

11

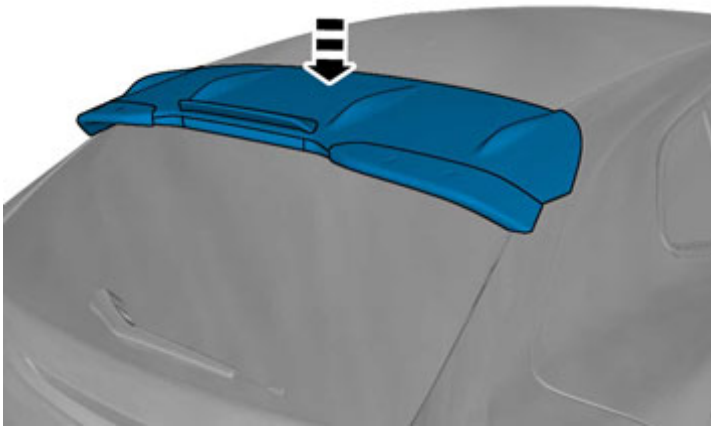

IMG-354962

12

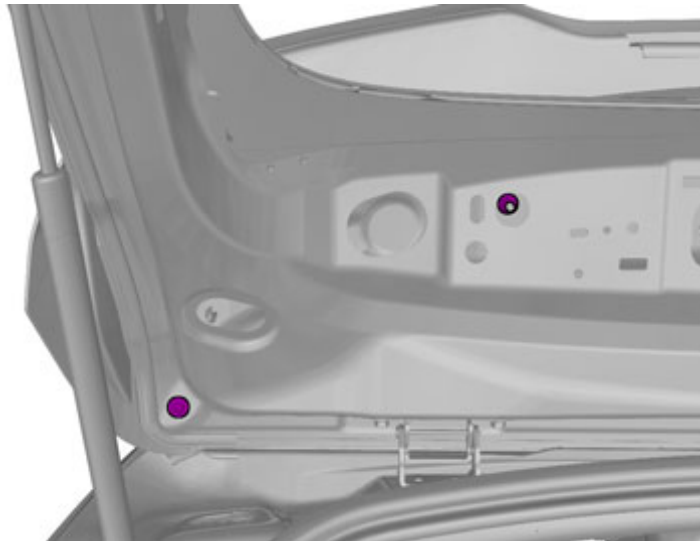

IMG-355001

On both sides.

Installation instructions, accessories

Volvo Car Corporation Gothenburg, Sweden

13

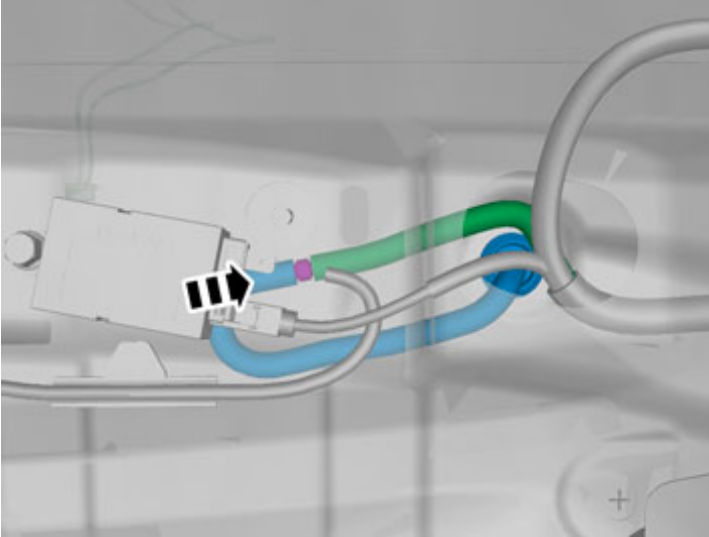

IMG-355032

Install the hose.

14

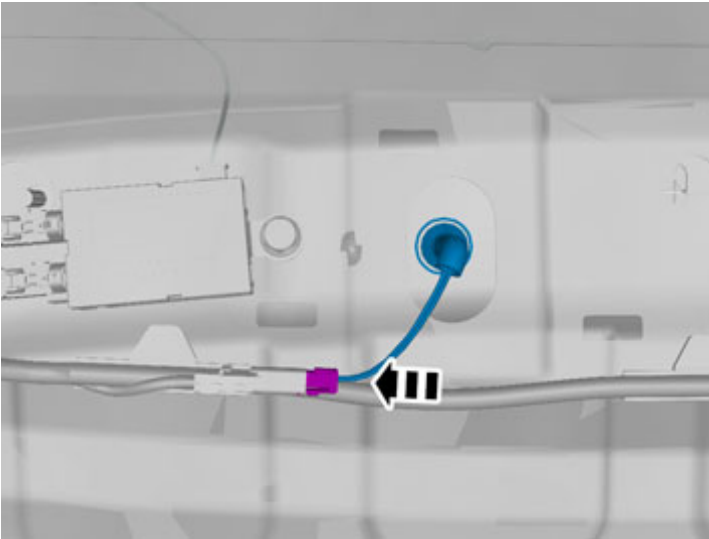

IMG-355031

Connect the connector.

Installation instructions, accessories

Volvo Car Corporation Gothenburg, Sweden

15

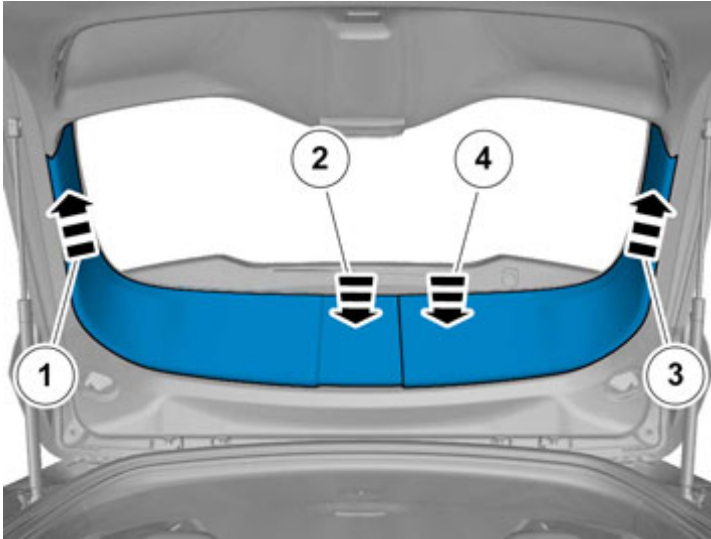

IMG-354973

16

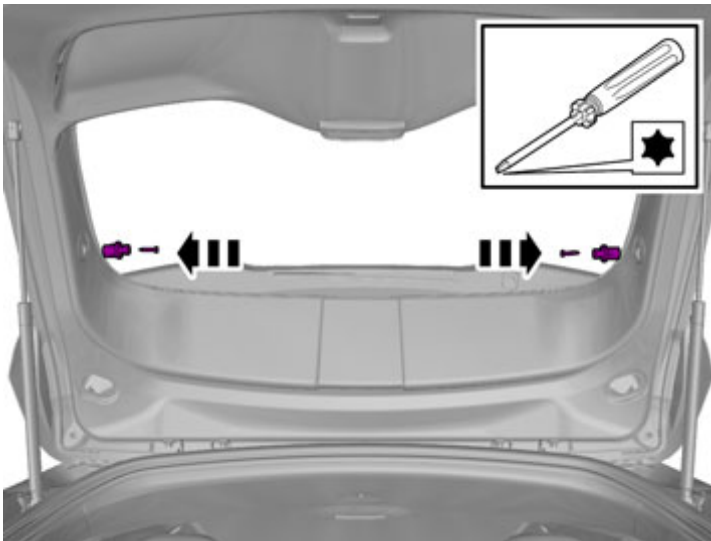

IMG-354972

Reinstall the screws.