

# Installation instructions, accessories

Volvo Car Corporation Gothenburg, Sweden

**Instruction No** 31265629    **Version** 1.1    **Part. No.** 31316074, 31316485, 31316484, 31265626, 31316075

## Skid plate, front bumper



IMG-339291

### Equipment

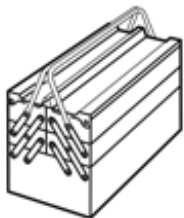

A0000162



IMG-239660



IMG-239681

2 h



A0000177

48h



A0000214

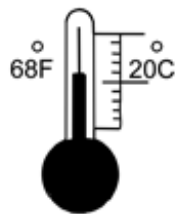

M0000232

# Installation instructions, accessories

Volvo Car Corporation Gothenburg, Sweden

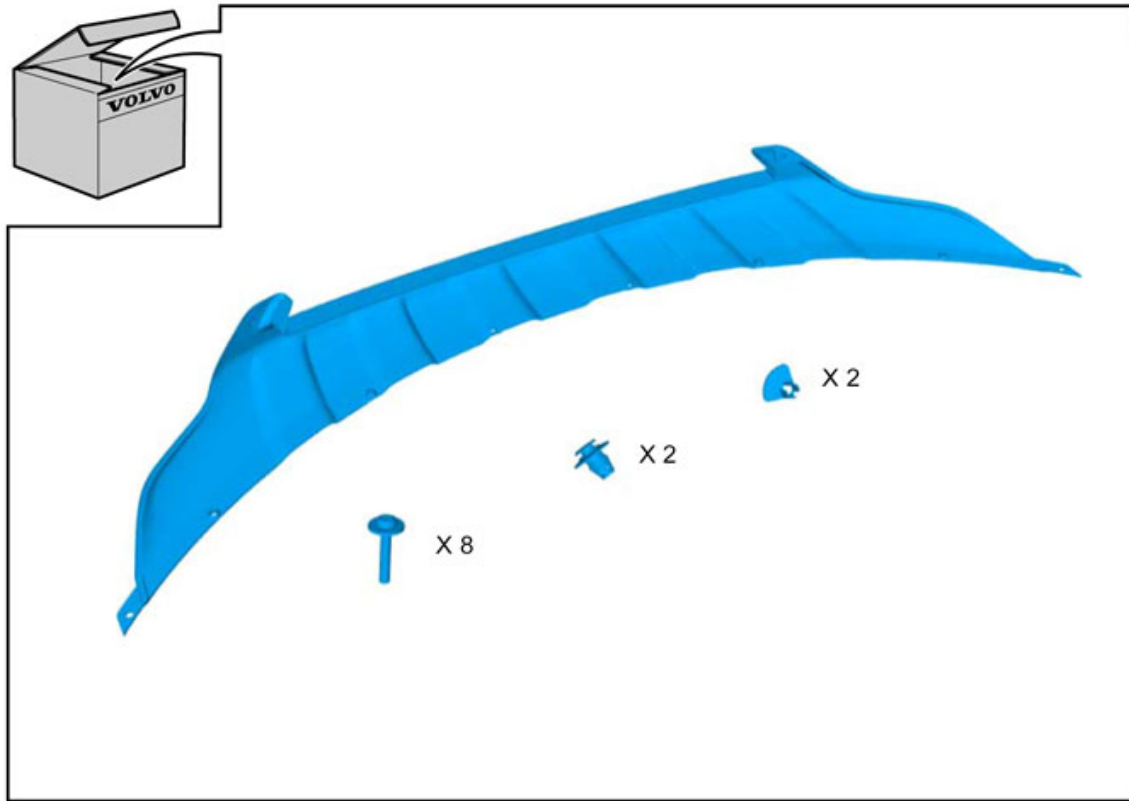

IMG-339292

# Installation instructions, accessories

Volvo Car Corporation Gothenburg, Sweden

## INTRODUCTION

Read through all of the instructions before starting installation.

Notifications and warning texts are for your safety and to minimise the risk of something breaking during installation.

Ensure that all tools stated in the instructions are available before starting installation.

Certain steps in the instructions are only presented in the form of images. Explanatory text is also given for more complicated steps.

In the event of any problems with the instructions or the accessory, contact your local Volvo dealer.

### Note!

Carry out the work at a temperature of at least 20 °C (68 °F).

Do not use the vehicle within 2 hours after doing the work.

Do not wash the vehicle within 48 hours after doing the work.

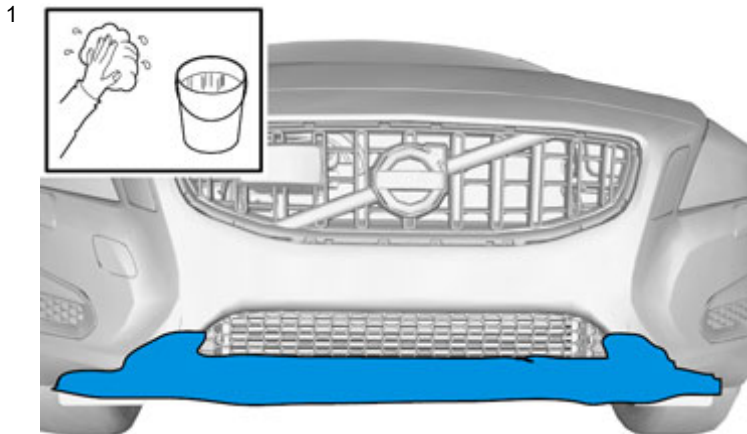

IMG-339288

Wash the surfaces of the car that are to be covered by the skid plate.

Wipe dry.

# Installation instructions, accessories

Volvo Car Corporation Gothenburg, Sweden

2

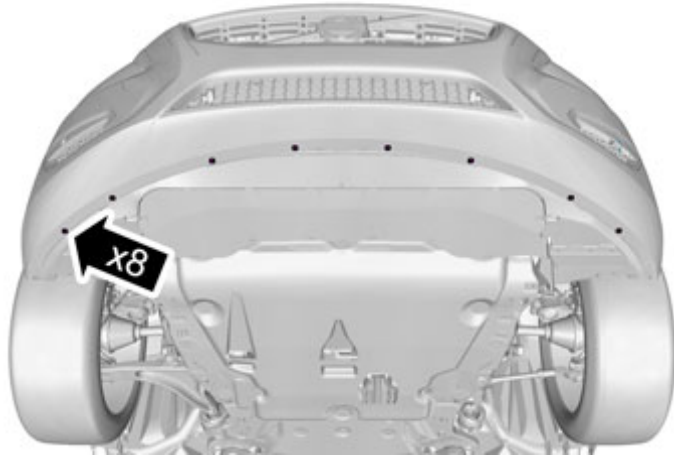

IMG-339289

Remove the screws and place to one side. New ones can be found in the kit.

3

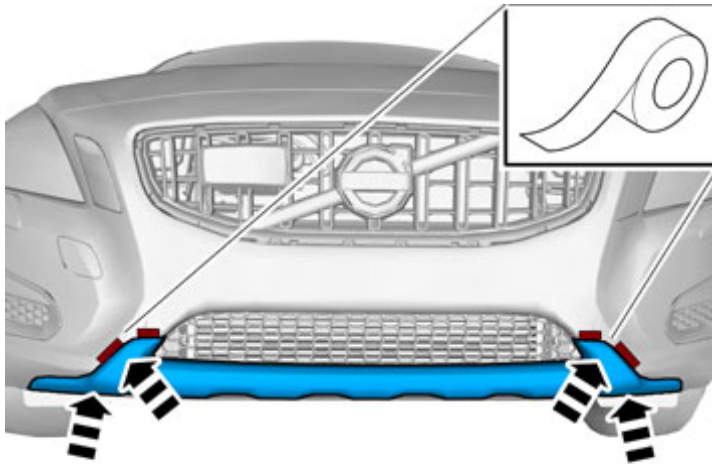

IMG-339290

Get help from a colleague for marking.

Place the skid plate in position as illustrated.

Press it from underneath and from the front towards the body as shown by the arrows.

Mark out the positions of the sides using pieces of tape.

Remove the skid plate.

# Installation instructions, accessories

Volvo Car Corporation Gothenburg, Sweden

4

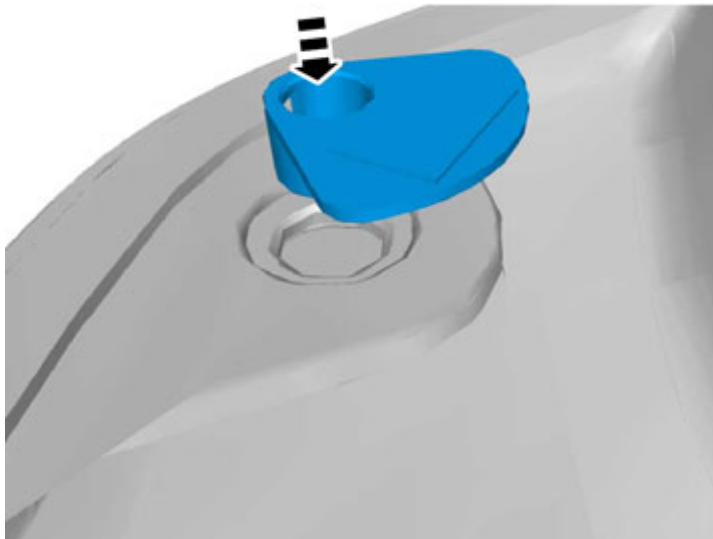

IMG-339275

Take the drilling templates from the kit and press the drilling templates into the holes in the skid plate on both sides.

5

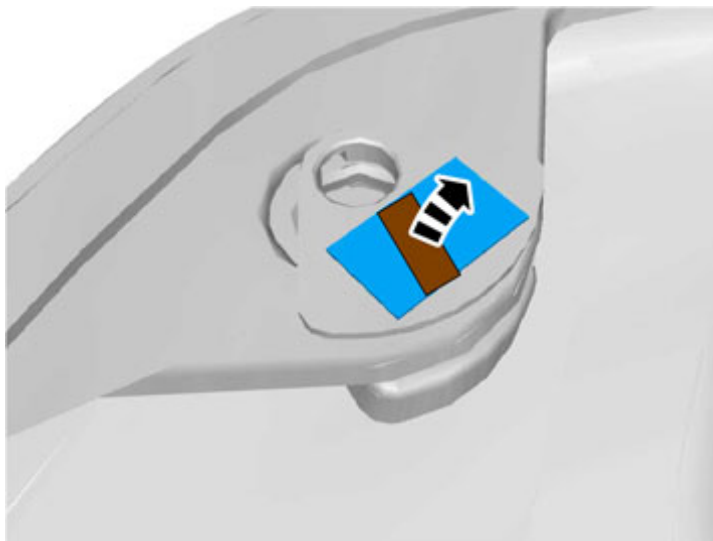

IMG-339274

Remove the backing tape from both templates.

# Installation instructions, accessories

Volvo Car Corporation Gothenburg, Sweden

6

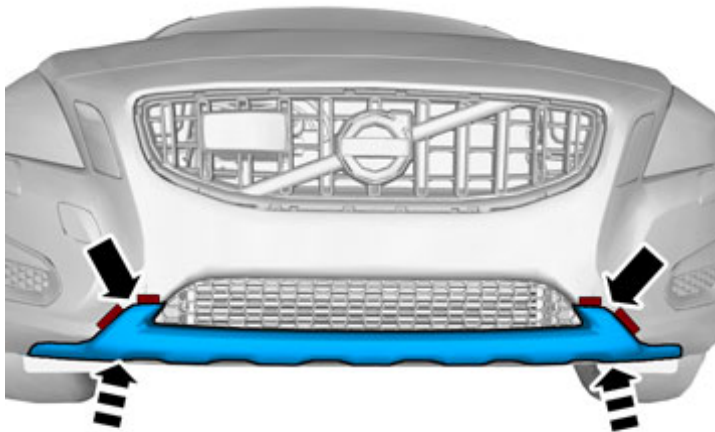

IMG-339287

Centre the skid plate according to the markings made and press it so that the drilling templates secure on the inside.

7

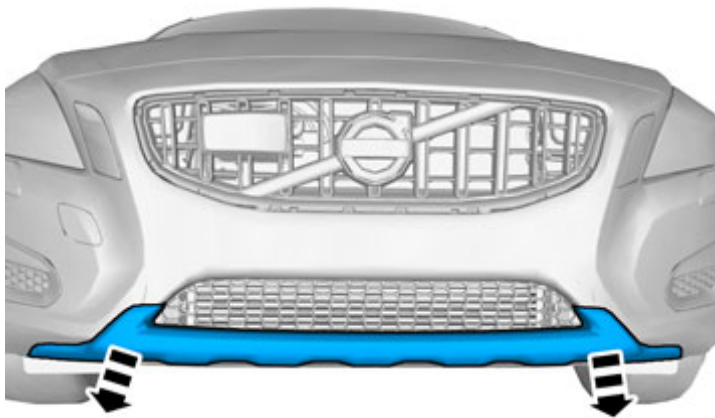

IMG-339280

Remove the skid plate from the grille.

Remove the tape markings.

# Installation instructions, accessories

Volvo Car Corporation Gothenburg, Sweden

8

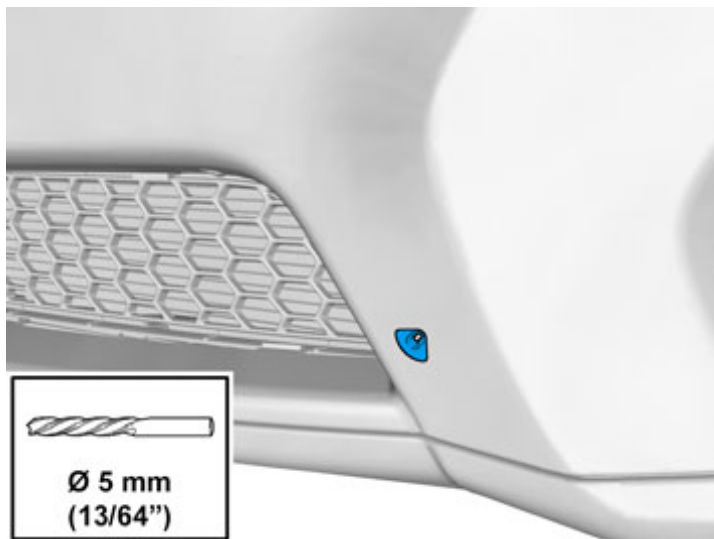

IMG-339279

Drill out the holes through the taped drilling templates.

9



IMG-339266

Remove the drilling templates and tape residue on both sides.

# Installation instructions, accessories

Volvo Car Corporation Gothenburg, Sweden

10

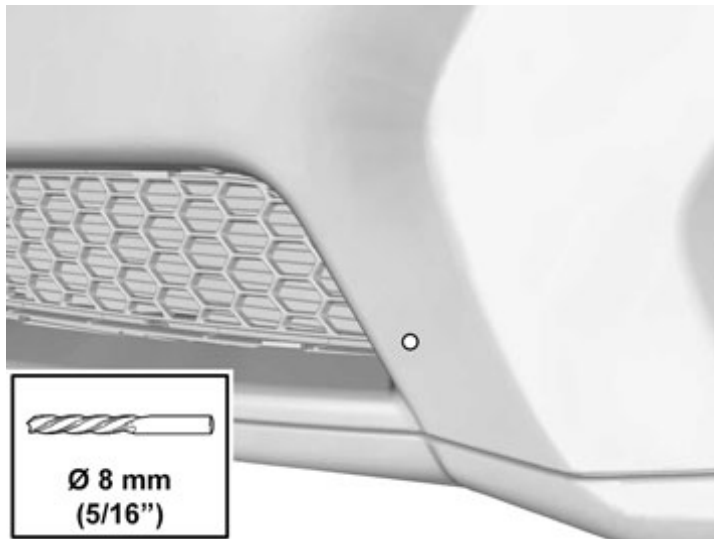

IMG-339276

Drill the holes to  $\text{Ø } 8 \text{ mm}$  (5/16").

Remove the swarf and smooth off the hole edges.

11

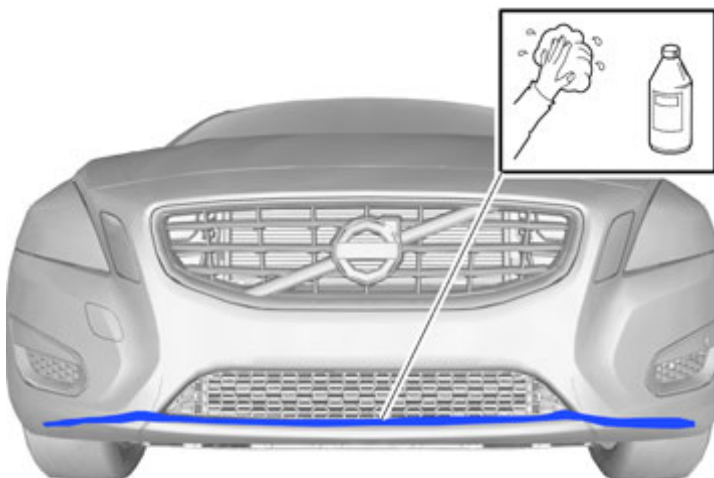

IMG-339281

Clean using isopropanol where the tape on the skid plate was secured. Wipe dry.



# Installation instructions, accessories

Volvo Car Corporation Gothenburg, Sweden

12

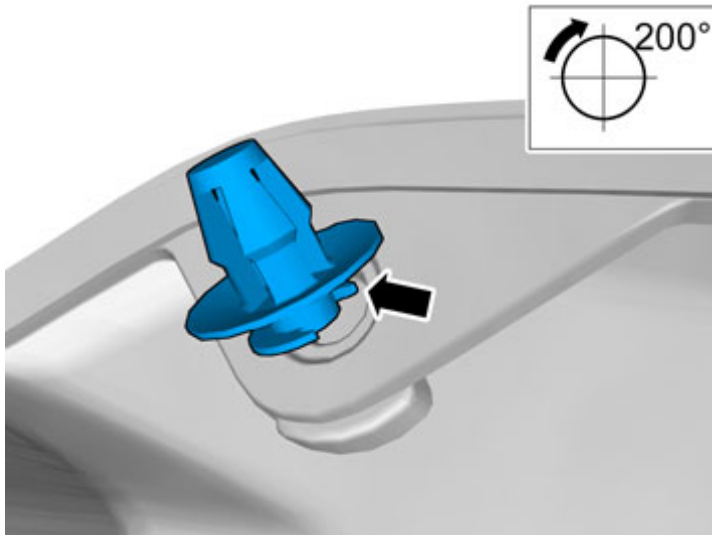

IMG-339282

Take the clip from the kit and take out the skid plate again.

Insert one spike on the clip under the edge of the hole in the skid plate, turn anticlockwise and at the same time press until the clip is in place.

Repeat the operation on the other side.

13

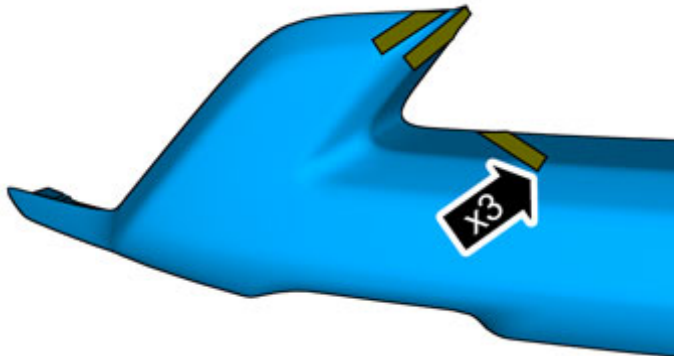

IMG-339283

Fold out the protective tape tabs on both sides.

# Installation instructions, accessories

Volvo Car Corporation Gothenburg, Sweden

14

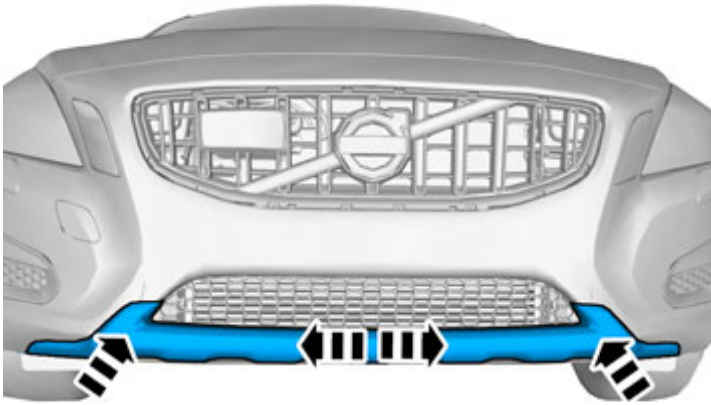

IMG-339293

## Note!

Ensure that the protective tap tabs are folded out on the front of the skid plate

Position the skid plate at the lower grille push towards the bumper cover until the two clips engage.

15

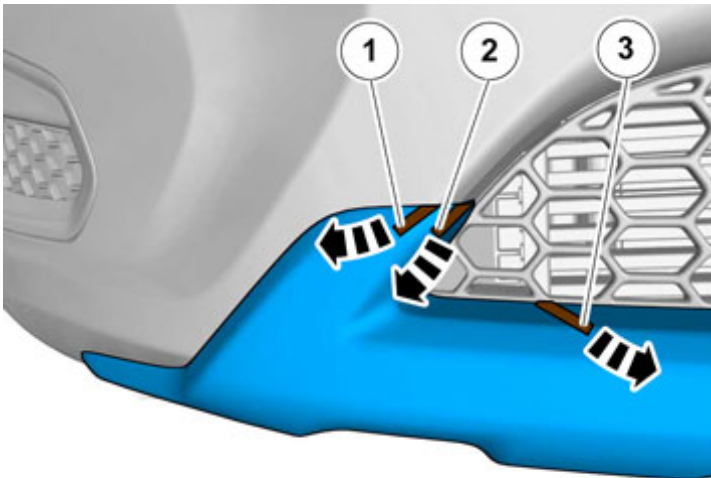

IMG-339273

Carefully pull off the protective tape around both sides in the sequence shown, and secure each time.

# Installation instructions, accessories

Volvo Car Corporation Gothenburg, Sweden

16

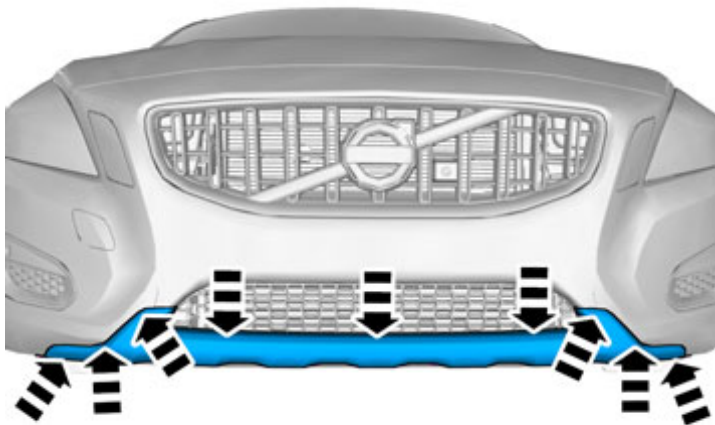

IMG-339284

Now press the skid plate into place opposite the tape all the way around.

17

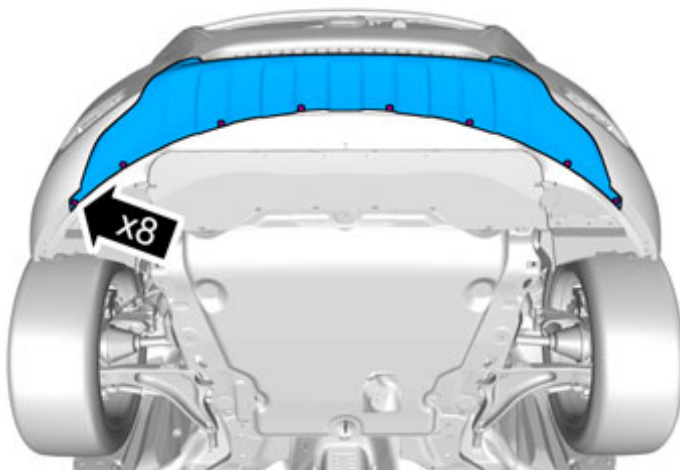

IMG-339285

Tighten the skid plate below using screws from the kit. Start in the centre and work towards the sides.