

Installation instructions, accessories

Volvo Car Corporation Gothenburg, Sweden

Instruction No 31316556 **Version** 1.1 **Part. No.** 31334457, 31295410

Cruise control

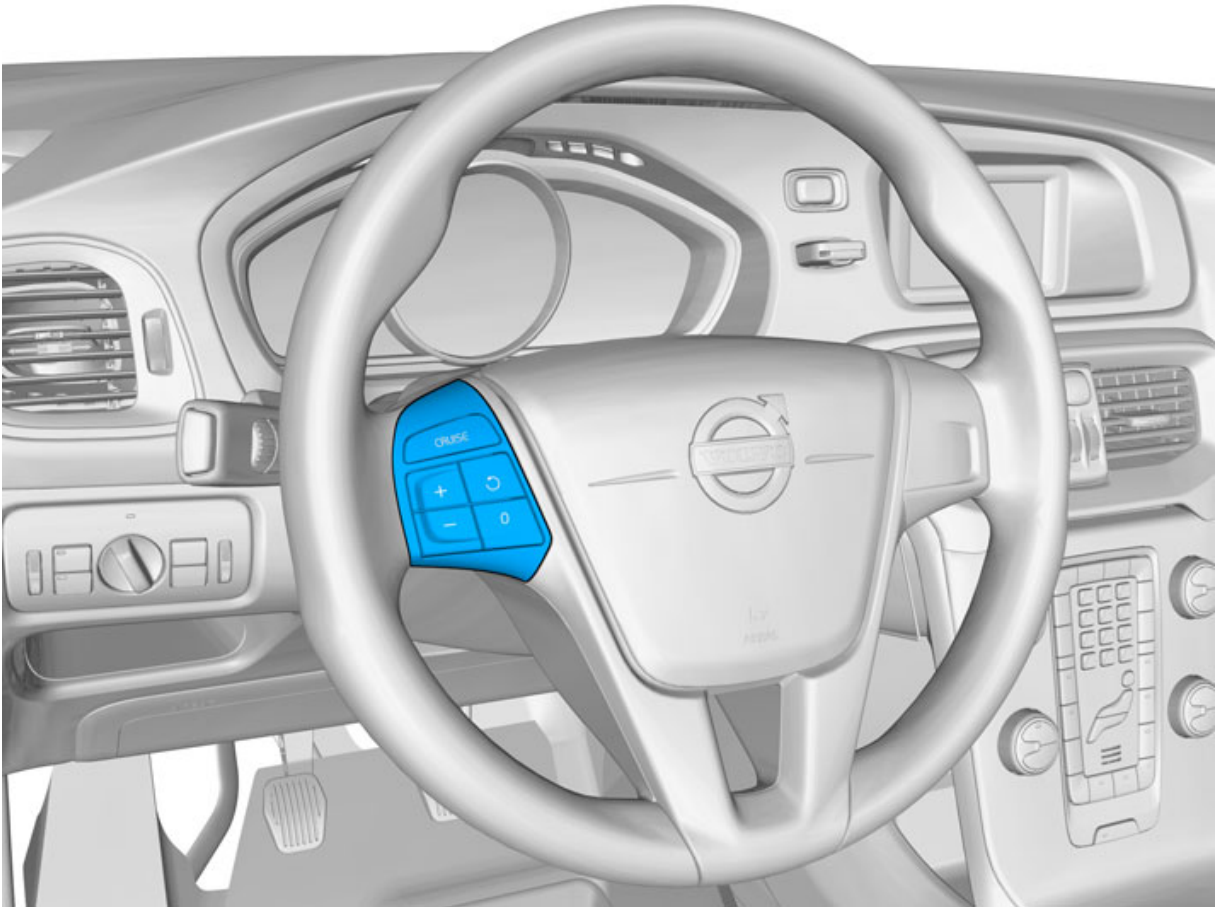

IMG-349343

Equipment

VIDA

IMG-242205

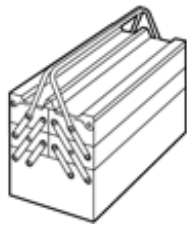

IMG-345497

Installation instructions, accessories

Volvo Car Corporation Gothenburg, Sweden

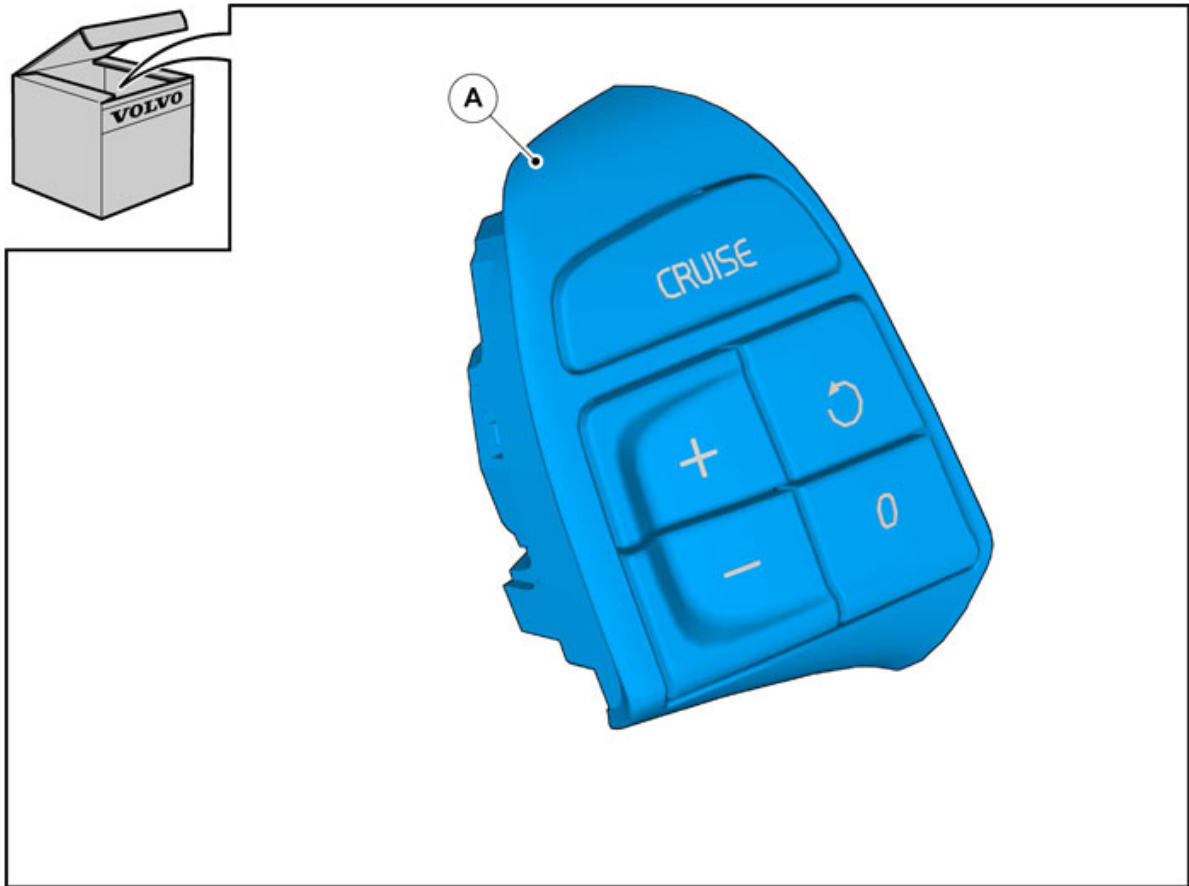

IMG-349344

Installation instructions, accessories

Volvo Car Corporation Gothenburg, Sweden

Information

1

Read through all of the instructions before starting installation.

Notifications and warning texts are for your safety and to minimise the risk of something breaking during installation.

Ensure that all tools stated in the instructions are available before starting installation.

Certain steps in the instructions are only presented in the form of images. Explanatory text is also given for more complicated steps.

In the event of any problems with the instructions or the accessory, contact your local Volvo dealer.

Color symbols

2



IMG-363036

Note!

This colour chart displays (in colour print and electronic version) the importance of the different colours used in the images of the method steps.

1. Used for focused component, the component with which you will do something.
 2. Used as extra colors when you need to show or differentiate additional parts.
 3. Used for attachments that are to be removed/installed. May be screws, clips, connectors, etc.
 4. Used when the component is not fully removed from the vehicle but only hung to the side.
 5. Used for standard tools and special tools.
 6. Used as background color for vehicle components.
-

Removal

Installation instructions, accessories

Volvo Car Corporation Gothenburg, Sweden

3

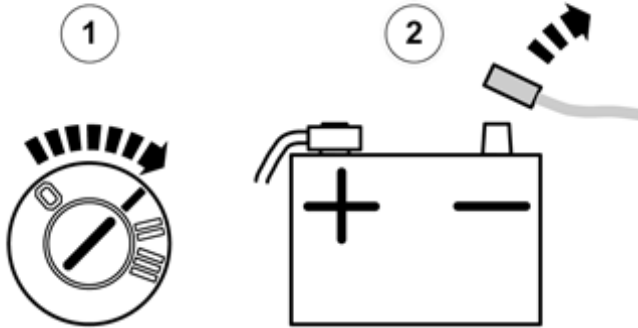

Warning!

The supplemental restraint system (SRS) is active for a certain length of time after the power supply has been disconnected. Wait for a minimum of 30 seconds before disconnecting or removing any SRS components.

1. Turn on the ignition.
2. Remove the battery's negative cable.

IMG-332180

4

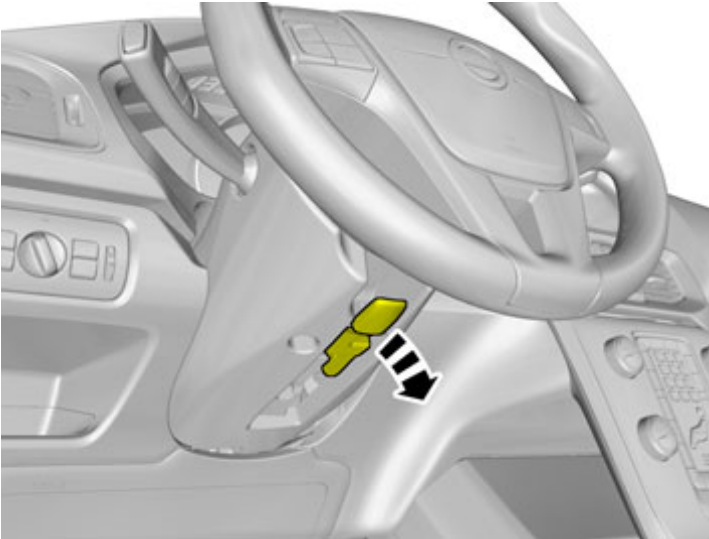

IMG-349356

Installation instructions, accessories

Volvo Car Corporation Gothenburg, Sweden

5

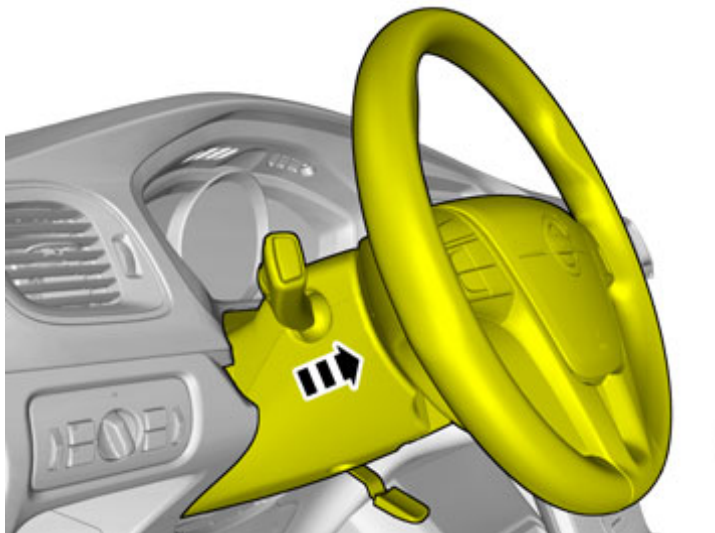

IMG-349353

6

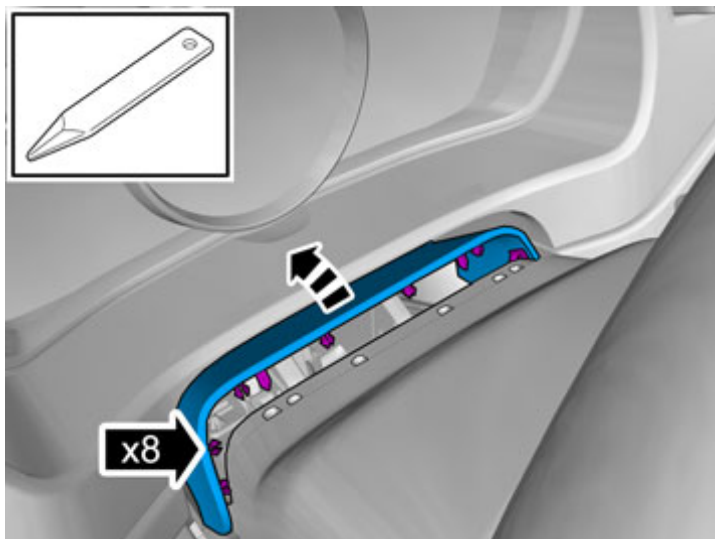

IMG-349354

Detach the panel.

Installation instructions, accessories

Volvo Car Corporation Gothenburg, Sweden

7

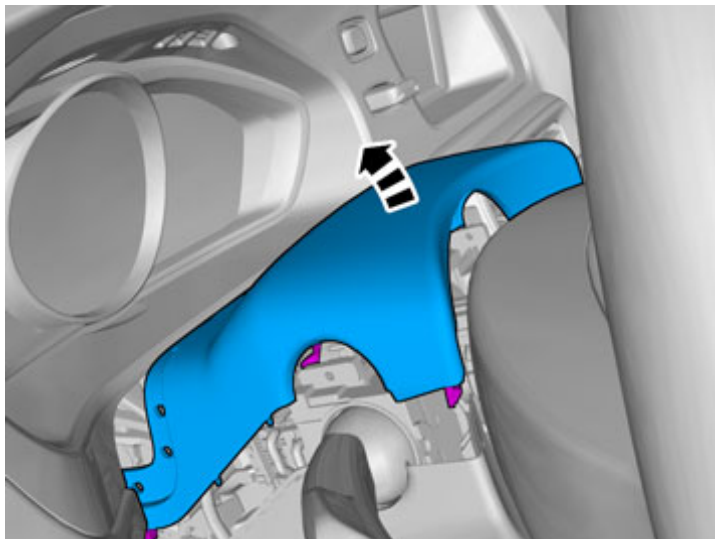

IMG-349355

Remove the panel.

8

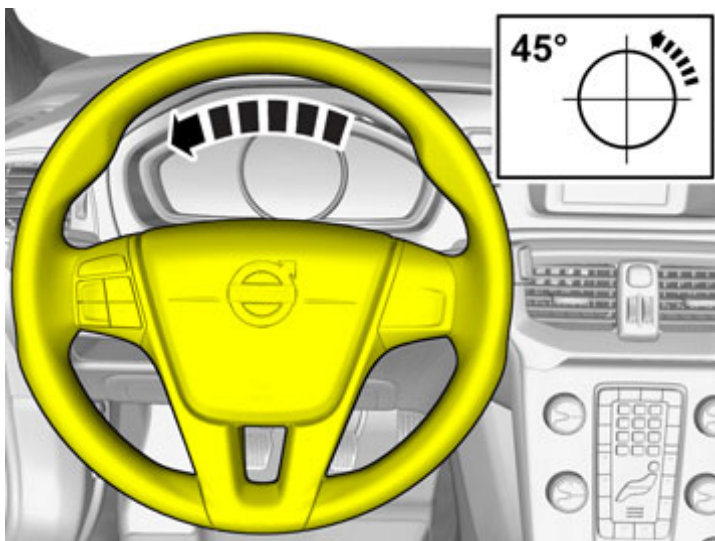

IMG-349357

Installation instructions, accessories

Volvo Car Corporation Gothenburg, Sweden

9
mm

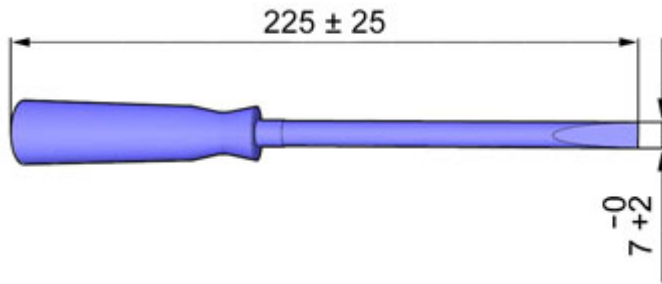

IMG-337683

10

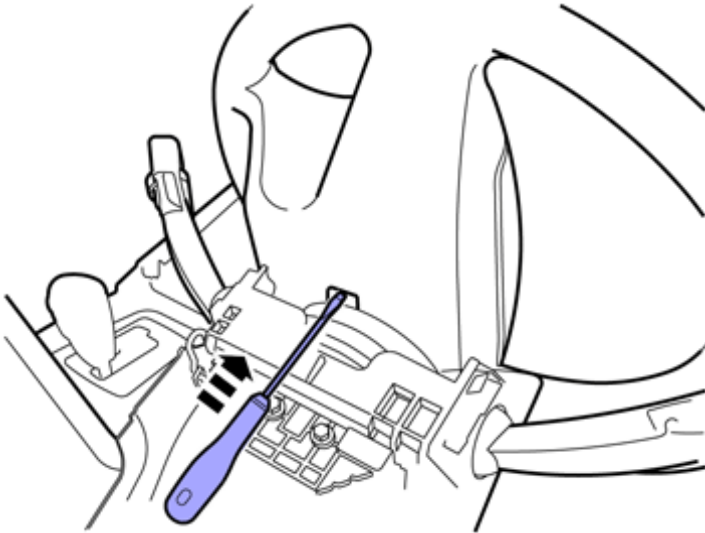

IMG-344725

Installation instructions, accessories

Volvo Car Corporation Gothenburg, Sweden

11

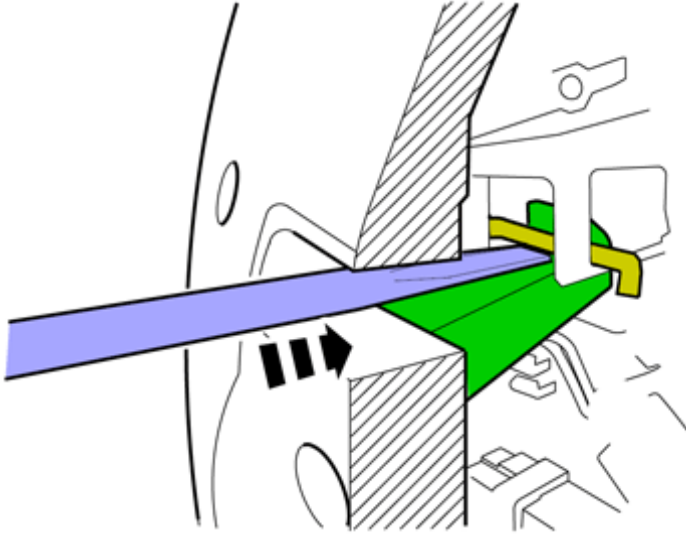

IMG-344726

12

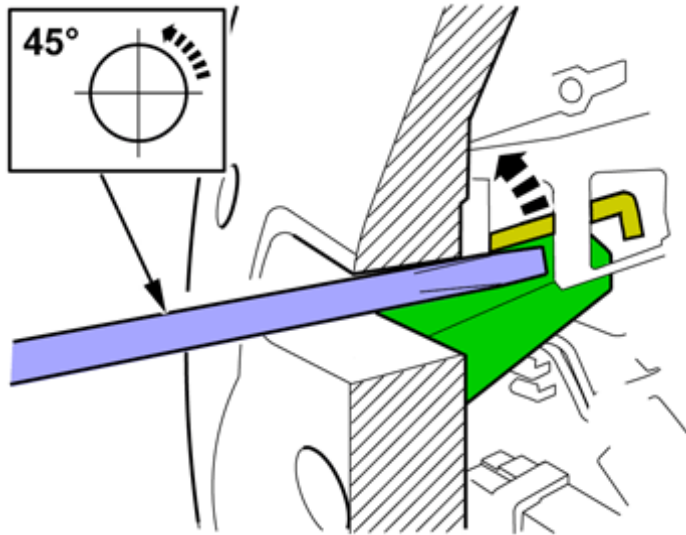

IMG-344727

Installation instructions, accessories

Volvo Car Corporation Gothenburg, Sweden

13

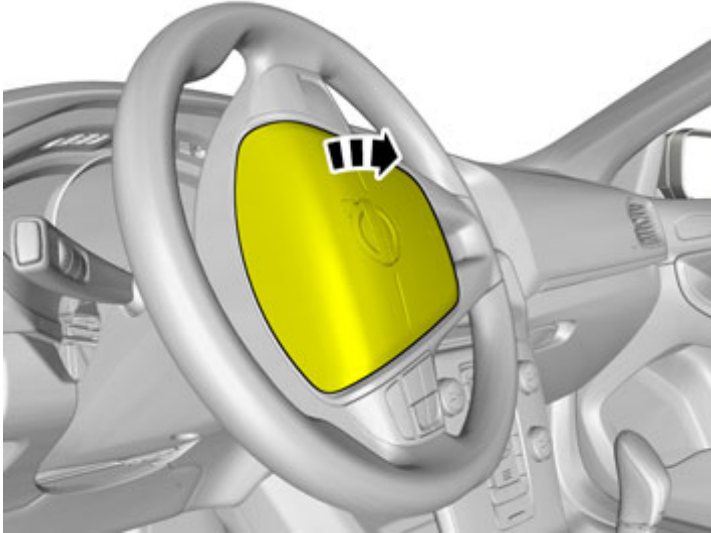

IMG-349360

14

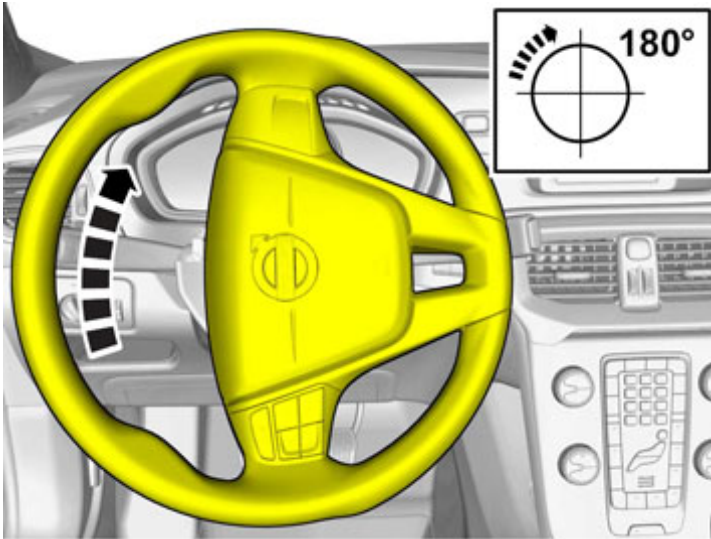

IMG-349359

Repeat on the other side.

Installation instructions, accessories

Volvo Car Corporation Gothenburg, Sweden

15



IMG-349364

Turn the steering wheel into neutral position.

16

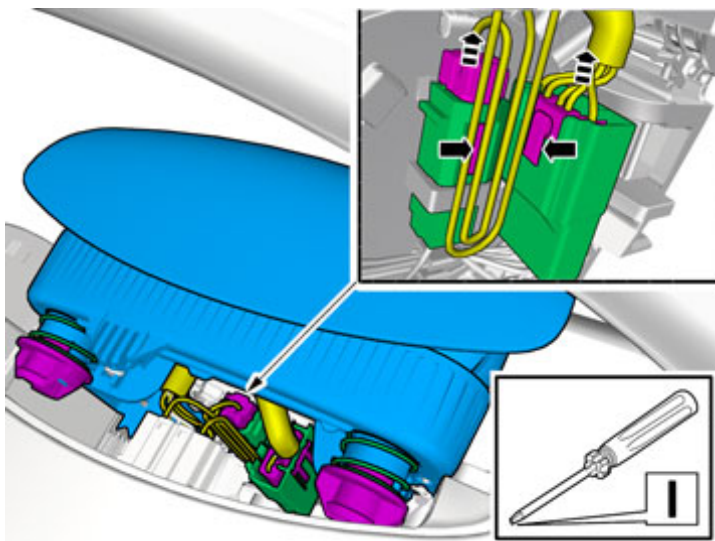

IMG-344730

Release the connector's catch.

Disconnect the connectors.

Installation instructions, accessories

Volvo Car Corporation Gothenburg, Sweden

17

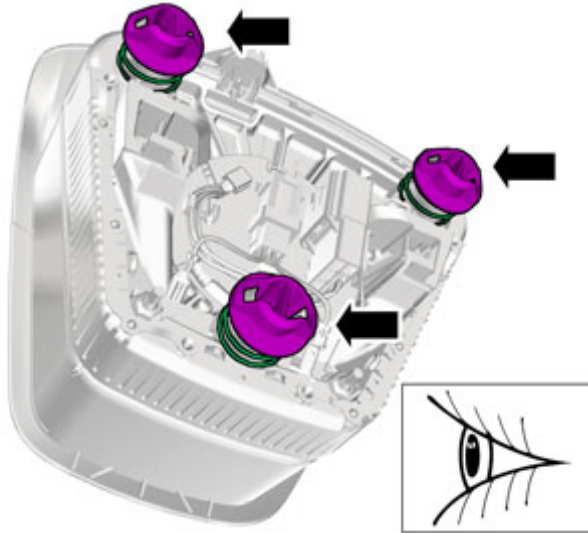

IMG-344731

18

Warning!
Place the airbag module with the front side facing up in a safe storage area during work.

19

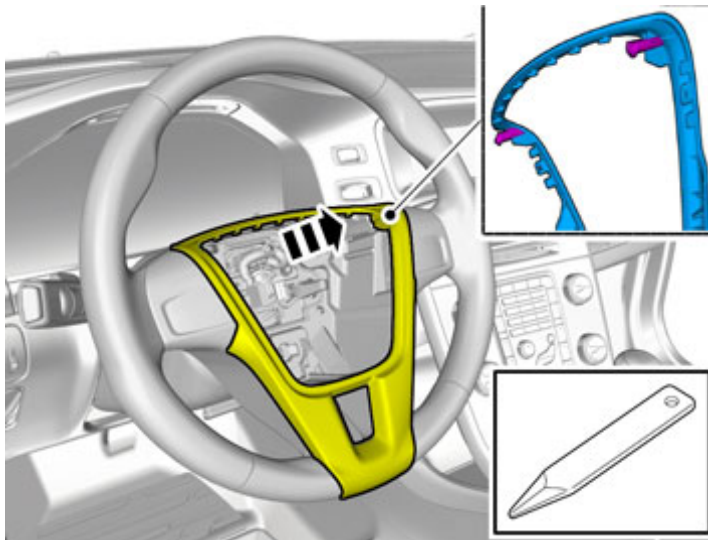

IMG-345559

Note!
This step requires considerable force.

Detach the panel.

Installation instructions, accessories

Volvo Car Corporation Gothenburg, Sweden

20

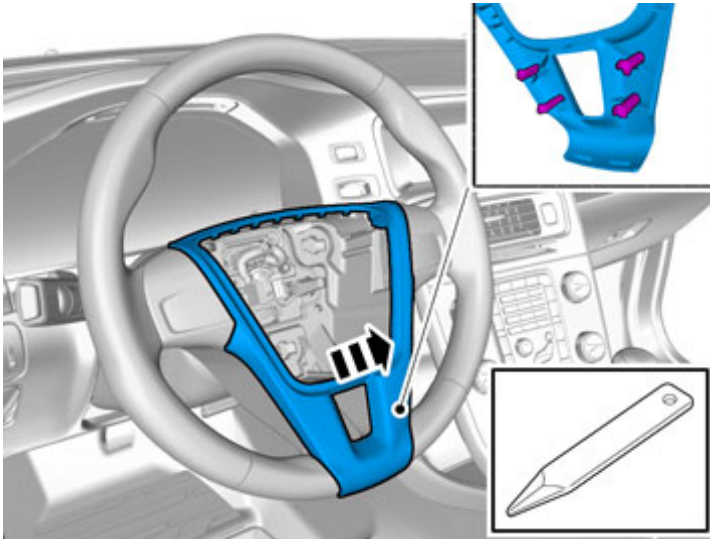

IMG-345560

Note!

This step requires considerable force.

Remove the panel.

21

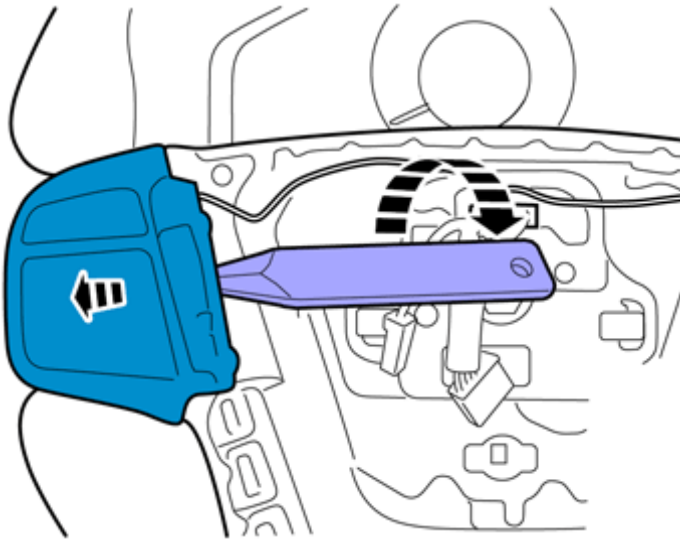

IMG-349368

Note!

This step requires considerable force.

Installation instructions, accessories

Volvo Car Corporation Gothenburg, Sweden

22

Connect the connector.

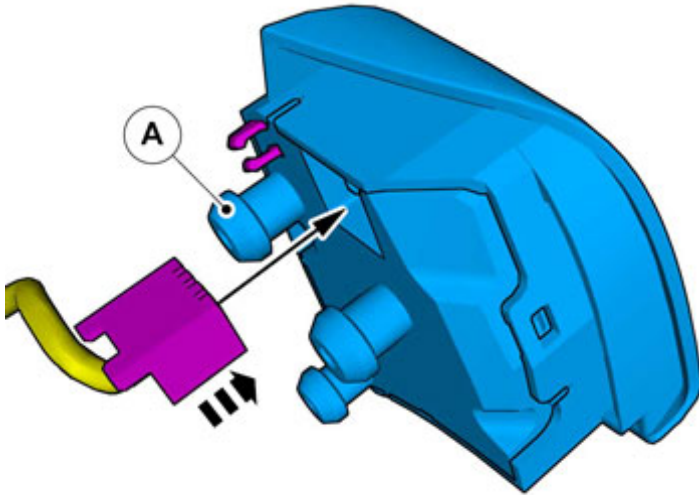

IMG-349370

23

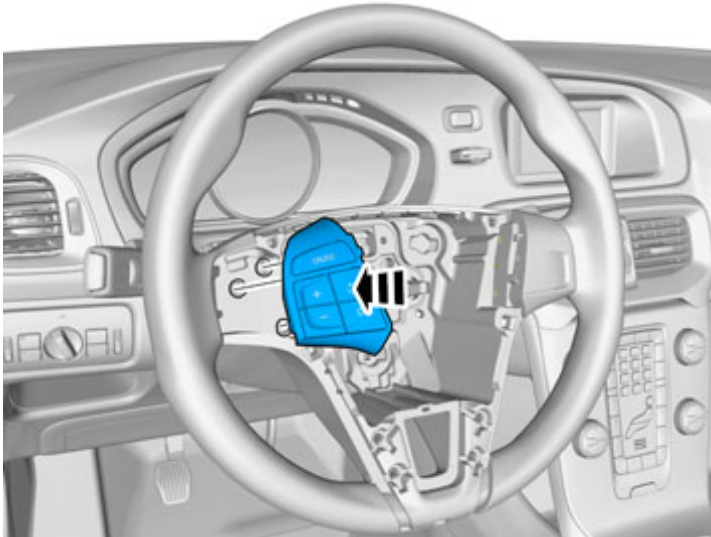

IMG-349371

Installation instructions, accessories

Volvo Car Corporation Gothenburg, Sweden

24

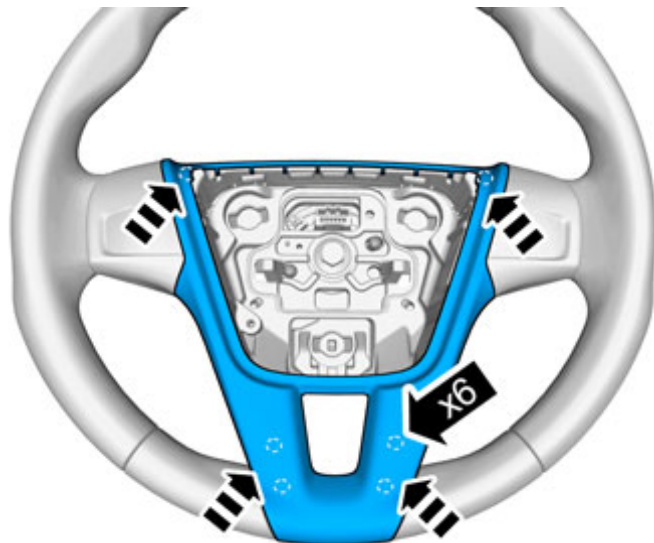

IMG-339675

Install the panel.

25

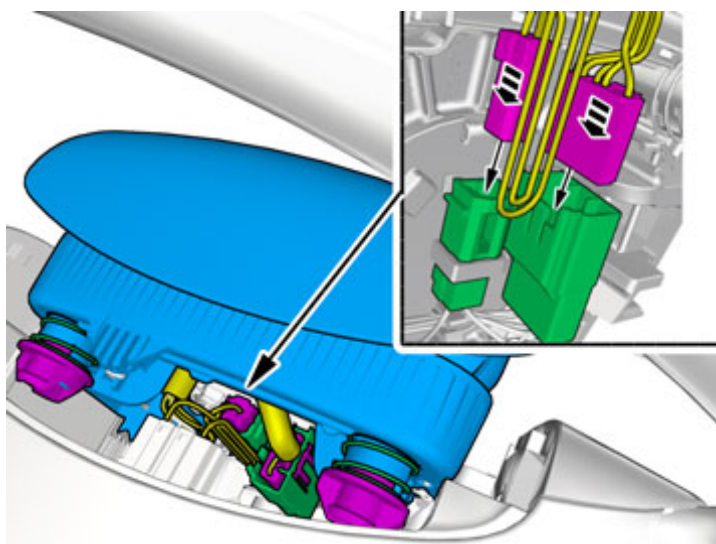

IMG-344748

Connect the connectors.

Installation instructions, accessories

Volvo Car Corporation Gothenburg, Sweden

26



IMG-349387

Caution!

Make sure that no part of the wiring harness is trapped.

Reinstall the removed parts in reverse order.

27

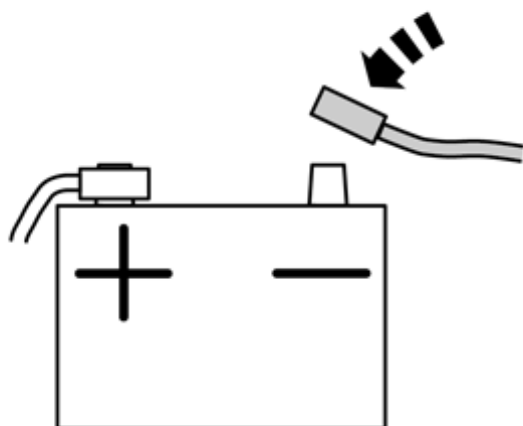

IMG-336901

Reinstall the battery's negative cable.

Installation instructions, accessories

Volvo Car Corporation Gothenburg, Sweden

28

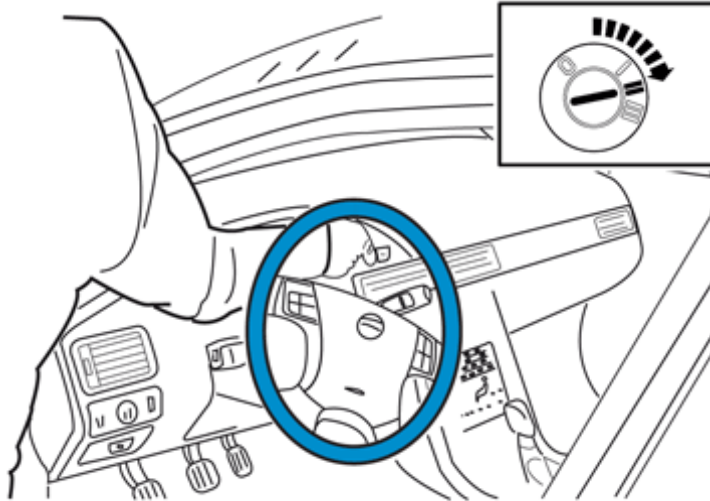

Warning!

When switching the ignition on for the first time after a battery disconnect and connect, make sure to stand outside the vehicle and only reach into the vehicle keeping clear of the air bag deployment areas.

IMG-336904

29

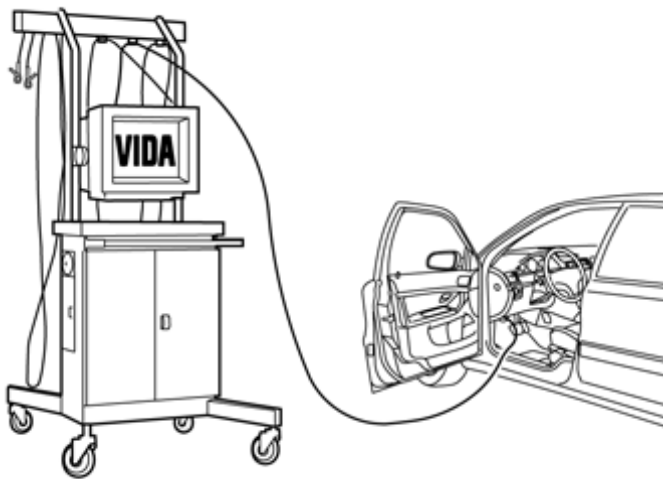

Download software (application) for the accessory's function according to the service information in VIDA. See VIDA or the accessories catalogue for software part number.

IMG-242268