

# Installation instructions, accessories

Volvo Car Corporation Gothenburg, Sweden

Instruction No	Version	Part. No.
31330391	1.0	39818296, 39818277, 39818279, 39818280, 39818281, 39818285, 39818286, 39818287, 39818288, 39818292, 39818293, 39818294, 39818295, 31330390, 39822049

## Bumper cover



IMG-354411

### Materials

Designation	Part number
Isopropanol	1161721

### Equipment

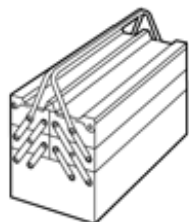

IMG-345497

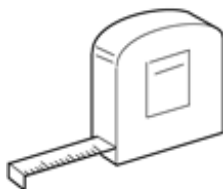

IMG-244945



IMG-239660

# Installation instructions, accessories

Volvo Car Corporation Gothenburg, Sweden

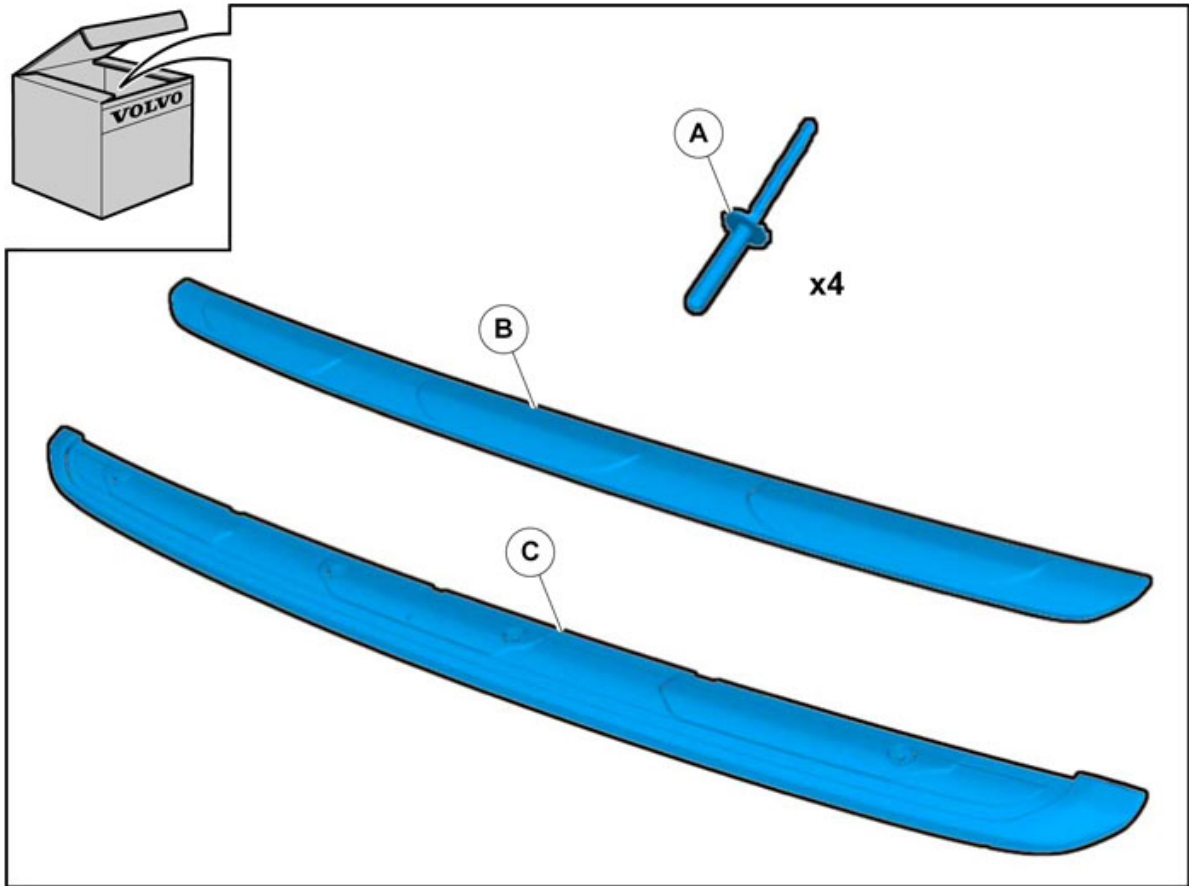

IMG-354412

# Installation instructions, accessories

Volvo Car Corporation Gothenburg, Sweden

---

## Information

---

1

Read through all of the instructions before starting installation.

Notifications and warning texts are for your safety and to minimise the risk of something breaking during installation.

Ensure that all tools stated in the instructions are available before starting installation.

Certain steps in the instructions are only presented in the form of images. Explanatory text is also given for more complicated steps.

In the event of any problems with the instructions or the accessory, contact your local Volvo dealer.

---

## Conditions

---

2

When installing, the car must retain a temperature of 20 degrees C.

After installation, the car must not be washed for 48 hours

After installation, the car must not be driven for 2 hours

---

## Color symbols

---

3

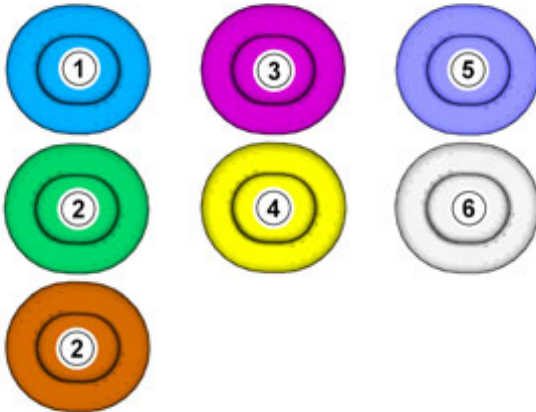

IMG-363036

### Note!

This colour chart displays (in colour print and electronic version) the importance of the different colours used in the images of the method steps.

1. Used for focused component, the component with which you will do something.
  2. Used as extra colors when you need to show or differentiate additional parts.
  3. Used for attachments that are to be removed/installed. May be screws, clips, connectors, etc.
  4. Used when the component is not fully removed from the vehicle but only hung to the side.
  5. Used for standard tools and special tools.
  6. Used as background color for vehicle components.
- 

## Accessory installation

---

# Installation instructions, accessories

Volvo Car Corporation Gothenburg, Sweden

4

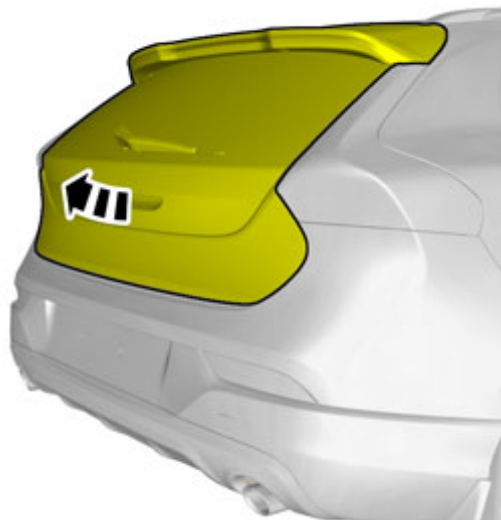

IMG-354413

5

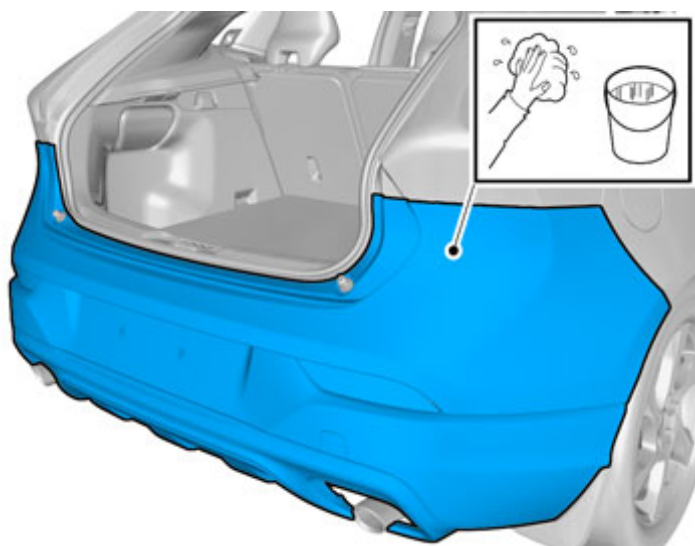

IMG-354414

Clean the surface.

Allow to dry.

# Installation instructions, accessories

Volvo Car Corporation Gothenburg, Sweden

6

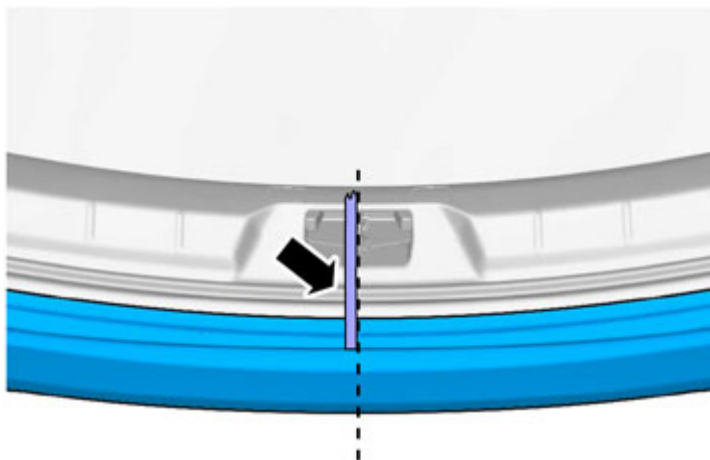

Use suitable tape to indicate the center.

IMG-354449

7

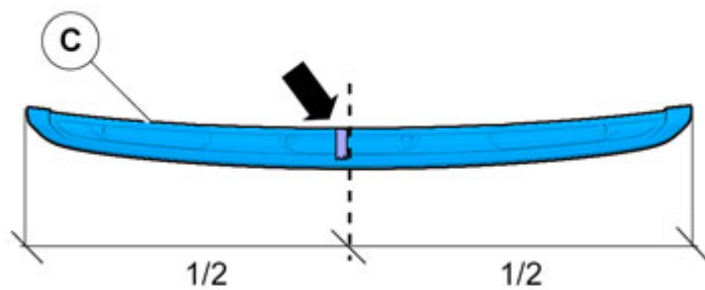

Use suitable tape to indicate the center.

IMG-354415

# Installation instructions, accessories

Volvo Car Corporation Gothenburg, Sweden

8

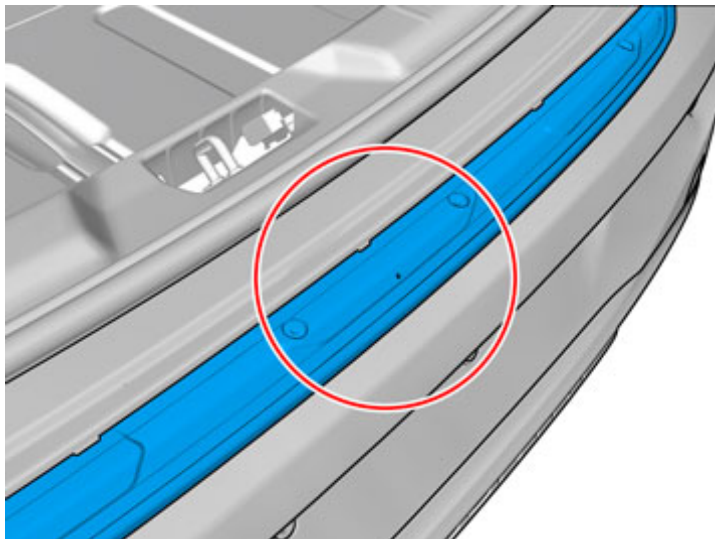

IMG-372653

**Note!**  
Orientation view

9

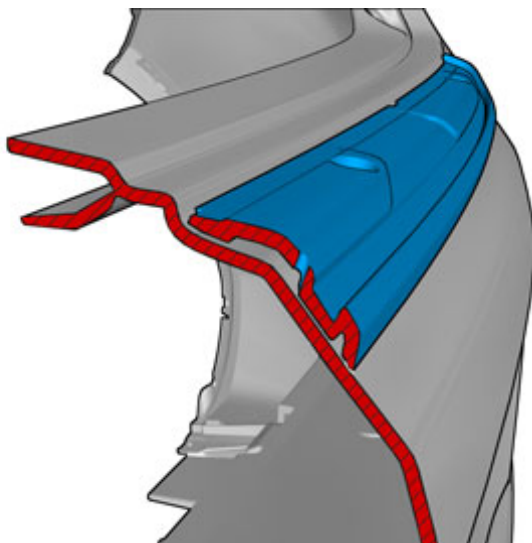

IMG-372654

**Note!**  
Note the position.

# Installation instructions, accessories

Volvo Car Corporation Gothenburg, Sweden

10

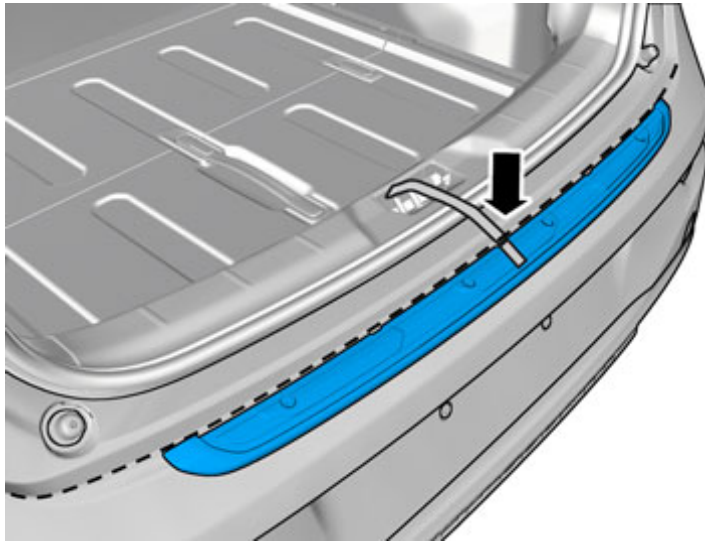

IMG-354416

Adjust the position of the Bumper Protection using the tape marks.

11

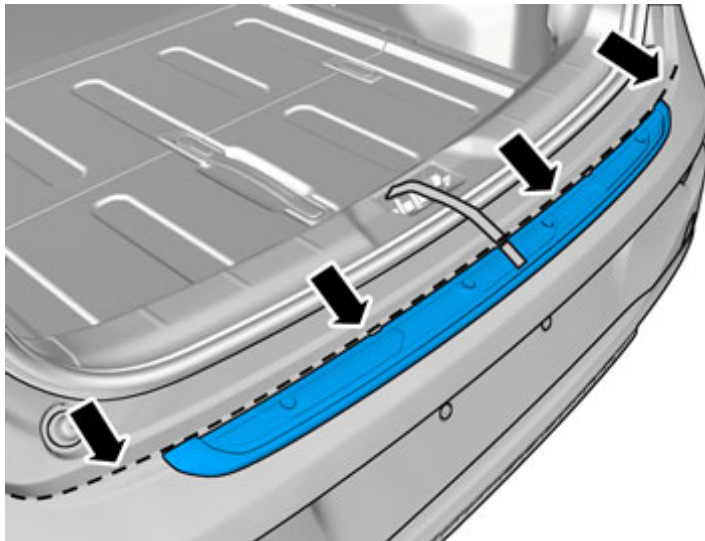

IMG-354417

**Note!**  
Make sure that the Bumper Protection is installed on the flat bumper surface only, not covering any sharp radius.

# Installation instructions, accessories

Volvo Car Corporation Gothenburg, Sweden

12

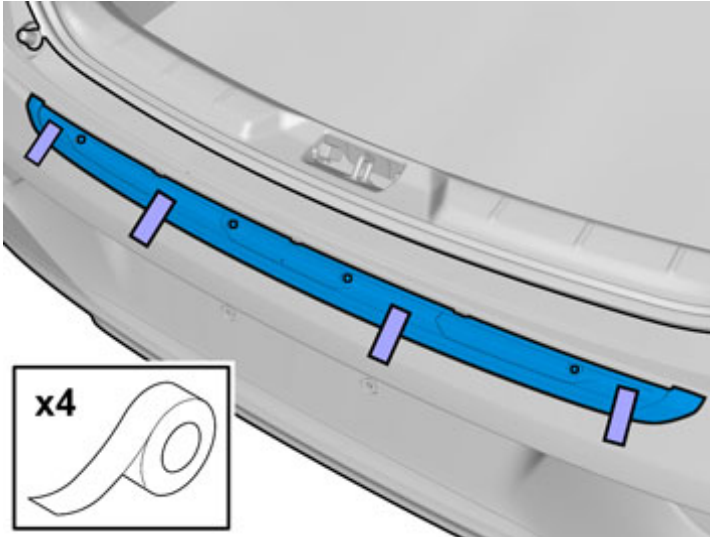

IMG-354420

**Note!**

Use tape to temporarily fix the bumper cover in the correct position.

13

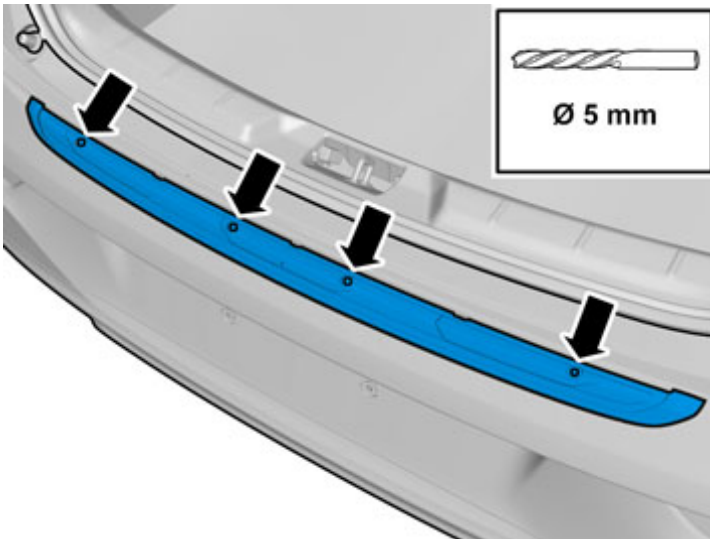

IMG-354423

Drill the holes.

Remove the swarf.



# Installation instructions, accessories

Volvo Car Corporation Gothenburg, Sweden

14

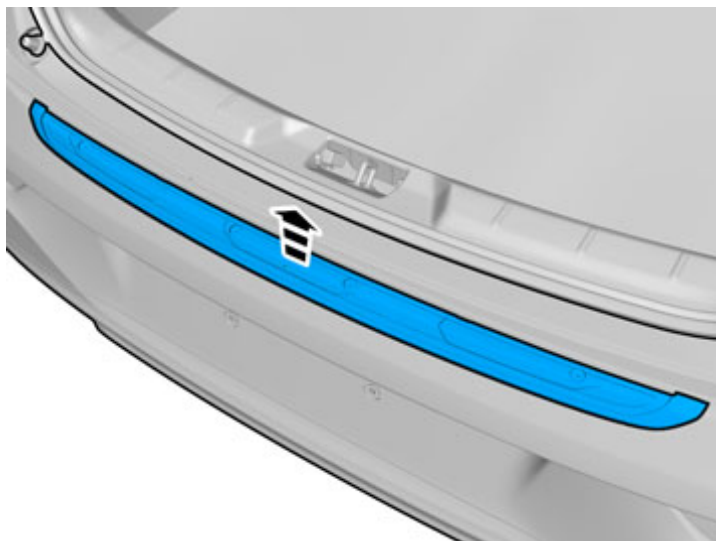

IMG-354422

15

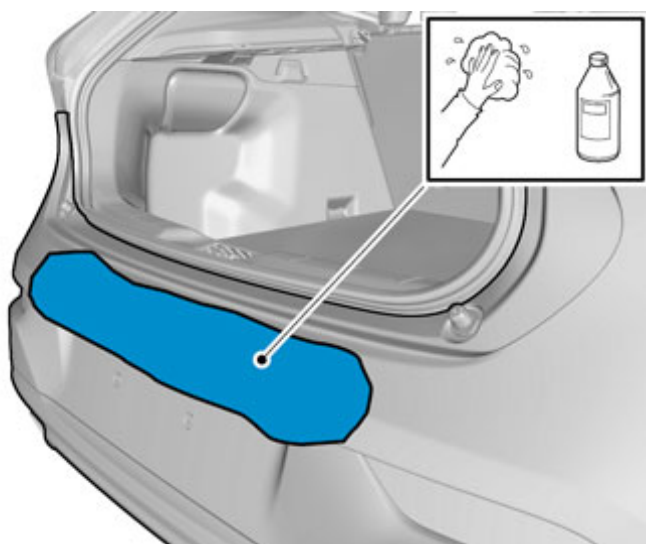

IMG-354424

Clean the Bumper Cover surface.

Allow to dry.

**Use:** 1161721, Isopropanol

# Installation instructions, accessories

Volvo Car Corporation Gothenburg, Sweden

16

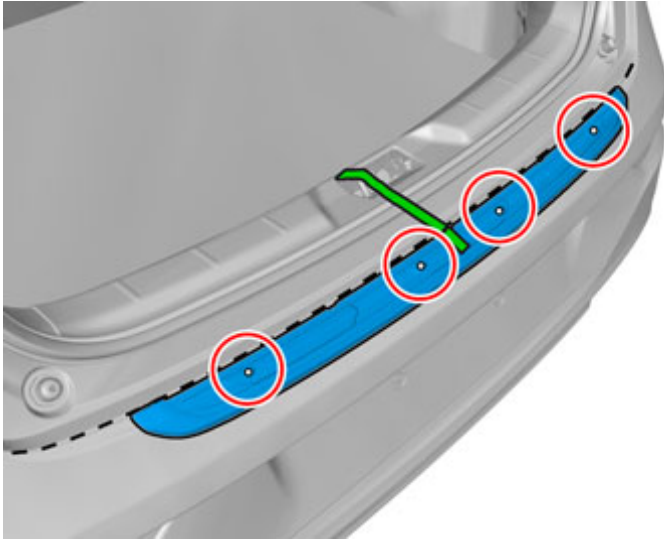

IMG-354607

Adjust the position of the Bumper Protection using the tape marks.

Center the holes against each other.

17

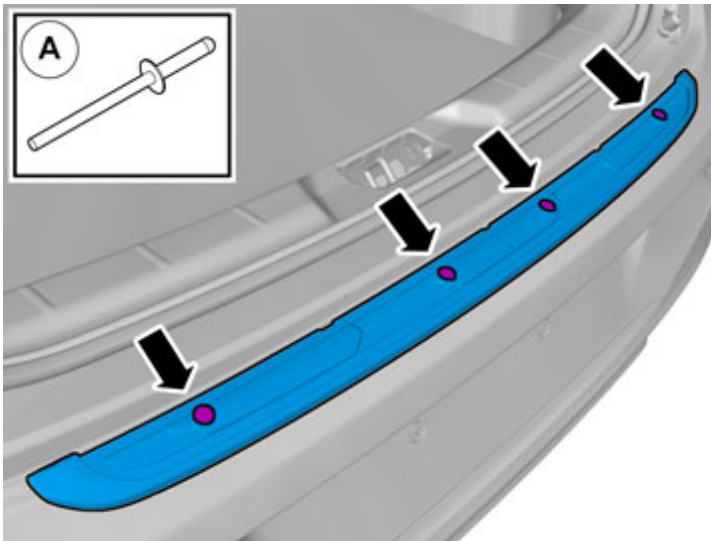

IMG-354436

# Installation instructions, accessories

Volvo Car Corporation Gothenburg, Sweden

18

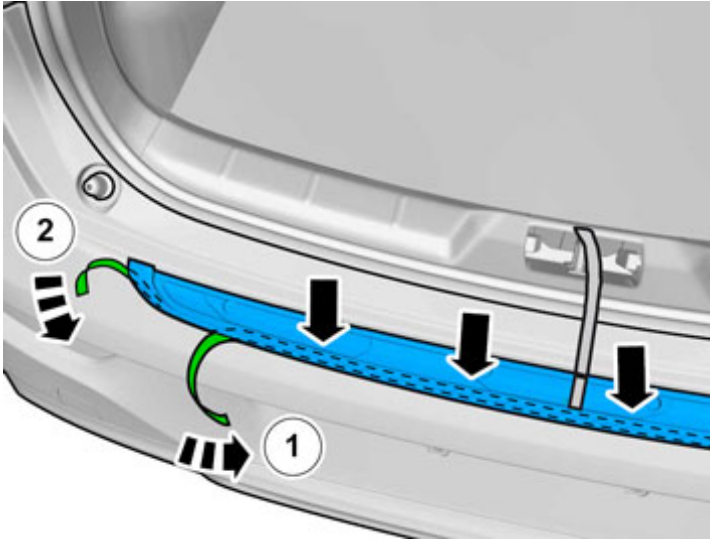

IMG-354431

Remove the protective film.

Thoroughly press, by hand, all over the Bumper Protection to make it cling properly.

19

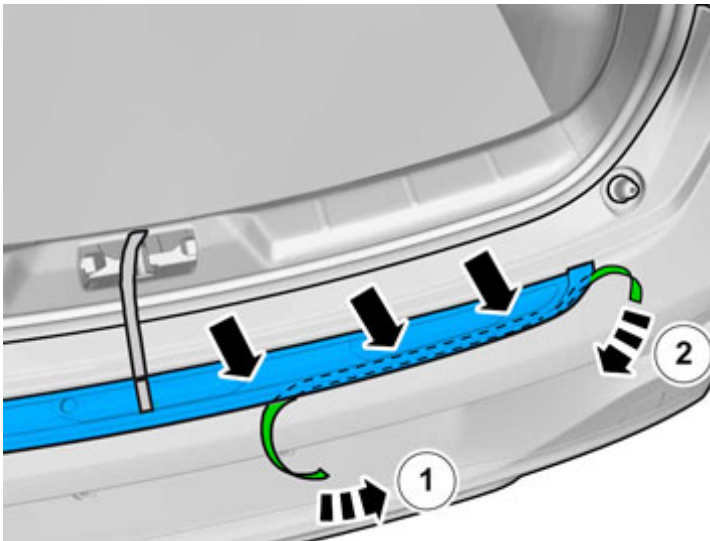

IMG-354434

Remove the protective film.

Thoroughly press, by hand, all over the Bumper Protection to make it cling properly.

# Installation instructions, accessories

Volvo Car Corporation Gothenburg, Sweden

20

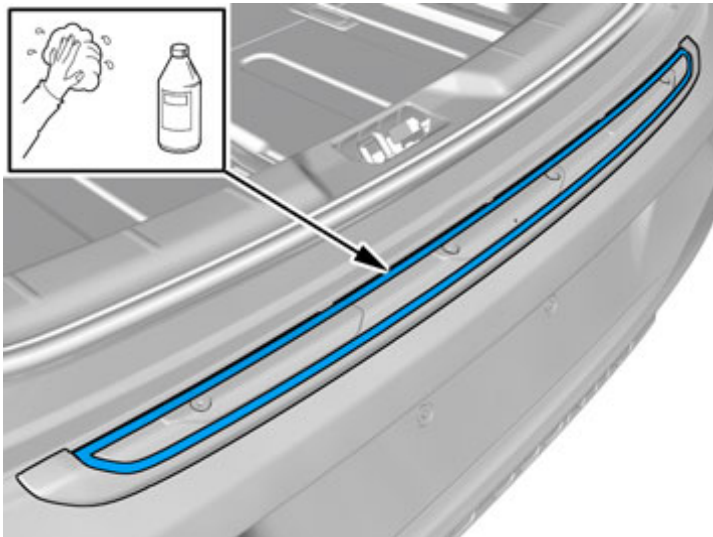

IMG-372661

Clean the surface.

Allow to dry.

**Use:** 1161721, Isopropanol

21

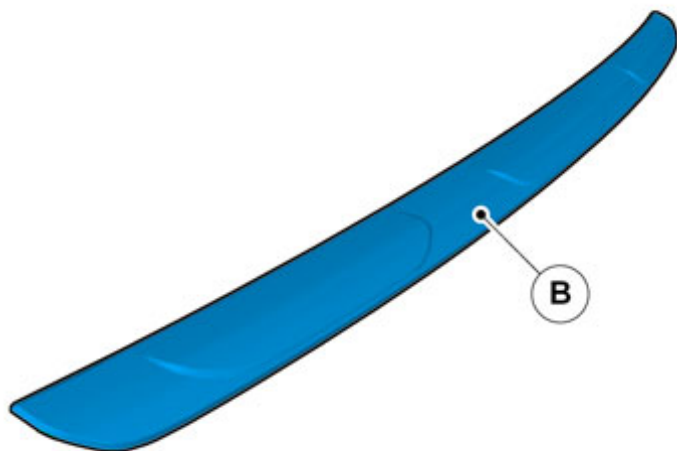

IMG-354437

# Installation instructions, accessories

Volvo Car Corporation Gothenburg, Sweden

22

Remove the protective film.

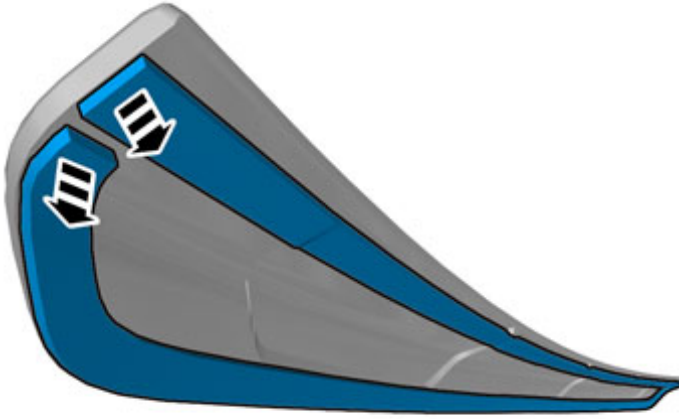

IMG-354438

23

**Note!**  
Orientation view

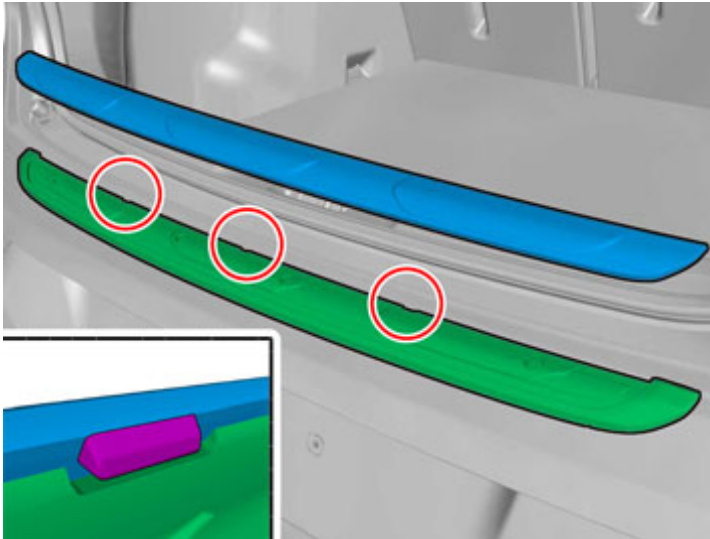

IMG-354439

# Installation instructions, accessories

Volvo Car Corporation Gothenburg, Sweden

24

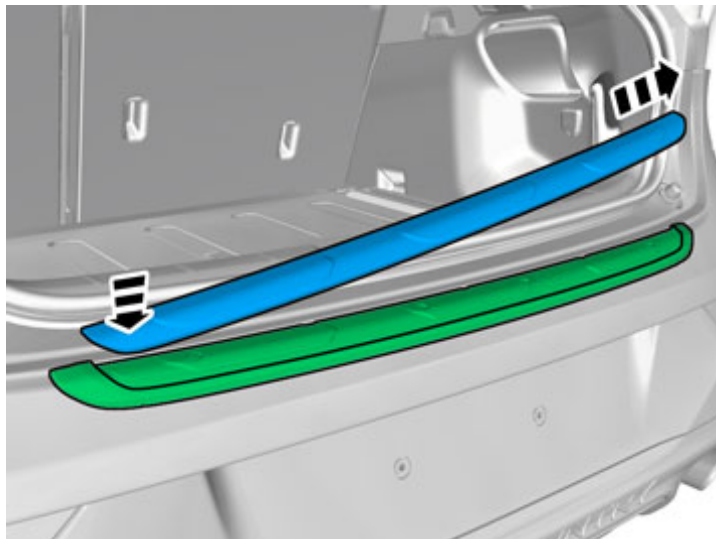

IMG-371798

**Note!**

Keep the part stretched during installation.

25

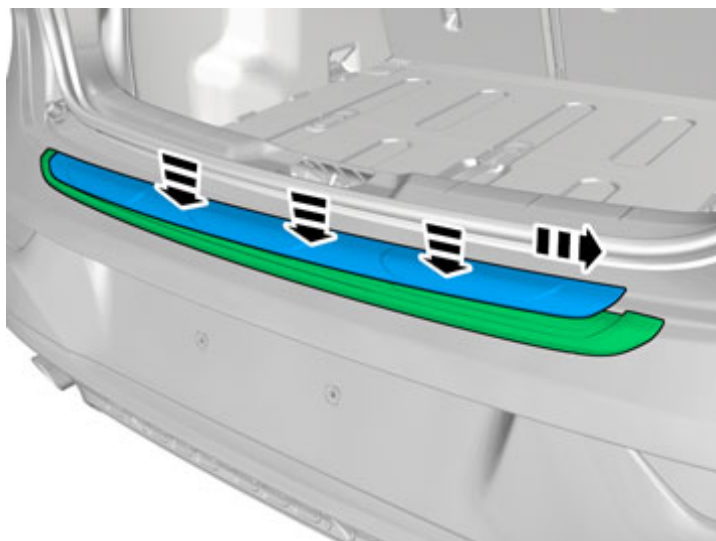

IMG-371810

**Note!**

Keep the part stretched during installation.

# Installation instructions, accessories

Volvo Car Corporation Gothenburg, Sweden

26

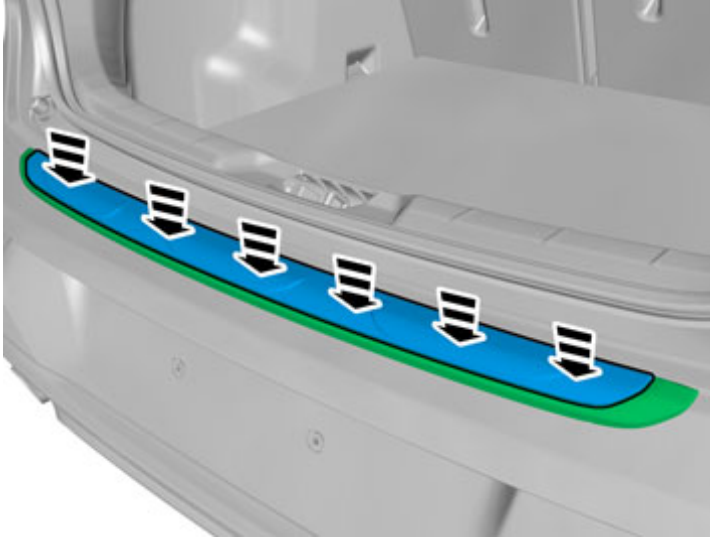

IMG-354440

Thoroughly press, by hand, all over the Bumper Protection to make it cling properly.