

# Installation instructions, accessories

Volvo Car Corporation Gothenburg, Sweden

**Instruction No** 31373395    **Version** 1.0    **Part. No.** 31373394, 31373393, 31373392, 31373391

## Sport pedals

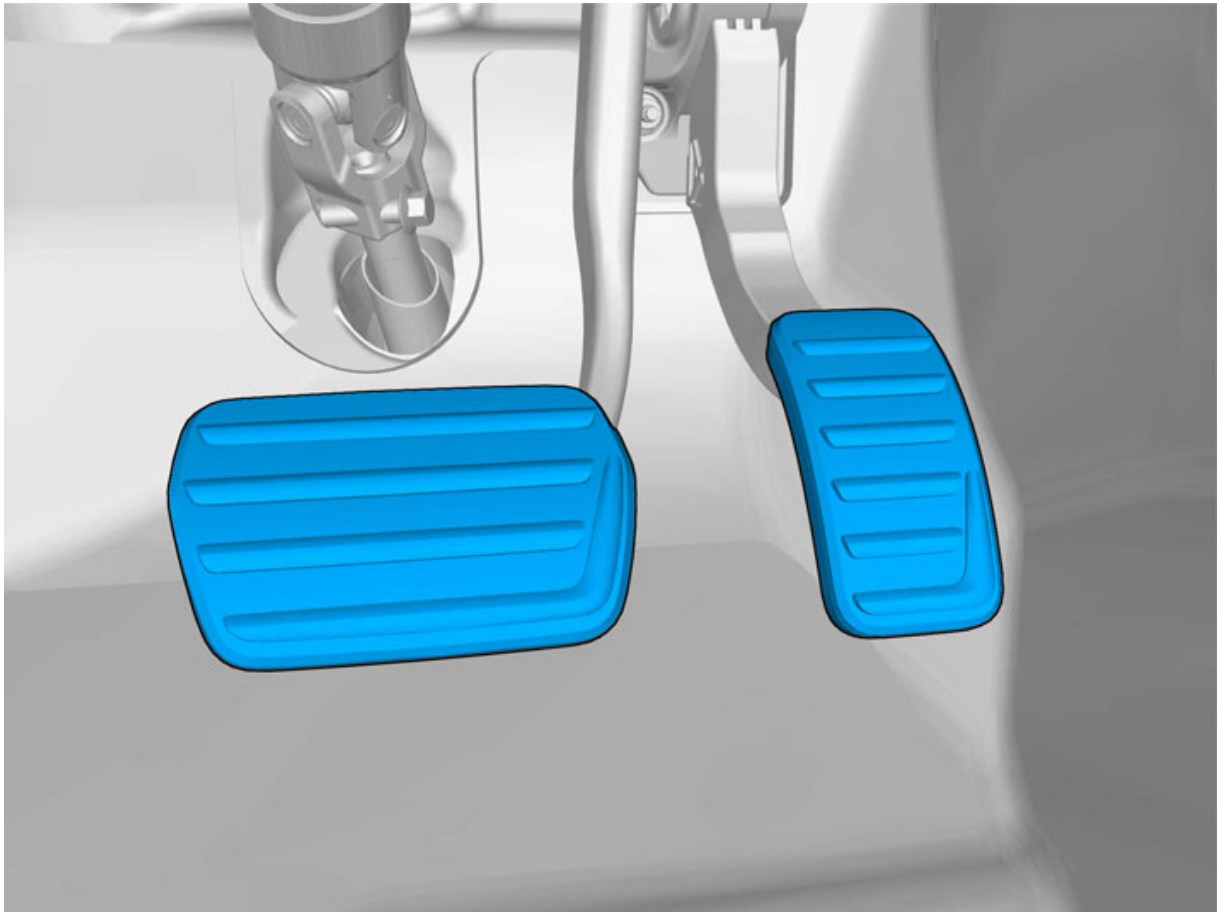

IMG-357331

### Equipment



IMG-239667



IMG-309504

# Installation instructions, accessories

Volvo Car Corporation Gothenburg, Sweden

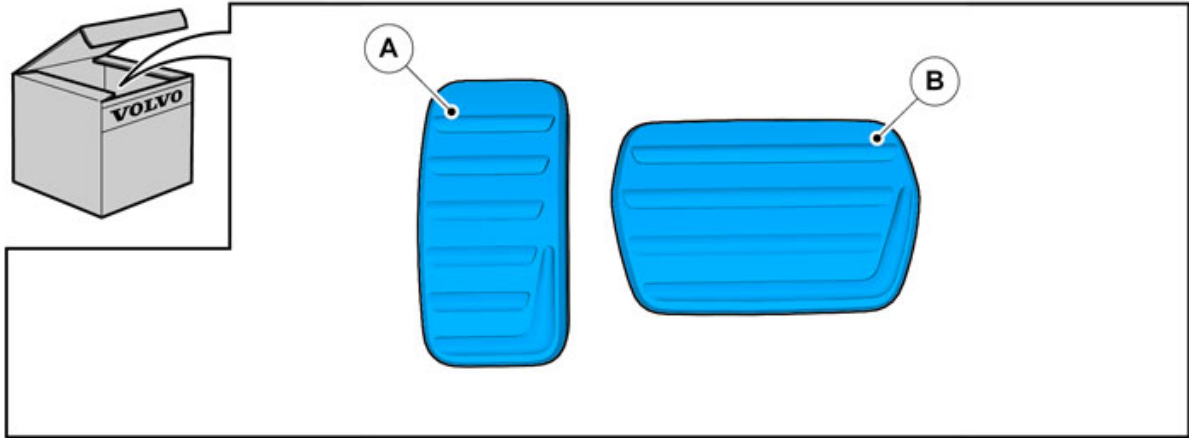
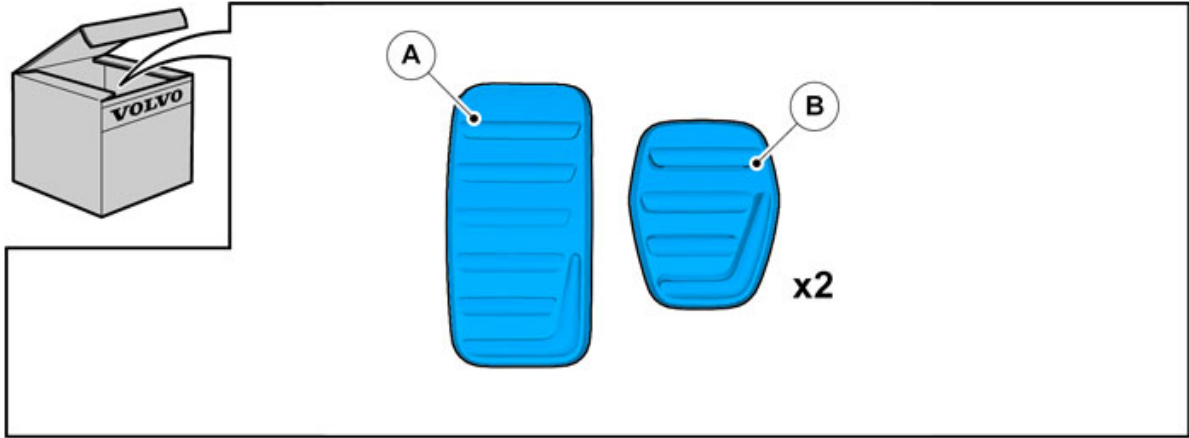

IMG-357336

# Installation instructions, accessories

Volvo Car Corporation Gothenburg, Sweden

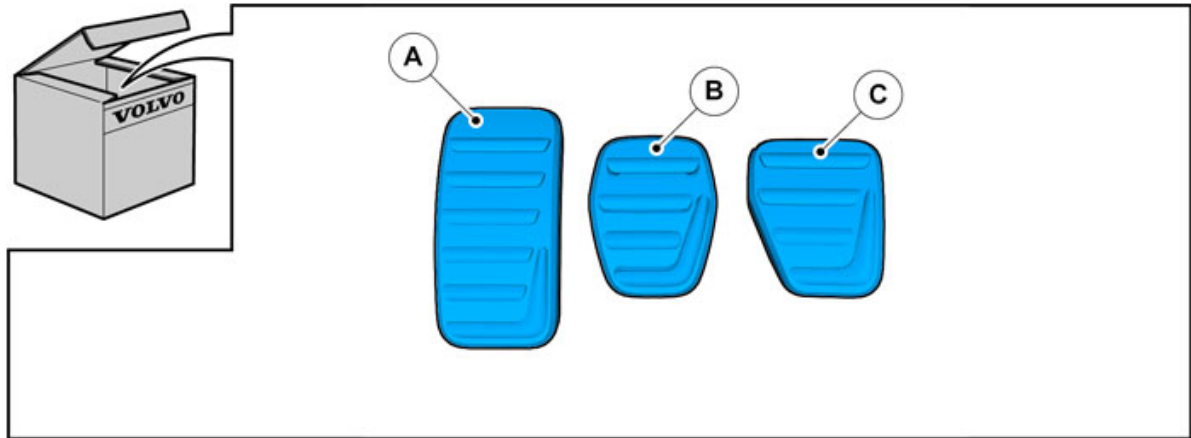

IMG-358150

# Installation instructions, accessories

Volvo Car Corporation Gothenburg, Sweden

---

## Information

---

1

Read through all of the instructions before starting installation.

Notifications and warning texts are for your safety and to minimise the risk of something breaking during installation.

Ensure that all tools stated in the instructions are available before starting installation.

Certain steps in the instructions are only presented in the form of images. Explanatory text is also given for more complicated steps.

In the event of any problems with the instructions or the accessory, contact your local Volvo dealer.

---

## Color symbols

---

2

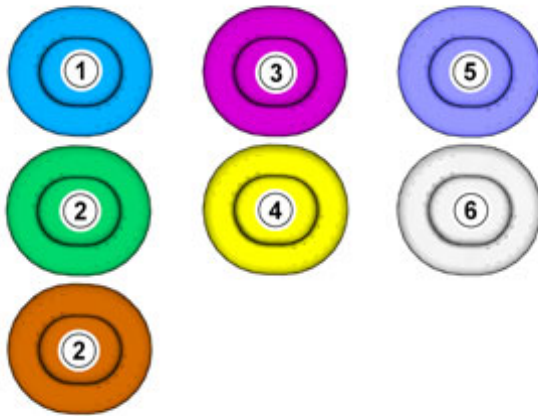

IMG-363036

### Note!

This colour chart displays (in colour print and electronic version) the importance of the different colours used in the images of the method steps.

1. Used for focused component, the component with which you will do something.
  2. Used as extra colors when you need to show or differentiate additional parts.
  3. Used for attachments that are to be removed/installed. May be screws, clips, connectors, etc.
  4. Used when the component is not fully removed from the vehicle but only hung to the side.
  5. Used for standard tools and special tools.
  6. Used as background color for vehicle components.
- 

## Accessory installation

---

# Installation instructions, accessories

Volvo Car Corporation Gothenburg, Sweden

3

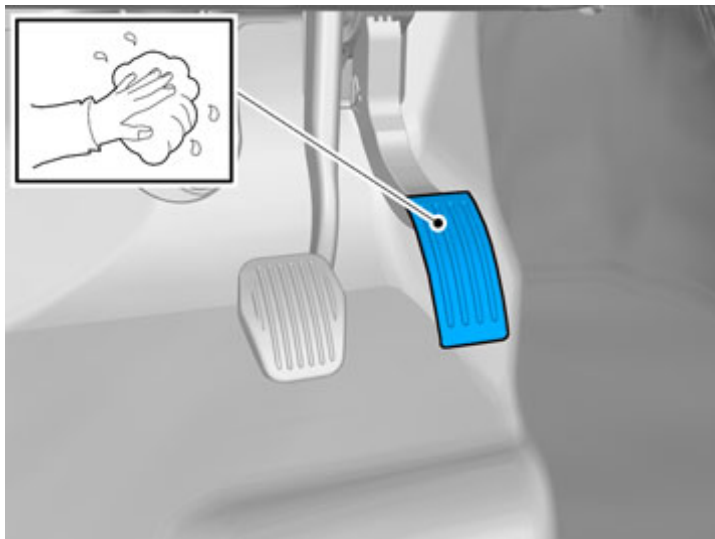

Clean the surface.

IMG-357337

4

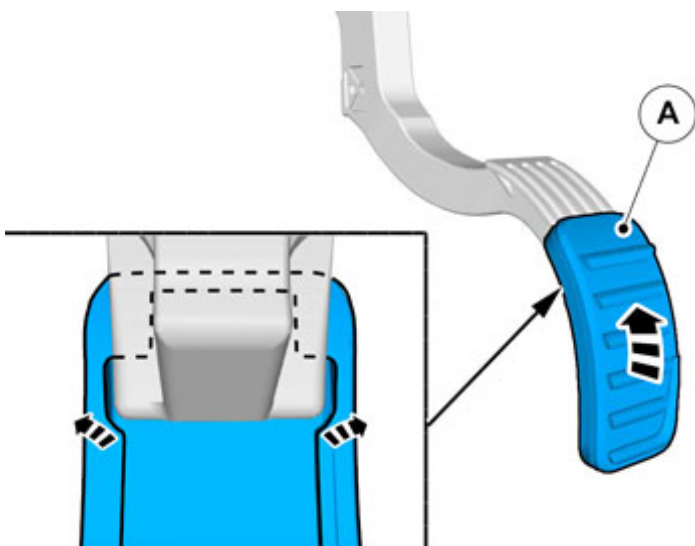

IMG-357346

# Installation instructions, accessories

Volvo Car Corporation Gothenburg, Sweden

5

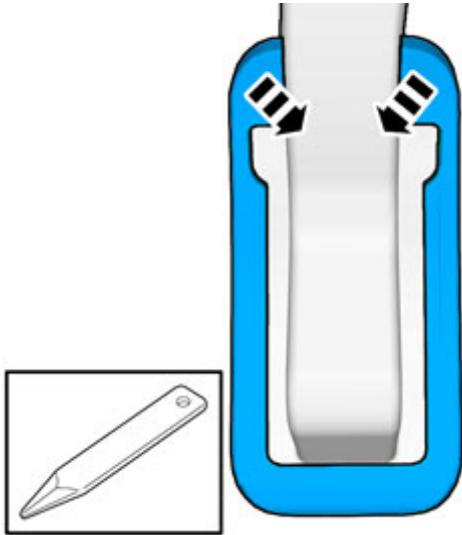

IMG-357376

6

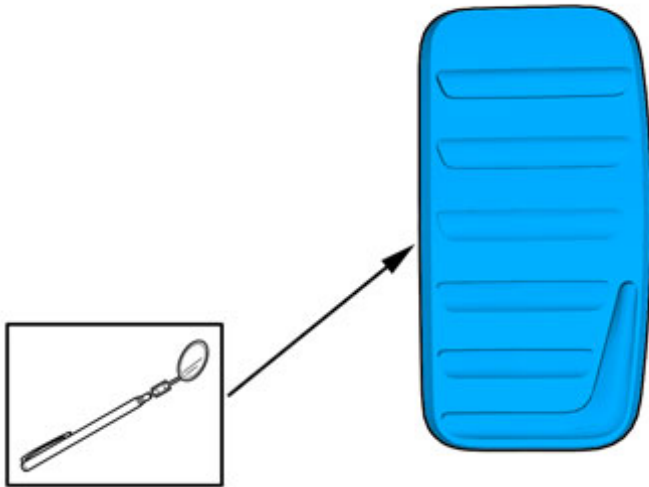

IMG-357377

**Caution!**  
Using a mirror check that the pedal rubber covers the edges of the pedal.

**Right-hand drive vehicles**

# Installation instructions, accessories

Volvo Car Corporation Gothenburg, Sweden

7

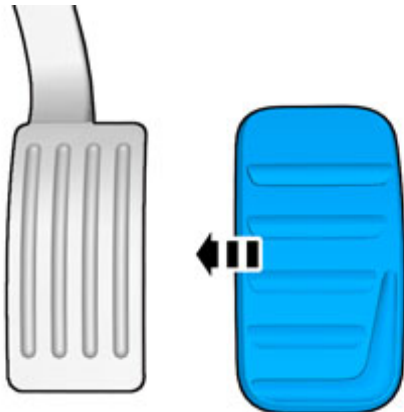

Hook the pedal rubber onto the long side of the accelerator pedal.

IMG-357378

8

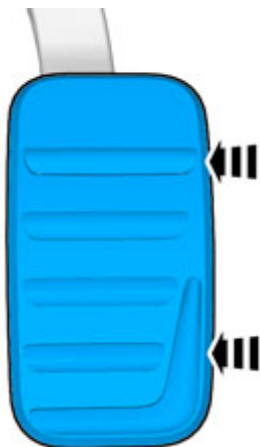

Press the pedal rubber towards the pedal and at the same time fold the pedal rubber's profile over the pedal using a straightening tool.

IMG-357379

# Installation instructions, accessories

Volvo Car Corporation Gothenburg, Sweden

9

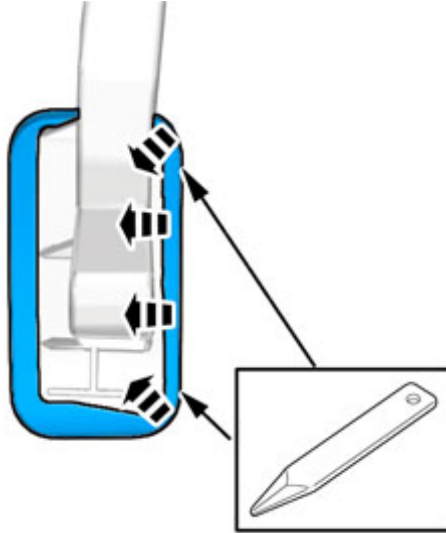

IMG-357386

10

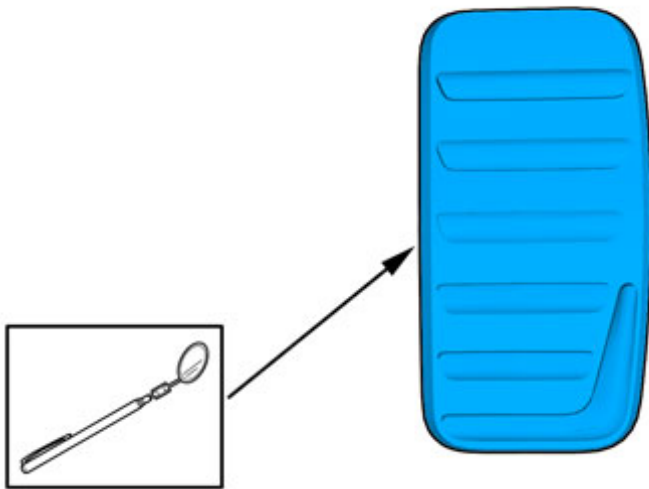

IMG-357377

**Caution!**  
Using a mirror check that the pedal rubber covers the edges of the pedal.

Cars with automatic transmissions



# Installation instructions, accessories

Volvo Car Corporation Gothenburg, Sweden

11

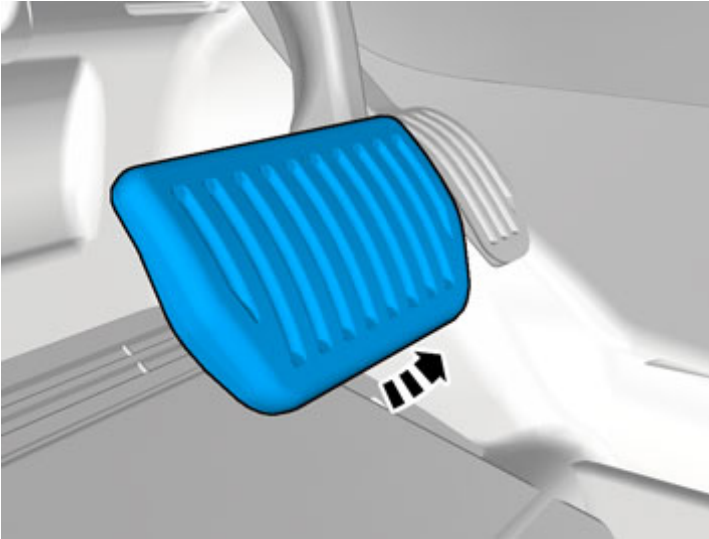

IMG-339856

The part is not to be reused.

12

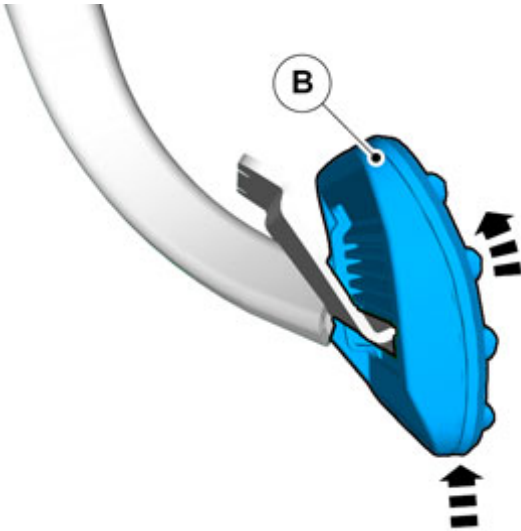

IMG-358417

Hook the pedal rubber onto the pedal at the lower edge and pull the pedal rubber upward.

# Installation instructions, accessories

Volvo Car Corporation Gothenburg, Sweden

13

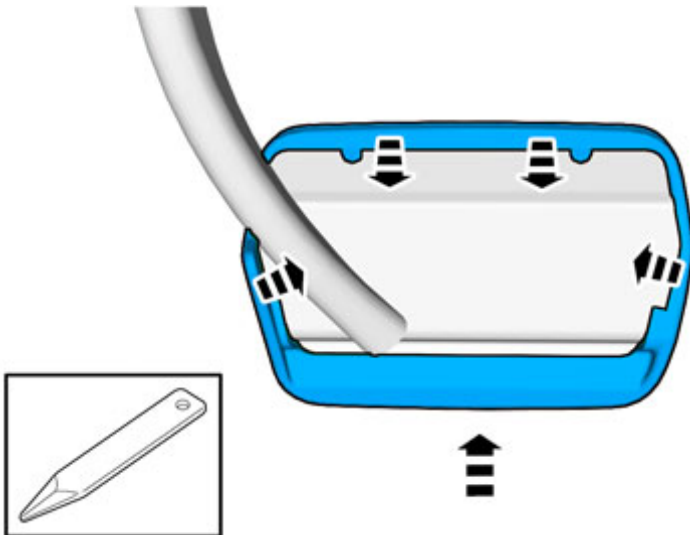

IMG-358418

Press the pedal rubber towards the pedal and at the same time fold the pedal rubber's profile over the pedal using a straightening tool.

14

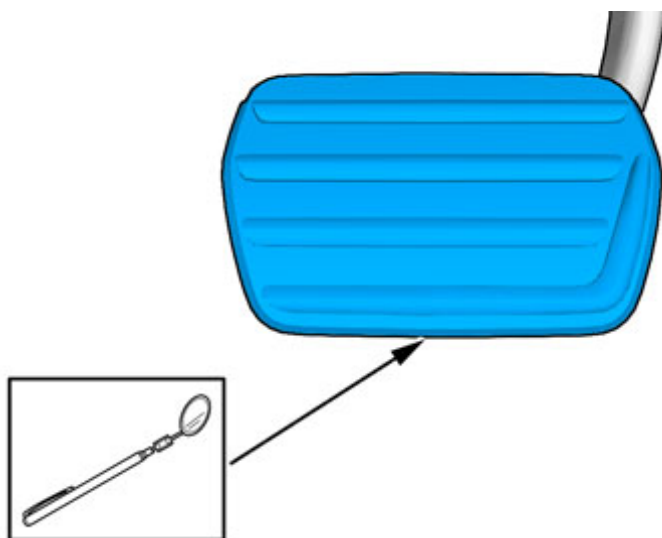

IMG-357413

**Caution!**

Using a mirror check that the pedal rubber covers the edges of the pedal.

Cars with manual transmissions

# Installation instructions, accessories

Volvo Car Corporation Gothenburg, Sweden

15

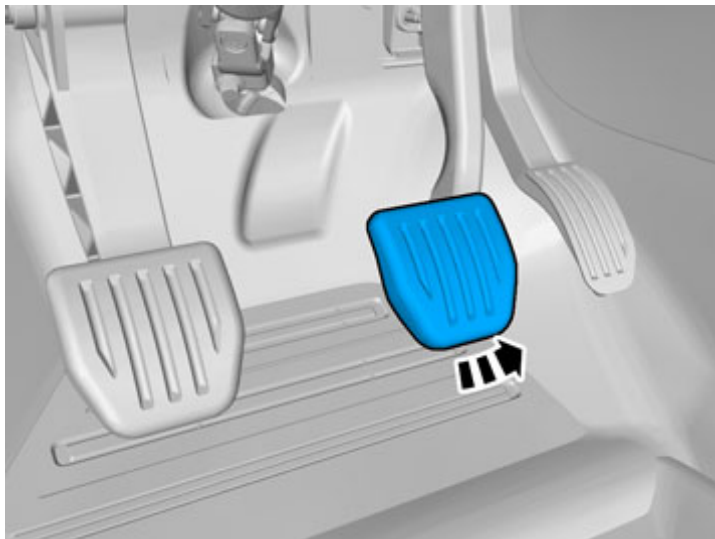

IMG-339858

The part is not to be reused.

16

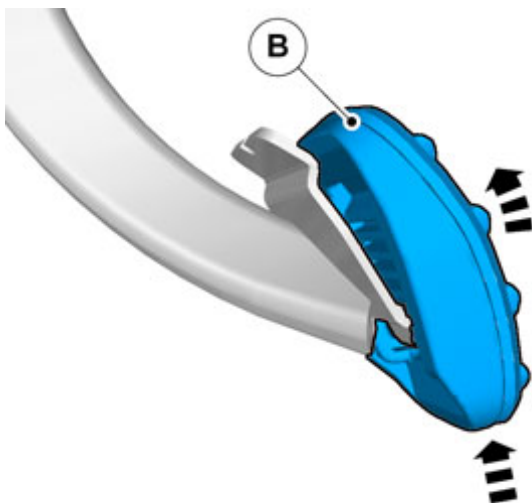

IMG-358420

Hook the pedal rubber onto the pedal at the lower edge and pull the pedal rubber upward.

# Installation instructions, accessories

Volvo Car Corporation Gothenburg, Sweden

17

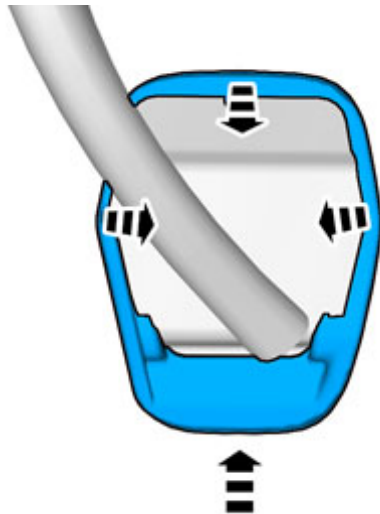

IMG-358419

Press the pedal rubber towards the pedal and at the same time fold the pedal rubber's profile over the pedal using a straightening tool.

18

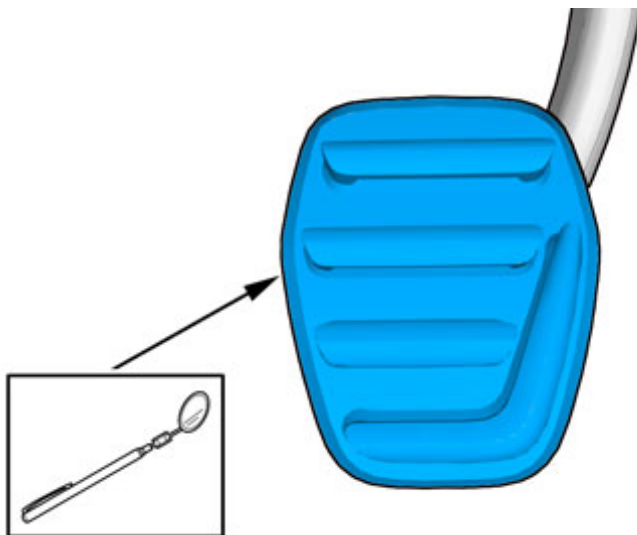

IMG-358075

**Caution!**

Using a mirror check that the pedal rubber covers the edges of the pedal.

**Left hand drive vehicles**

19

Repeat method steps for the clutch pedal.

**Right-hand drive vehicles**

# Installation instructions, accessories

Volvo Car Corporation Gothenburg, Sweden

20

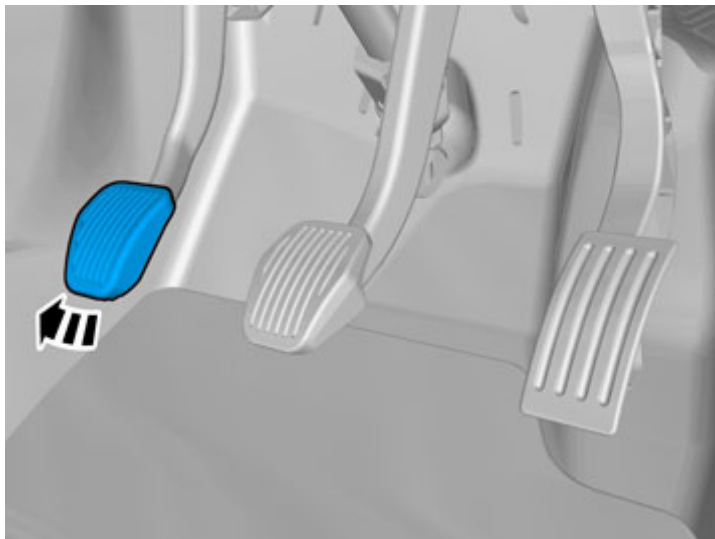

IMG-358152

The part is not to be reused.

21

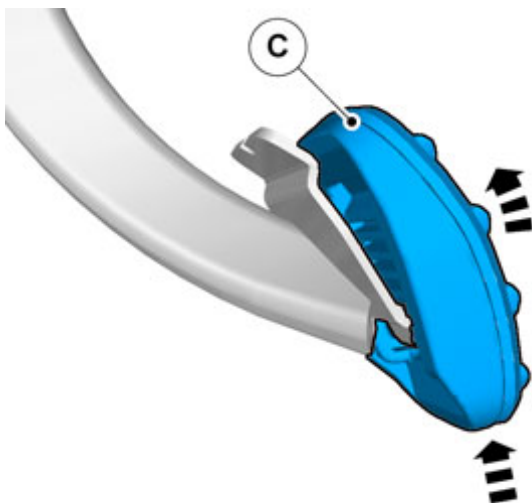

IMG-358421

Hook the pedal rubber onto the pedal at the lower edge and pull the pedal rubber upward.

# Installation instructions, accessories

Volvo Car Corporation Gothenburg, Sweden

22

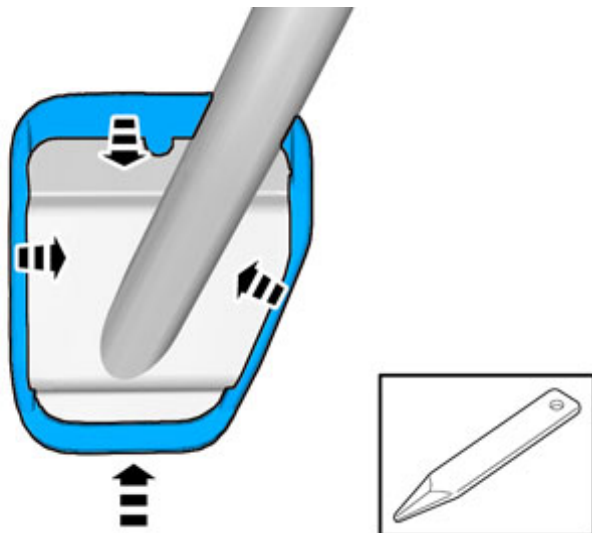

IMG-358156

Press the pedal rubber towards the pedal and at the same time fold the pedal rubber's profile over the pedal using a straightening tool.