

# Installation instructions, accessories

Volvo Car Corporation Gothenburg, Sweden

Instruction No	Version	Part. No.
31265296	1.3	39820264, 39820262, 39820260, 39814567, 39802126, 39802132, 39802130, 39802128, 39802122, 39802120, 39802118, 39802116, 39802114, 39802112, 39802108, 39802106, 39802104, 39802102, 39802100, 39802098

## Spoiler, boot lid



IMG-340286

### Equipment

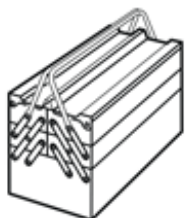

A0000162



IMG-239660



**VOLVO**  
**9512942**

IMG-337358



IMG-239667



IMG-239663

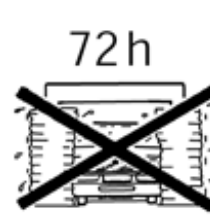

72h

IMG-251688



1h

# Installation instructions, accessories

Volvo Car Corporation Gothenburg, Sweden

IMG-332314

IMG-254087

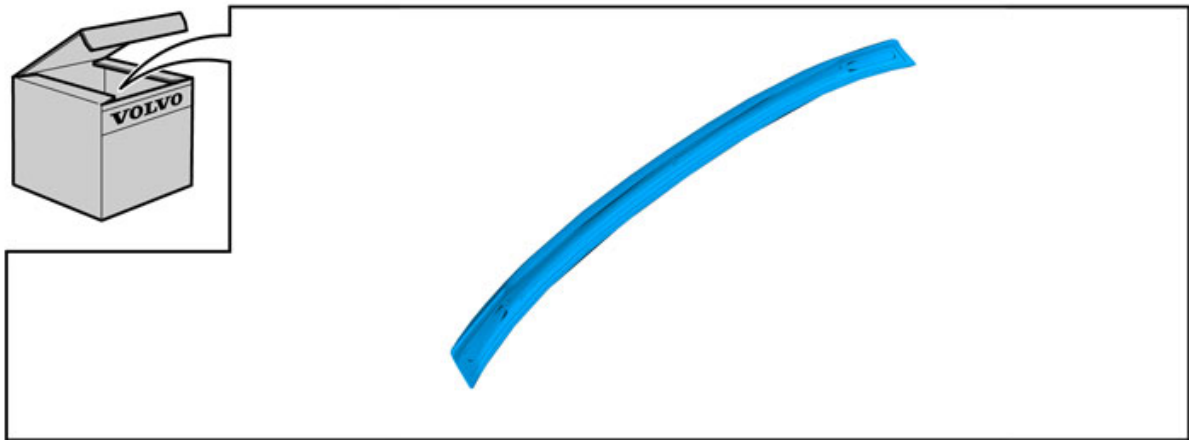

IMG-340287

# Installation instructions, accessories

Volvo Car Corporation Gothenburg, Sweden

## INTRODUCTION

Read through all of the instructions before starting installation.

Notifications and warning texts are for your safety and to minimise the risk of something breaking during installation.

Ensure that all tools stated in the instructions are available before starting installation.

Certain steps in the instructions are only presented in the form of images. Explanatory text is also given for more complicated steps.

In the event of any problems with the instructions or the accessory, contact your local Volvo dealer.

### Note!

Do not carry out work at temperatures below 20°C(68°F). Do not use the vehicle within 1 hour of carrying out the work.

### Note!

Do not wash the vehicle within 72 hours after doing the work.

## Preparations

1

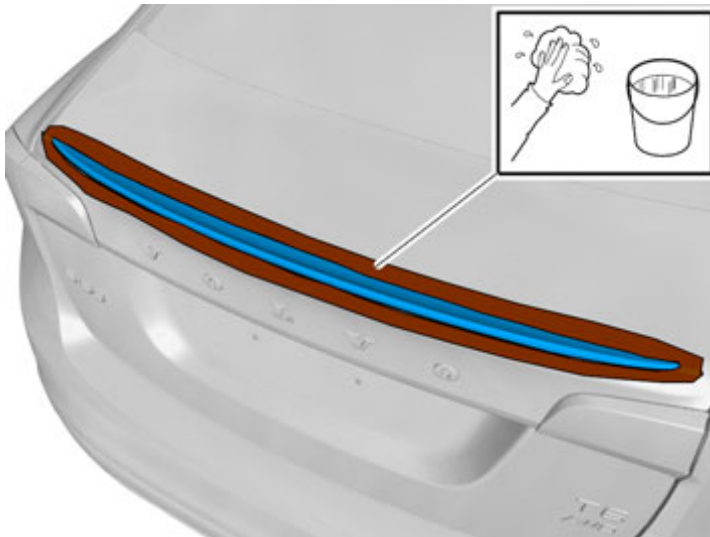

IMG-344561

### Preparations

#### Applies to cars with standard spoiler

Clean around the spoiler.

Wipe dry.

# Installation instructions, accessories

Volvo Car Corporation Gothenburg, Sweden

2

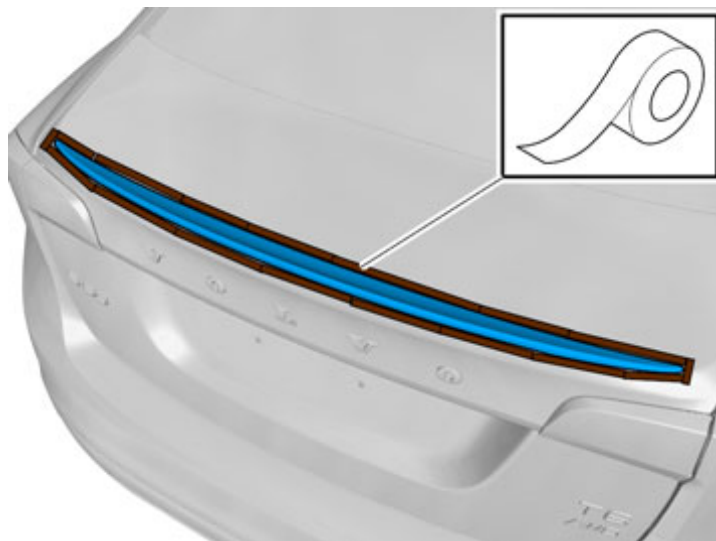

IMG-344560

Tape around the spoiler.

3

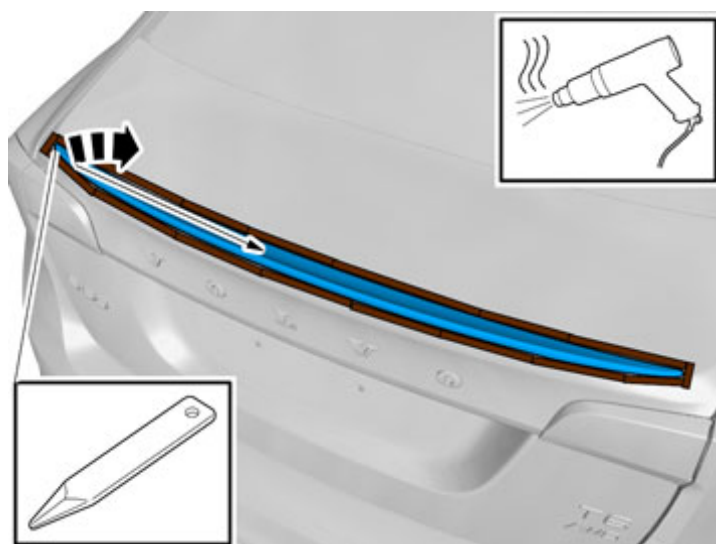

IMG-344558

Heat around the edges of the spoiler and carefully pry it off using a weatherstrip tool. Do not damage painted surfaces.

# Installation instructions, accessories

Volvo Car Corporation Gothenburg, Sweden

4



IMG-344557

Remove the masking tape.

5



IMG-344559

Remove any tape residue: Use circular grinding tool **part no. 9512942** installed on the drill.

# Installation instructions, accessories

Volvo Car Corporation Gothenburg, Sweden

6

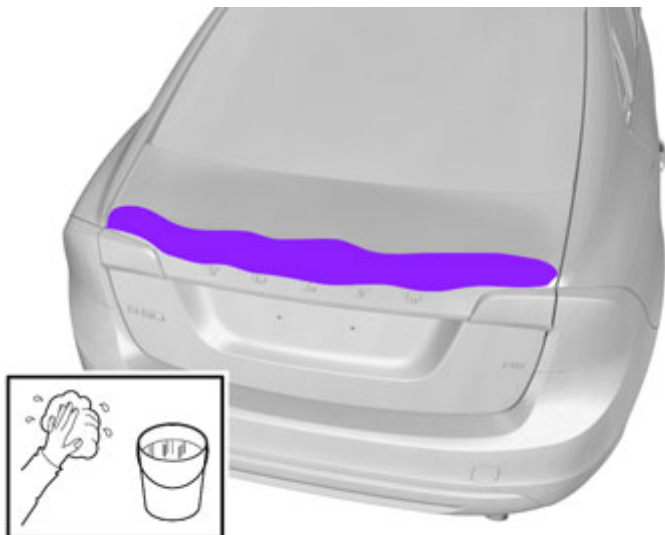

IMG-340296

**Applies to all models**

Clean the marked area on the boot lid.

Wipe dry.

7

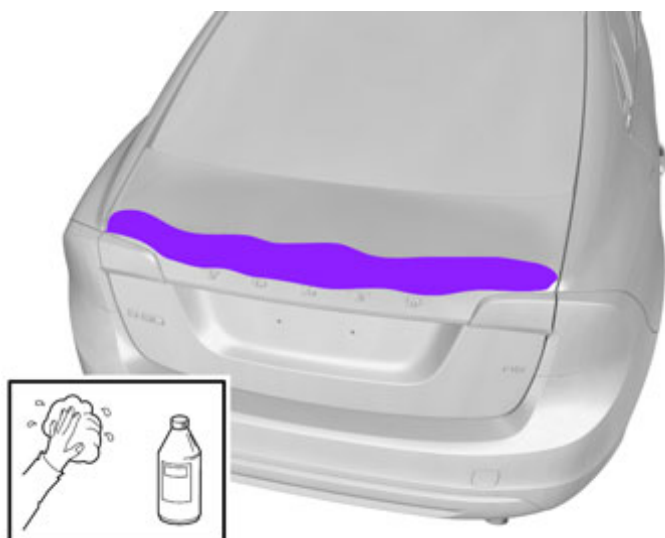

IMG-340486

Clean the marked area on the boot lid using isopropanol.

Wipe dry.

# Installation instructions, accessories

Volvo Car Corporation Gothenburg, Sweden

8

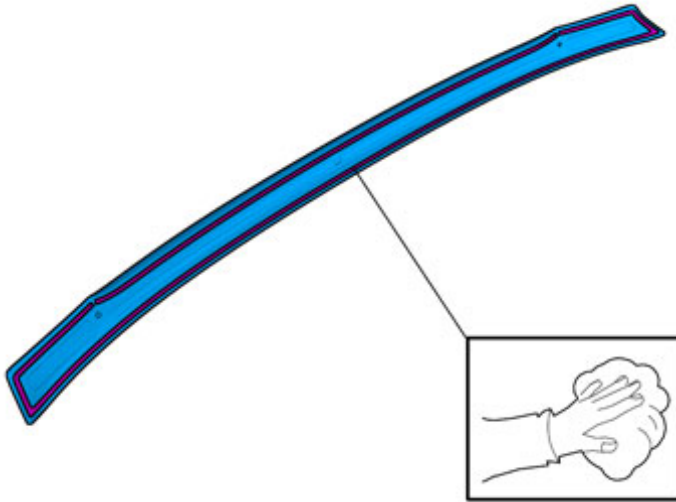

Wipe clean the protective tape on the spoiler's attachment tape before marking up on the boot lid.

IMG-340294

9

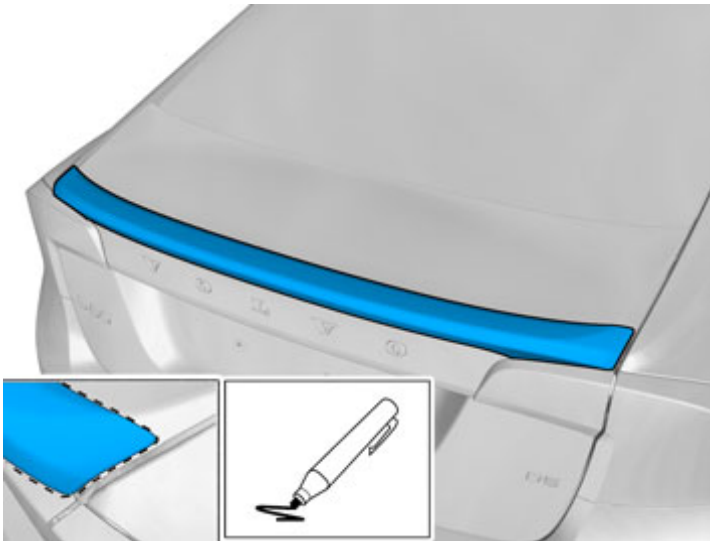

**Note!**

Get help from a colleague for this procedure.

Position and centre the spoiler on the boot lid panel.

Mark its position laterally and longitudinally using a white-board marker.

IMG-340488

# Installation instructions, accessories

Volvo Car Corporation Gothenburg, Sweden

10

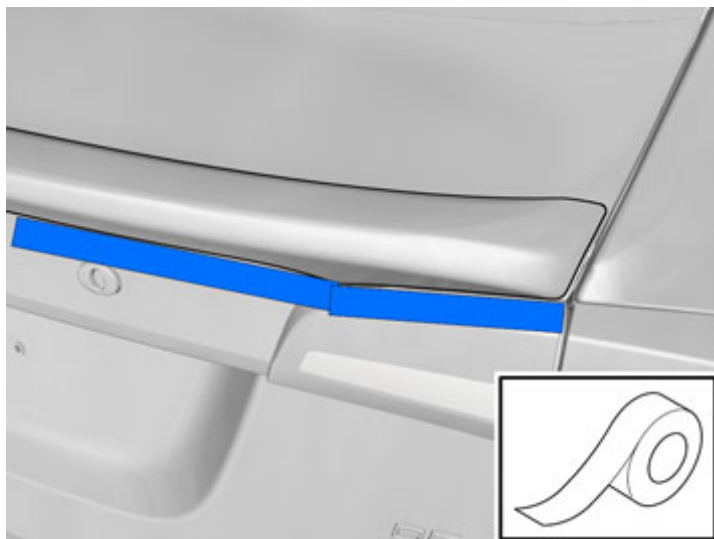

IMG-340489

Remove the spoiler and tape along the marking on the boot lid's rear edge to prevent primer spillage. Fold up the lower edge of the tape so that any excess primer ends up there.



# Installation instructions, accessories

Volvo Car Corporation Gothenburg, Sweden

11A

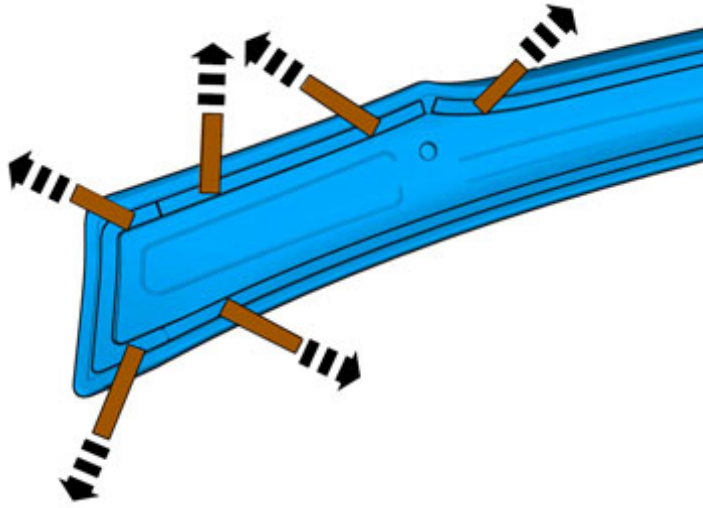

IMG-340289

11B

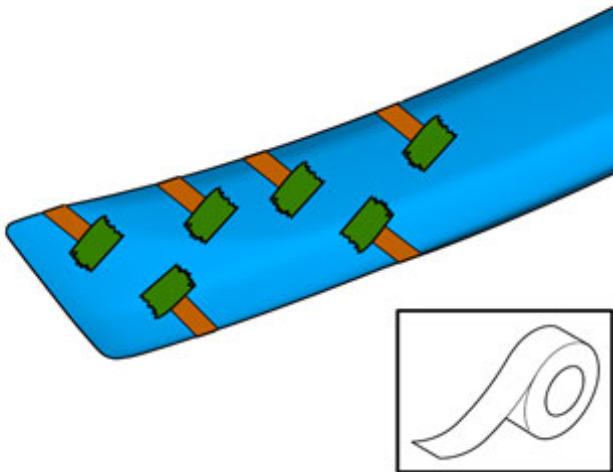

IMG-340293

## Illustrations A and B

Detach the backing tape from the attaching tape on both sides, fold it up and secure it using a piece of tape on top of the spoiler.

# Installation instructions, accessories

Volvo Car Corporation Gothenburg, Sweden

12A

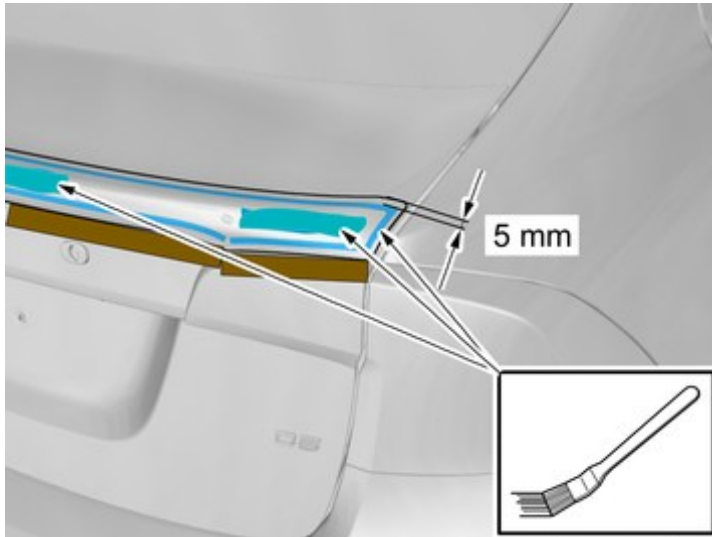

## Illustrations A and B

Apply a bead of primer to the boot lid, **5 mm (13/64")** within the markings, and the wider area on both ends and in the centre of the boot lid. Ensure that primer does not get on other surfaces, if so, clean with isopropanol.

Apply primer within the markings at the sides of the spoiler and in the centre.

12B

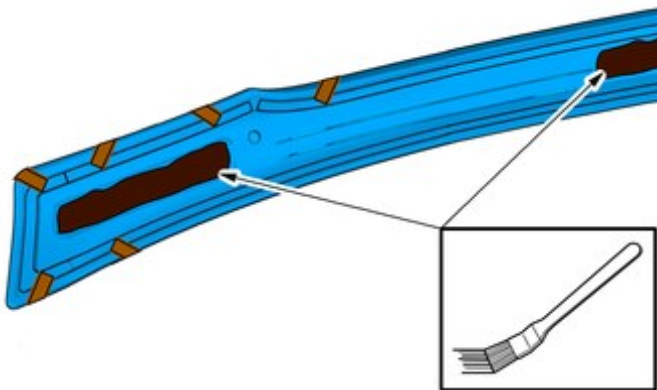

13

10min

Allow the primer to dry for 10 minutes.



J8401215

# Installation instructions, accessories

Volvo Car Corporation Gothenburg, Sweden

14A

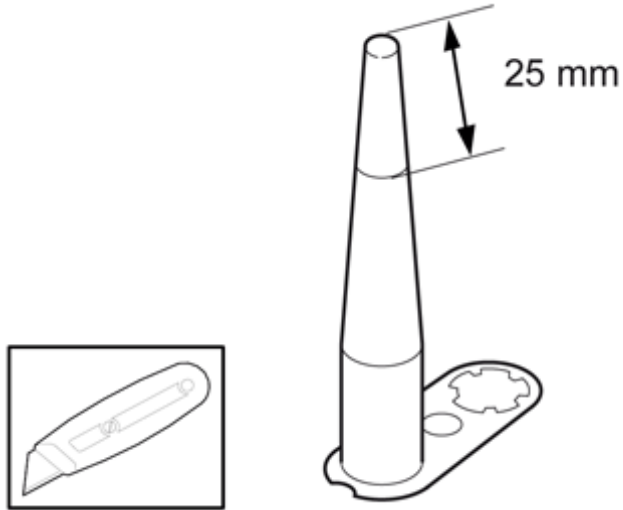

IMG-340712

14B

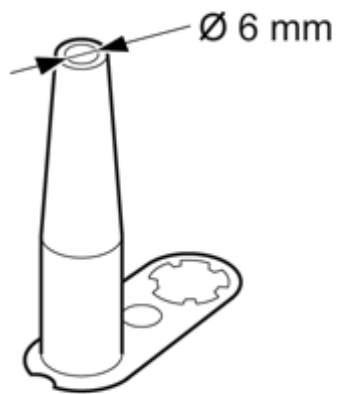

IMG-340713

## Illustrations A and B

Cut off the nozzle so that the inner diameter becomes approx. 6 mm.

15

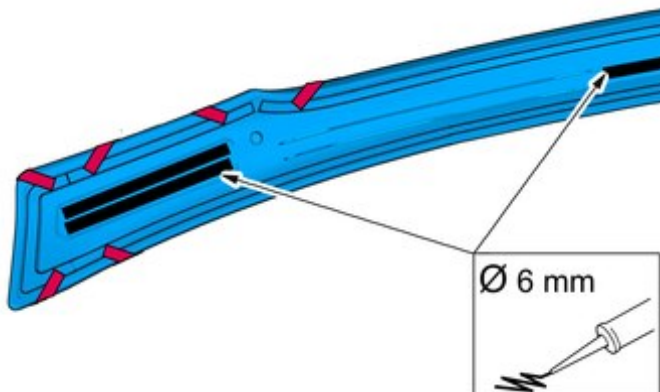

IMG-340501

Apply adhesive to the marked areas on both sides of the spoiler and in the centre.

# Installation instructions, accessories

Volvo Car Corporation Gothenburg, Sweden

16

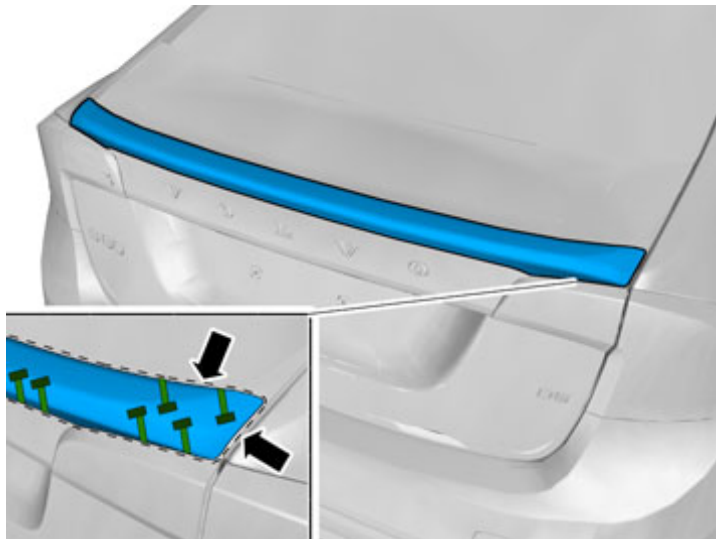

IMG-340506

Remove the tape from the rear edge of the boot lid.

### Hint

Two mechanics are needed for steps 17-18.

Move the spoiler carefully down towards the boot lid. Place it edge-to-edge at the start of the marking on one side of the boot lid, and at the piece of tape at the front edge. Keep depressed.

17

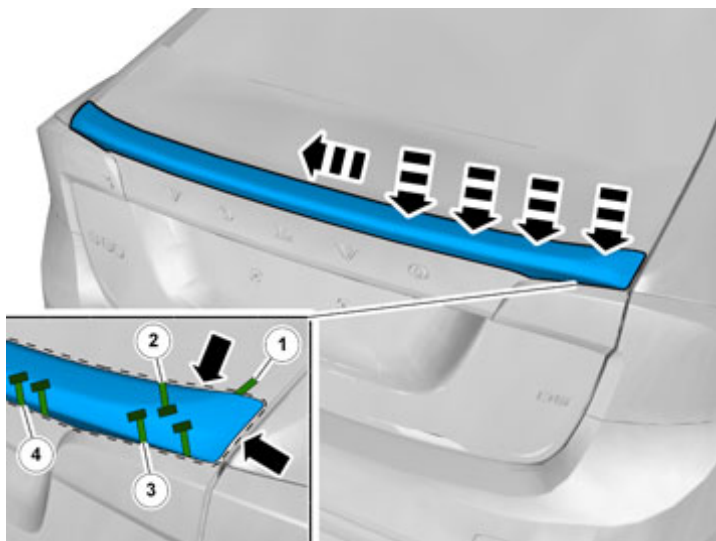

IMG-340507

Carefully pull off the spoiler's protective tape, maintaining the position of the spoiler. Start by pulling off the protective tape (1) on the ends first, then at the front edge (2), then the short rear (3) then the long rear (4).

Secure the spoiler as the protective tape is removed. Bend the spoiler so that it follows the markings on the boot lid at the front edge of the spoiler. Do not secure the spoiler too close to where the protective tape is pulled off. If the tape adheres, try to carefully pry the spoiler up slightly to make it easier to remove the protective tape.

# Installation instructions, accessories

Volvo Car Corporation Gothenburg, Sweden

18



IMG-340295

Press the spoiler so that the tape adheres properly.

Clean off the markings using isopropanol.