

# Installation instructions, accessories

Volvo Car Corporation Gothenburg, Sweden

Instruction No	Version	Part. No.
31330285	1.5	39823006, 39818009, 39822314, 31352530, 39818912, 39818007, 39817982, 39818006, 39818005, 39817991, 39817984, 39817983, 39817981, 39817980, 39817978, 39818920, 39814361, 39814363, 39822310, 39822311, 39822312, 39822313, 39818941, 39822315

## Deflector, side

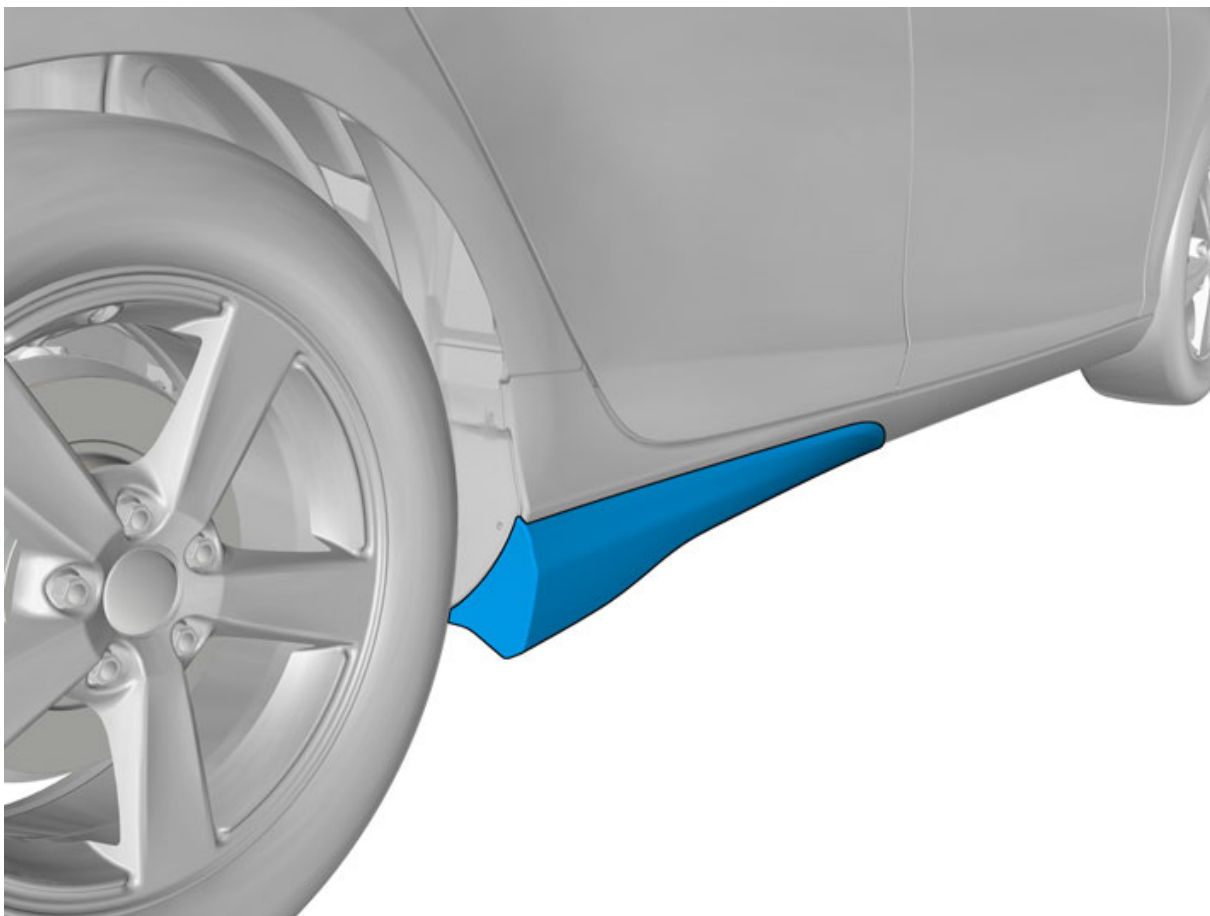

IMG-354753

### Materials

Designation	Part number
Isopropanol	1161721

### Equipment

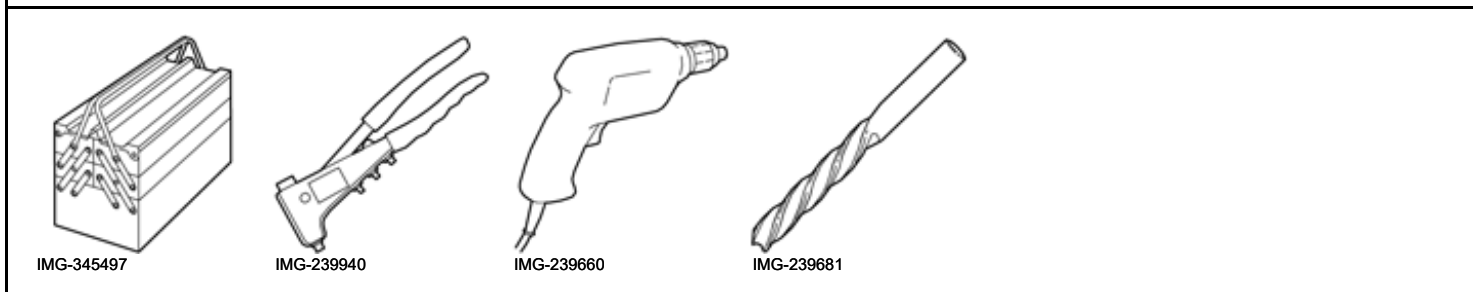

# Installation instructions, accessories

Volvo Car Corporation Gothenburg, Sweden

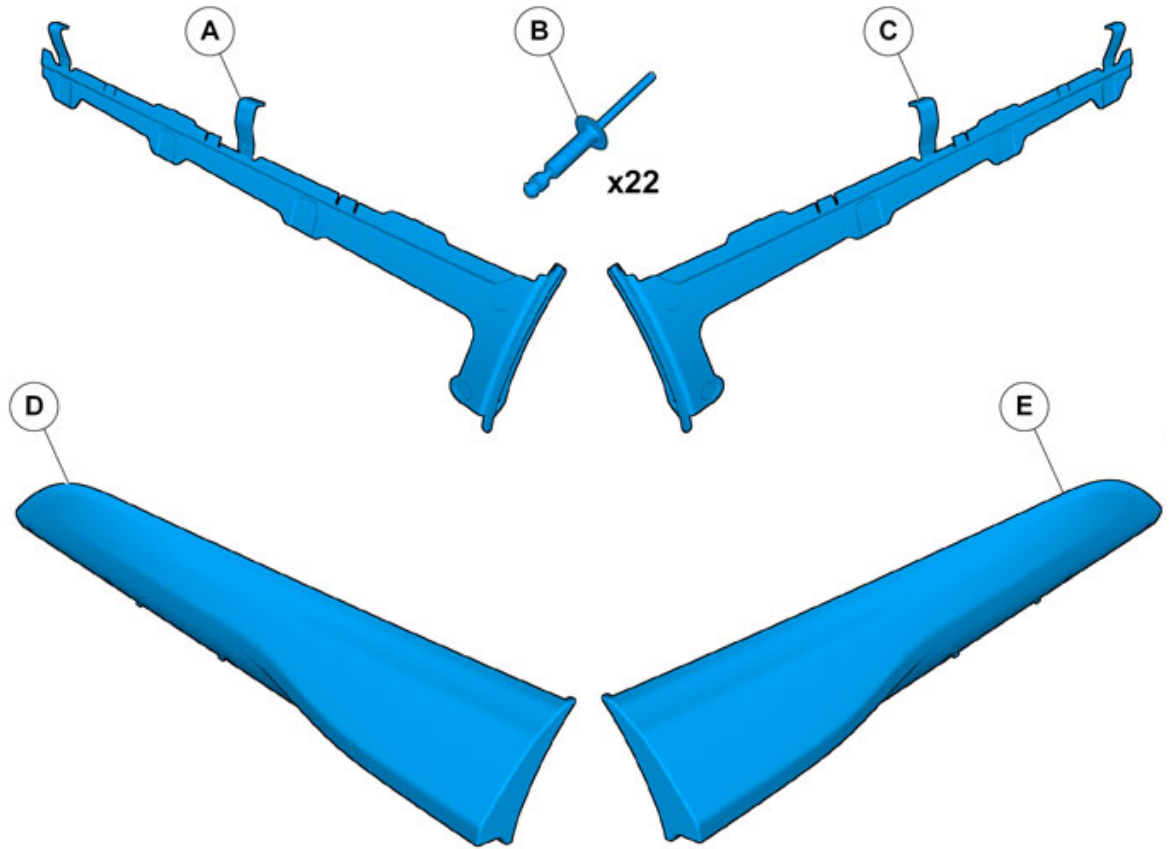

IMG-370733

# Installation instructions, accessories

Volvo Car Corporation Gothenburg, Sweden

---

## Information

---

1

Read through all of the instructions before starting installation.

Notifications and warning texts are for your safety and to minimise the risk of something breaking during installation.

Ensure that all tools stated in the instructions are available before starting installation.

Certain steps in the instructions are only presented in the form of images. Explanatory text is also given for more complicated steps.

In the event of any problems with the instructions or the accessory, contact your local Volvo dealer.

---

## Color symbols

---

2

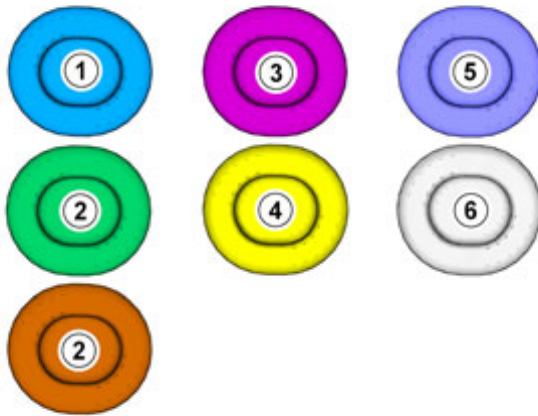

IMG-363036

### Note!

This colour chart displays (in colour print and electronic version) the importance of the different colours used in the images of the method steps.

1. Used for focused component, the component with which you will do something.
  2. Used as extra colors when you need to show or differentiate additional parts.
  3. Used for attachments that are to be removed/installed. May be screws, clips, connectors, etc.
  4. Used when the component is not fully removed from the vehicle but only hung to the side.
  5. Used for standard tools and special tools.
  6. Used as background color for vehicle components.
- 

## Removal

---

# Installation instructions, accessories

Volvo Car Corporation Gothenburg, Sweden

3

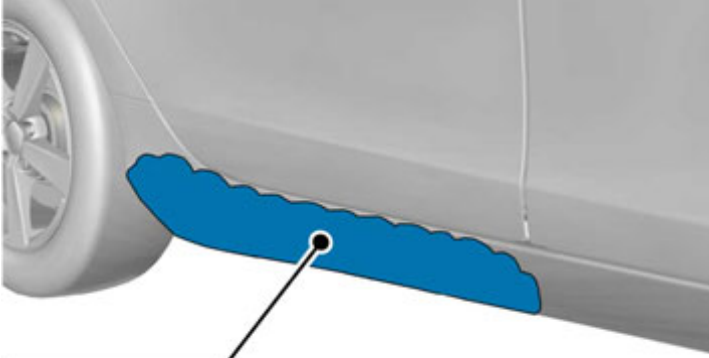

IMG-354777

Clean the surface.

**Use:** 1161721, Isopropanol

4

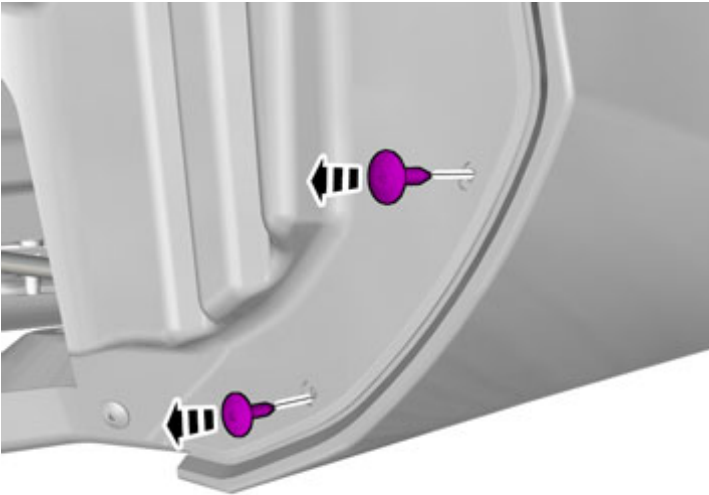

IMG-354778

Remove the screws.

5

Repeat the steps when removing on opposite side.

**Accessory installation**

# Installation instructions, accessories

Volvo Car Corporation Gothenburg, Sweden

6

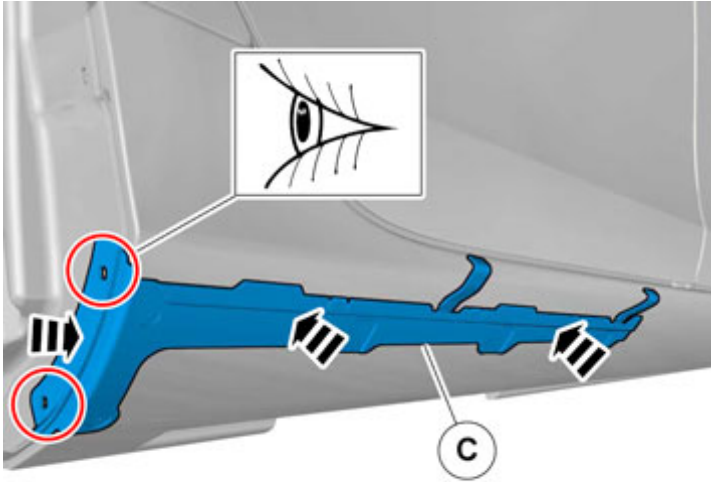

IMG-354801

7

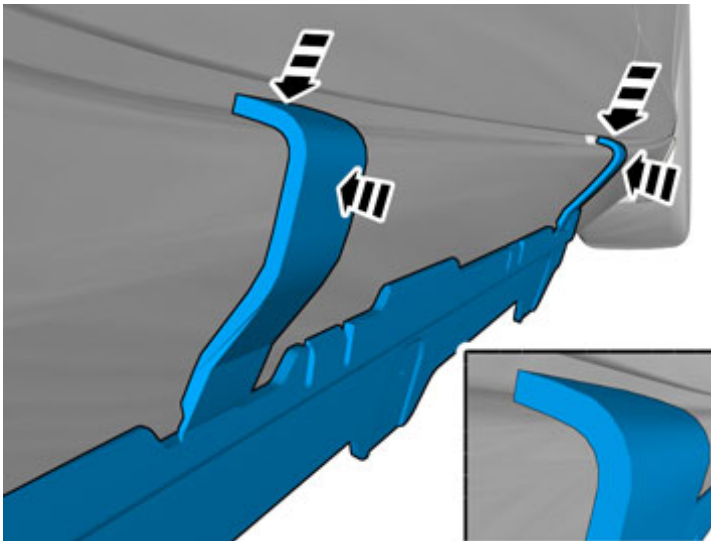

IMG-354817

# Installation instructions, accessories

Volvo Car Corporation Gothenburg, Sweden

8

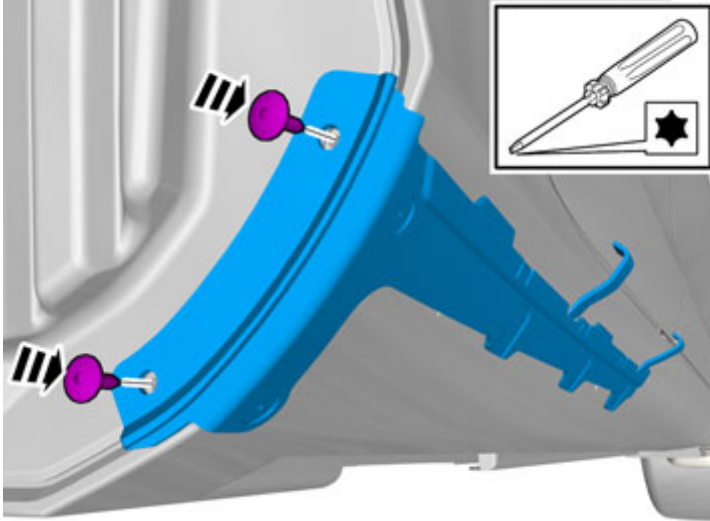

IMG-354802

Reinstall the screws.

9

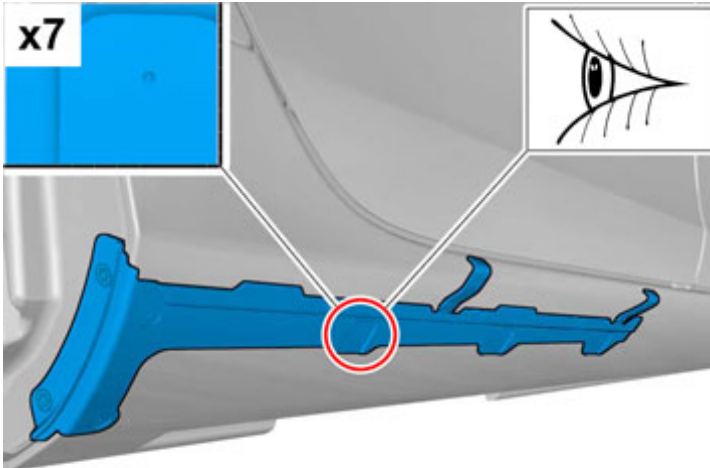

IMG-354803

Locate the markings for the positions.

# Installation instructions, accessories

Volvo Car Corporation Gothenburg, Sweden

10

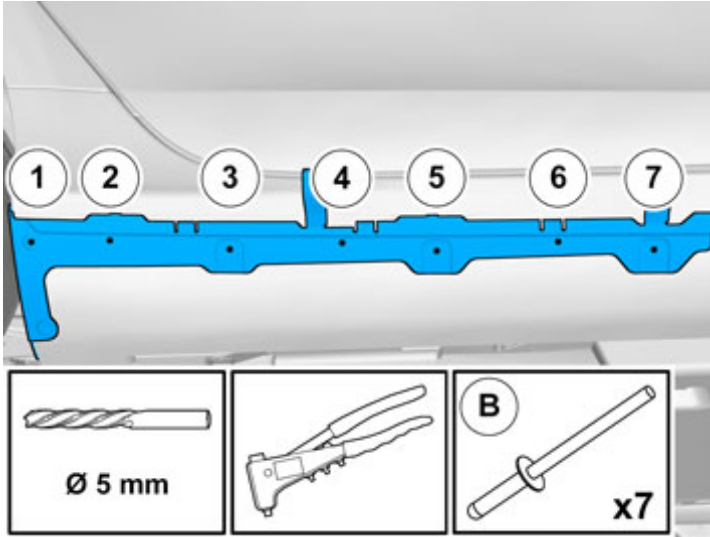

IMG-370716

Drill one hole and fit one pop rivet at a time, in accordance with the sequence illustrated.

11

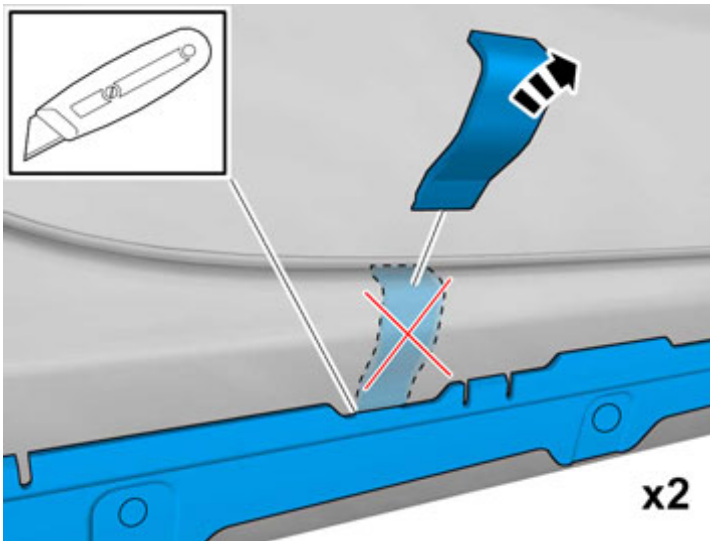

IMG-354861

# Installation instructions, accessories

Volvo Car Corporation Gothenburg, Sweden

12

Fold the protective film forward

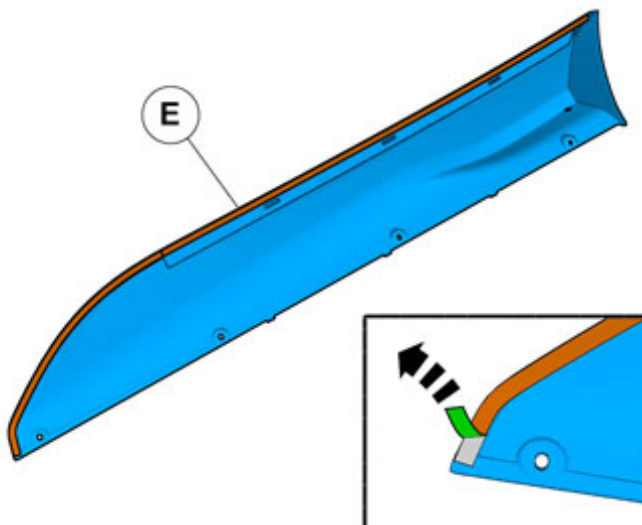

IMG-370721

13

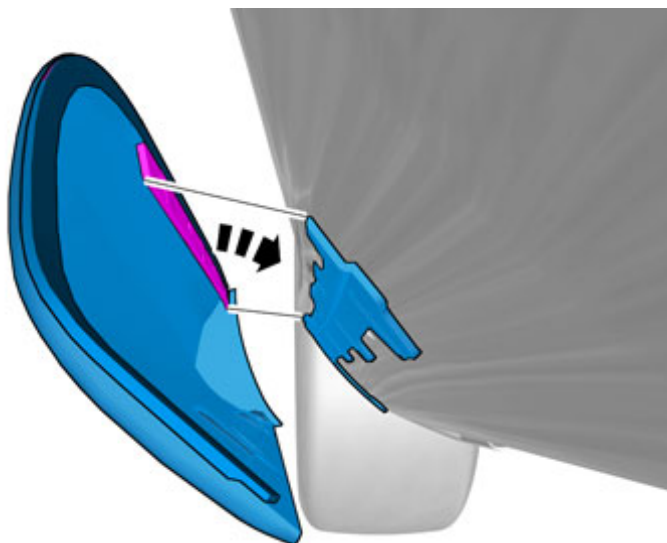

IMG-354892



# Installation instructions, accessories

Volvo Car Corporation Gothenburg, Sweden

14

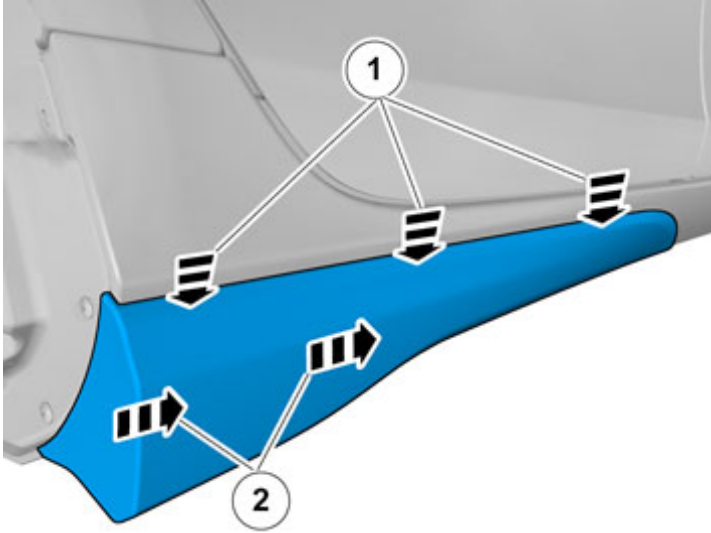

IMG-355987

15

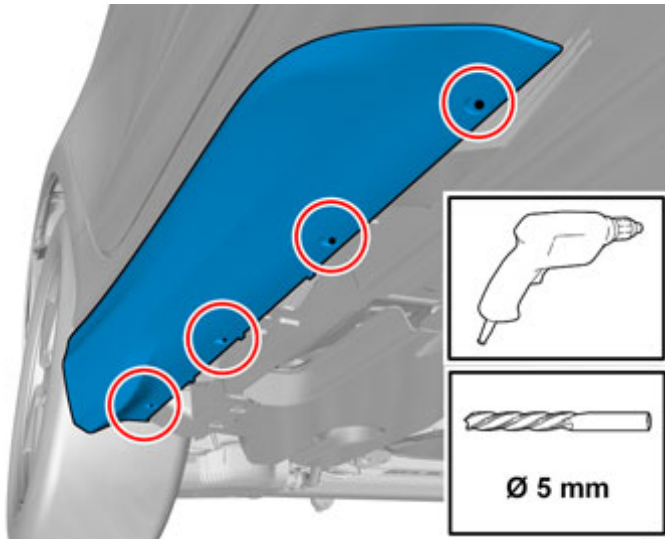

Drill the holes.

IMG-354899

# Installation instructions, accessories

Volvo Car Corporation Gothenburg, Sweden

16

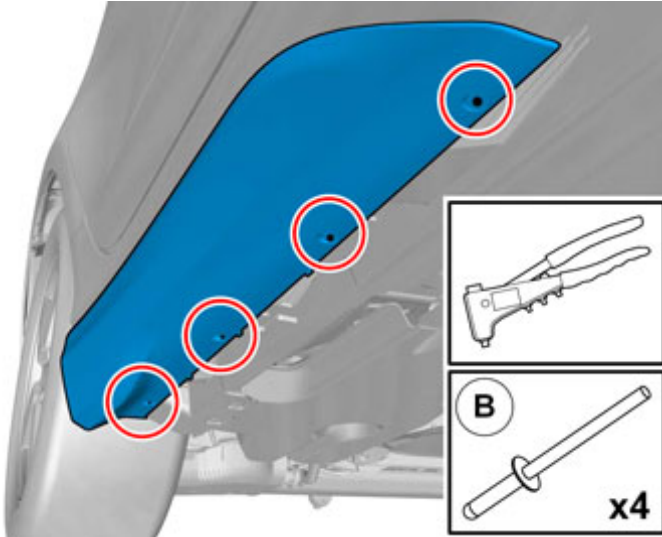

IMG-354900

17

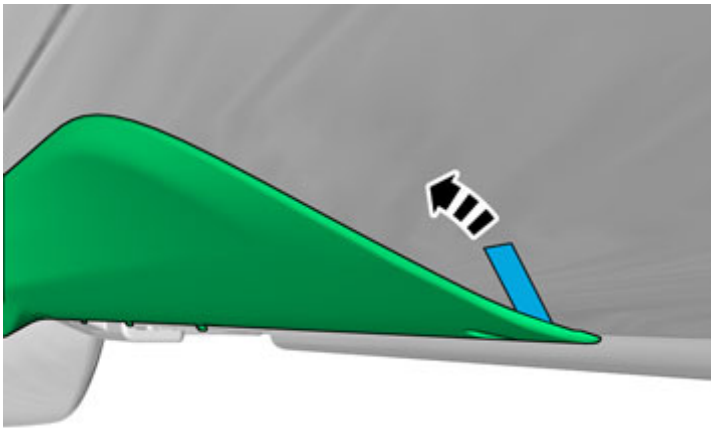

IMG-370722

**Caution!**  
Pull carefully.

Remove the protective film.

# Installation instructions, accessories

Volvo Car Corporation Gothenburg, Sweden

18

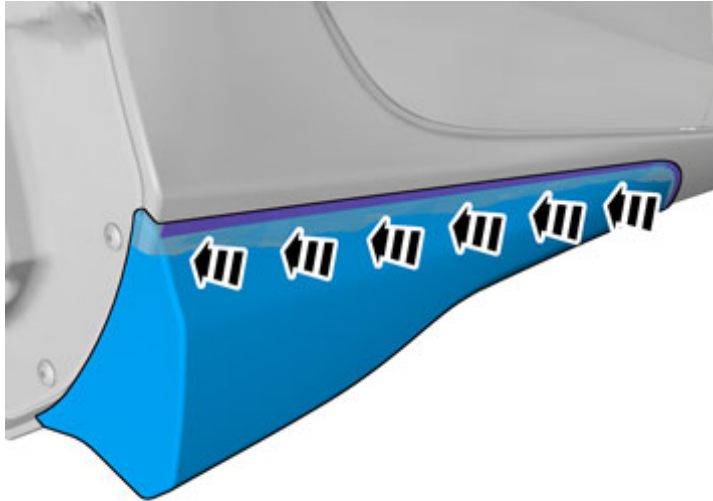

IMG-354903

**Caution!**

Make sure that equal pressure is applied to the full length of the component.

**Note!**

Ensure that the tape is fixed to the surface.

19

Repeat the steps when installing accessories on opposite side.