

Installation instructions, accessories

Volvo Car Corporation Gothenburg, Sweden

Instruction No 30756433 **Version** 1.1 **Part. No.** 31295410, 31334457

Cruise control

Equipment

VIDA

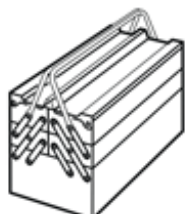

IMG-242205

A0000162

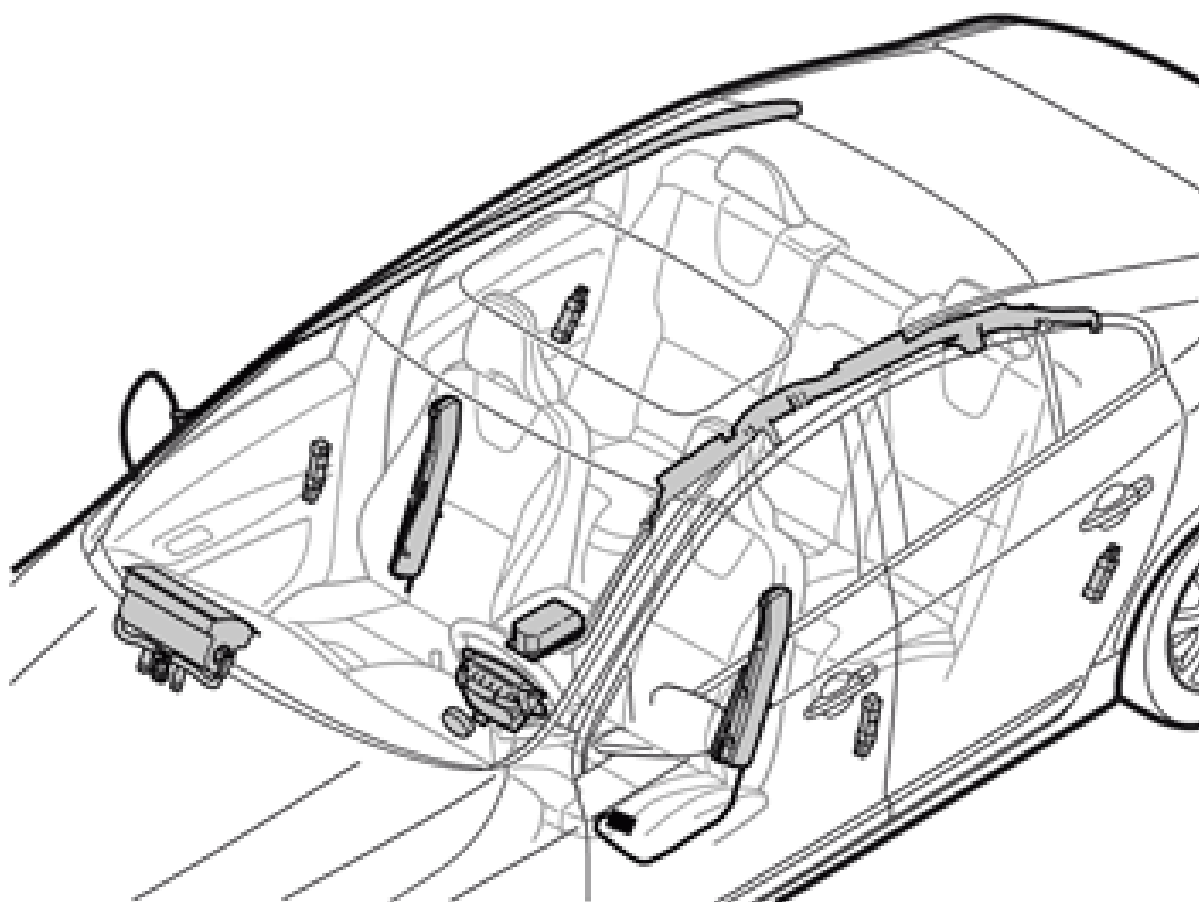

IMG-337681

Installation instructions, accessories

Volvo Car Corporation Gothenburg, Sweden

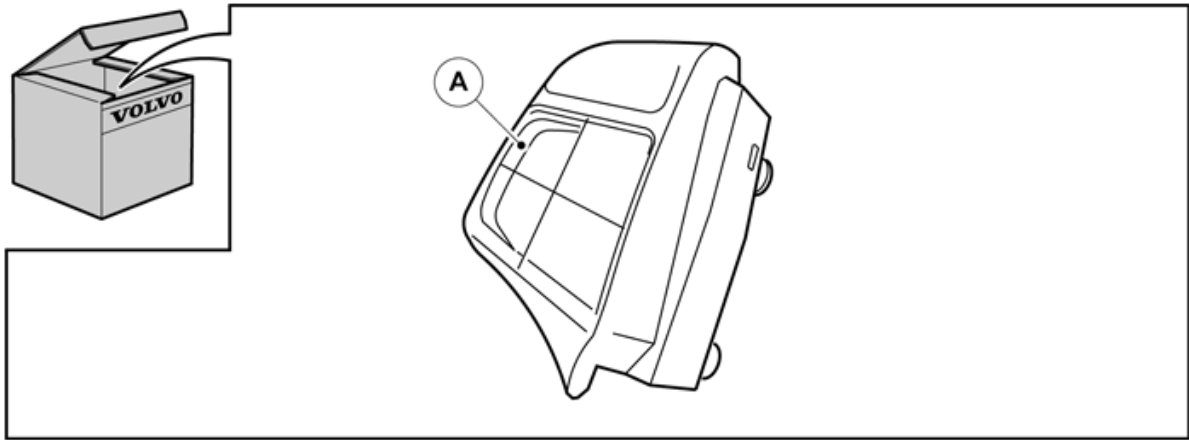

IMG-344778

Installation instructions, accessories

Volvo Car Corporation Gothenburg, Sweden

INTRODUCTION

Read through all of the instructions before starting installation.

Notifications and warning texts are for your safety and to minimise the risk of something breaking during installation.

Ensure that all tools stated in the instructions are available before starting installation.

Certain steps in the instructions are only presented in the form of images. Explanatory text is also given for more complicated steps.

In the event of any problems with the instructions or the accessory, contact your local Volvo dealer.

Warning!

A pyrotechnic SRS component must not be unscrewed, repaired or transferred to another vehicle.

When temporarily storing the driver's airbag (SRS) it must be positioned with the metal side (reverse side) down in a well protected site. This is to prevent damage to the surface material.

1

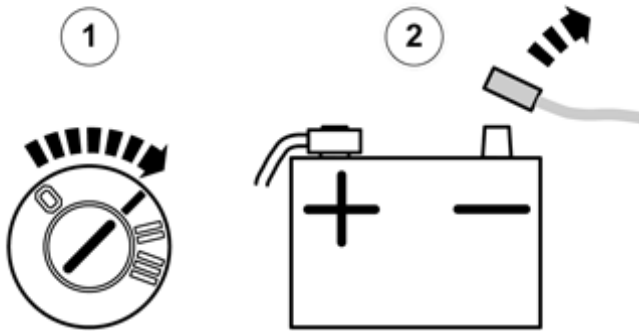

Set the ignition key to position I to release the steering wheel lock.

Disconnect the battery negative lead.

Note!

The SRS system remains active for a brief period after power is disconnected. Thus, wait three minutes before starting work.

IMG-332180

Installation instructions, accessories

Volvo Car Corporation Gothenburg, Sweden

2

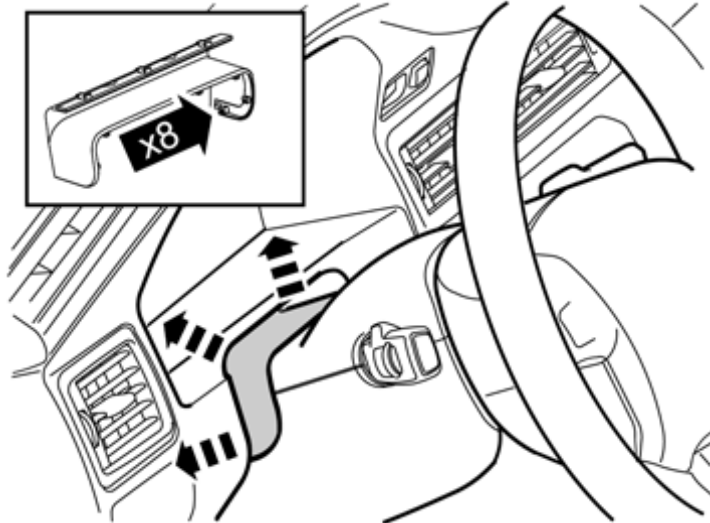

IMG-337651

Loosen the lever and pull the steering wheel console backwards.
Carefully prize off the rubber seal in the steering wheel cover all around.

3

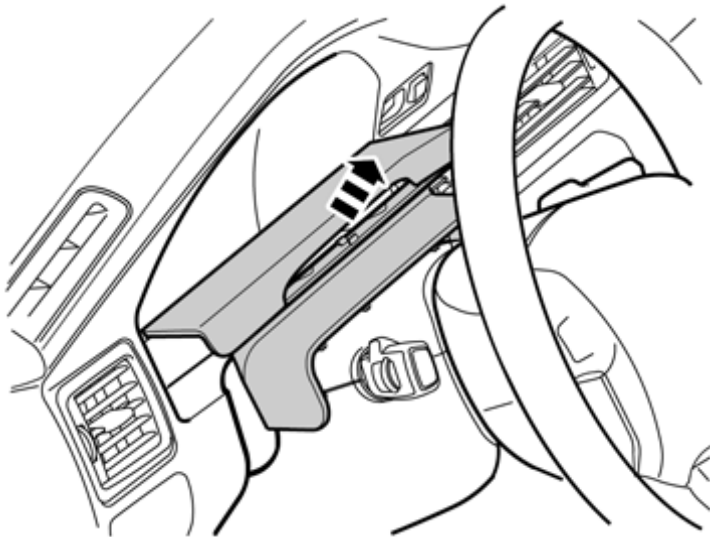

IMG-329034

Carefully pull it off and remove the panel with the rubber seal.

Installation instructions, accessories

Volvo Car Corporation Gothenburg, Sweden

4

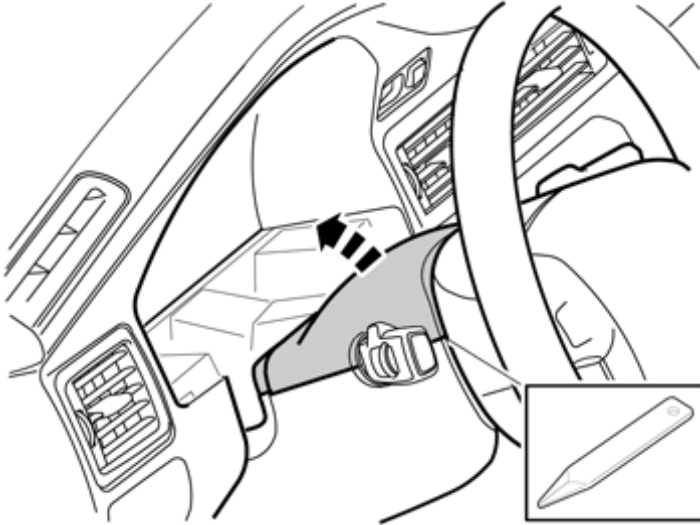

IMG-328978

Carefully prize off the upper cover from the lower one at the rear. Remove the cover. It is fitted with clips at the sides.

5

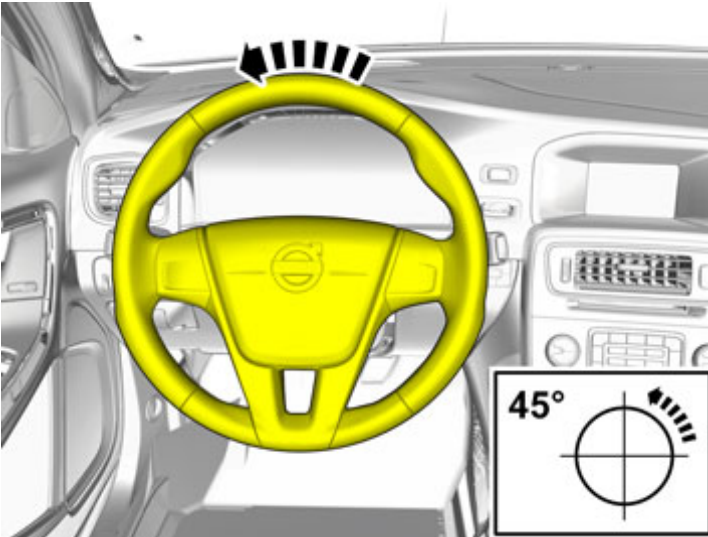

IMG-344116

Turn the knob to access the hole on the reverse of the steering wheel.

Installation instructions, accessories

Volvo Car Corporation Gothenburg, Sweden

6
mm

Use a 7 mm wide and 225 mm long screwdriver.

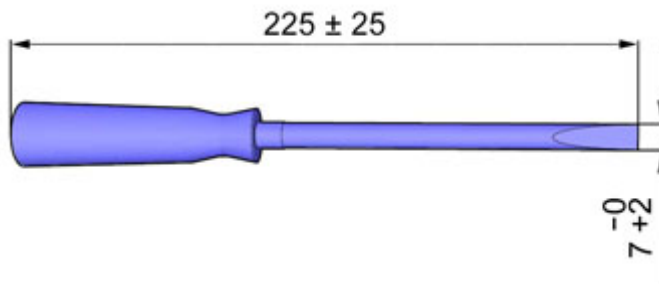

IMG-337683

7

Insert a screwdriver into the large hole on the rear of the steering wheel's rear face.

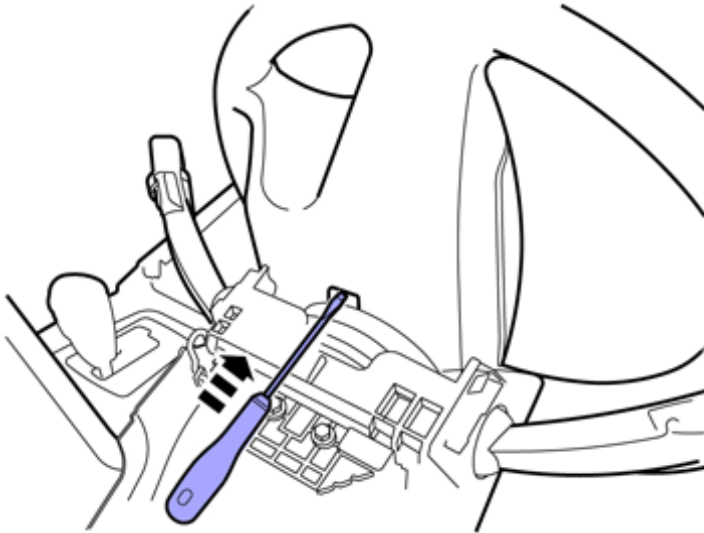

IMG-344725

Installation instructions, accessories

Volvo Car Corporation Gothenburg, Sweden

8

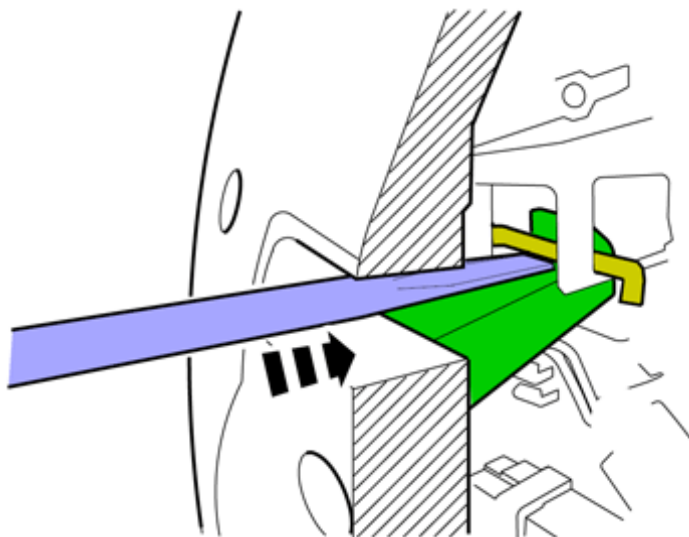

IMG-344726

Insert the tip of the screwdriver under the lock spring.

9

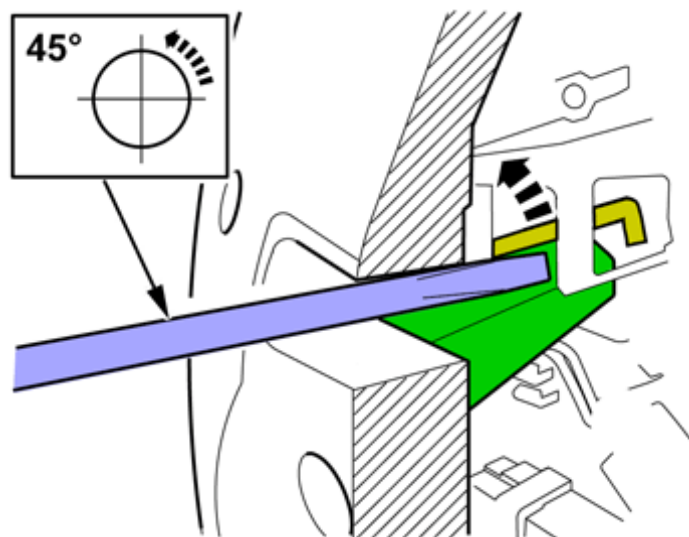

IMG-344727

Turn the screwdriver so that the end presses the lock spring up until it moves past the locking catch.

Installation instructions, accessories

Volvo Car Corporation Gothenburg, Sweden

10

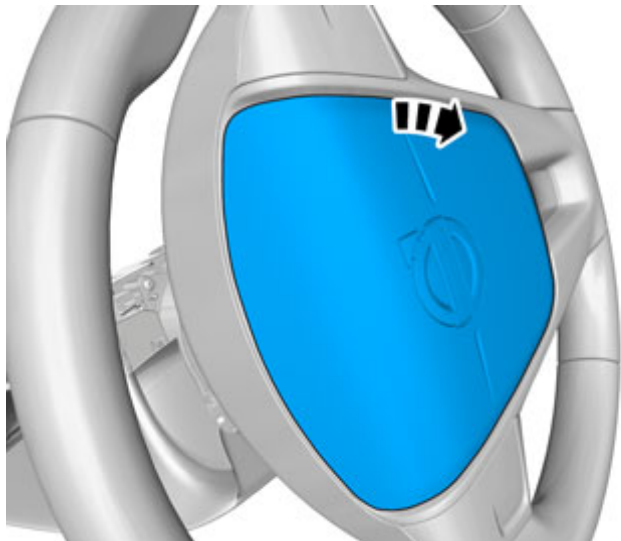

IMG-344117

Carefully pull off one side of the steering wheel module. It is firmly attached.

11

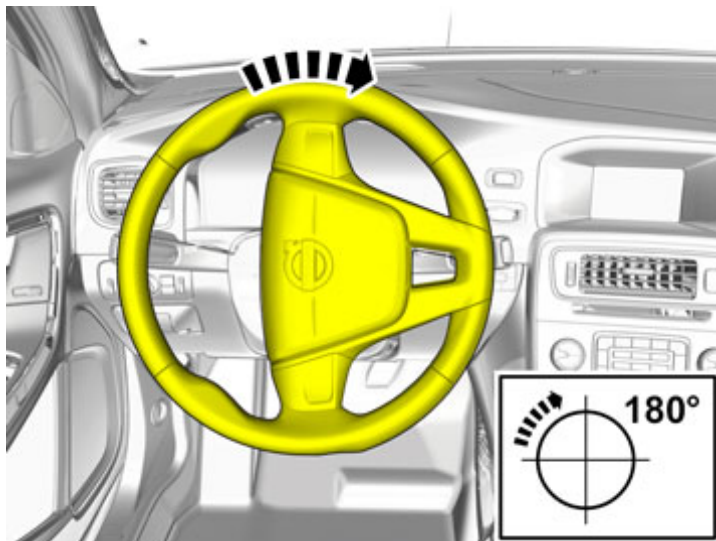

IMG-344118

Turn the steering wheel 180°.
Repeat for the lock spring on the other side.
Turn the steering wheel to neutral position.

Installation instructions, accessories

Volvo Car Corporation Gothenburg, Sweden

12

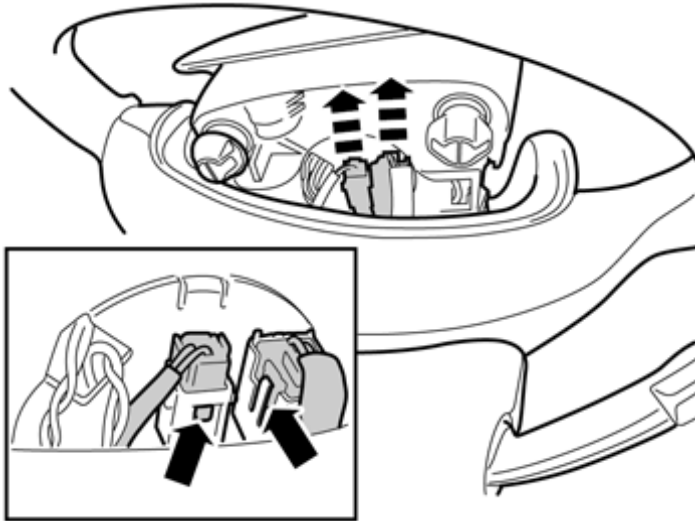

IMG-329003

Carefully fold back the steering wheel module so that the connectors in the upper edge are accessible.

Press in the catches on the connectors (small illustration) and detach them.

Place the steering wheel module to one side with the front side facing upwards in a suitable location.

13

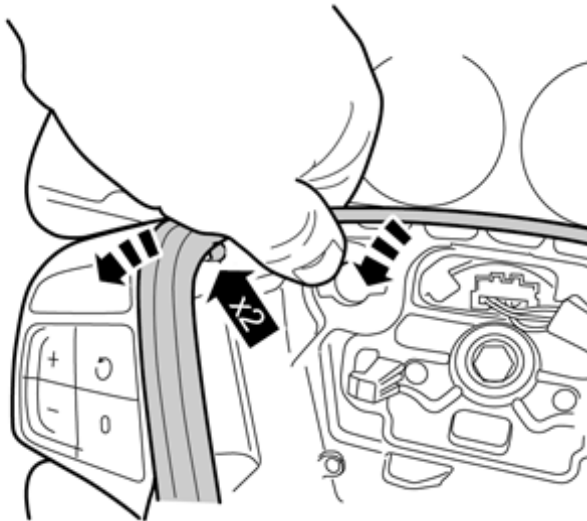

IMG-329005

Grip the panel in the upper left-hand corner and carefully pull it loose until the pin releases. Use both hands.

Repeat the operation on the other side.

Installation instructions, accessories

Volvo Car Corporation Gothenburg, Sweden

14

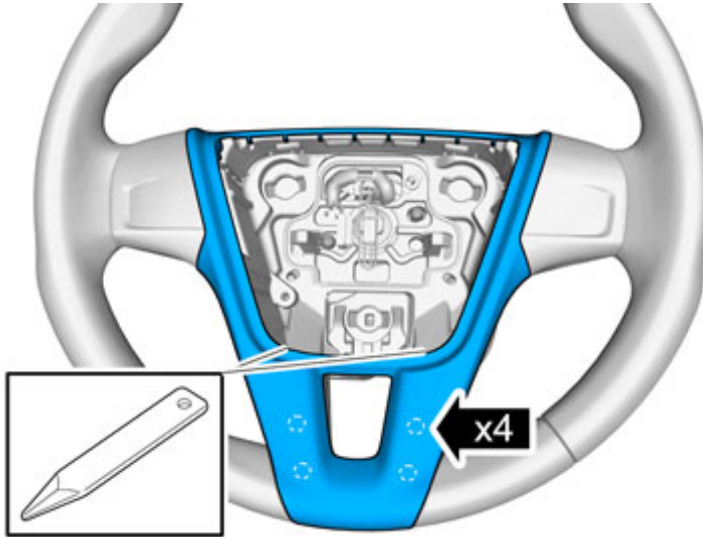

IMG-339674

Use a weatherstrip tool, turn and carefully pull the panel loose at the bottom on both sides.

15

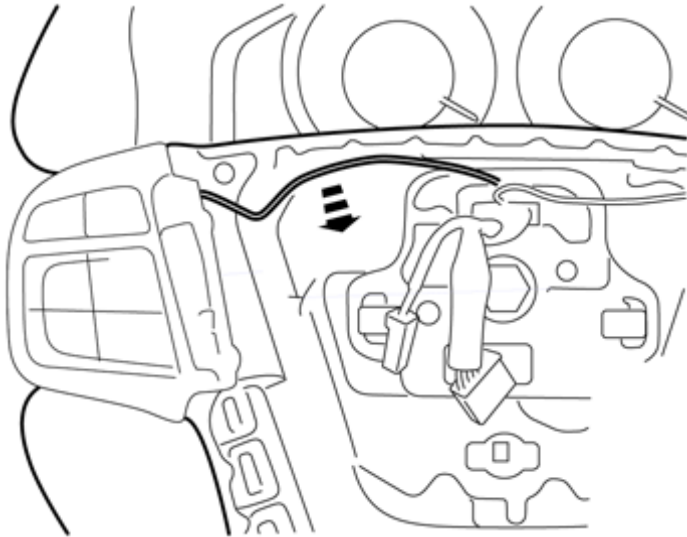

IMG-344119

Disconnect the cable to the keypad from its groove.

Installation instructions, accessories

Volvo Car Corporation Gothenburg, Sweden

16

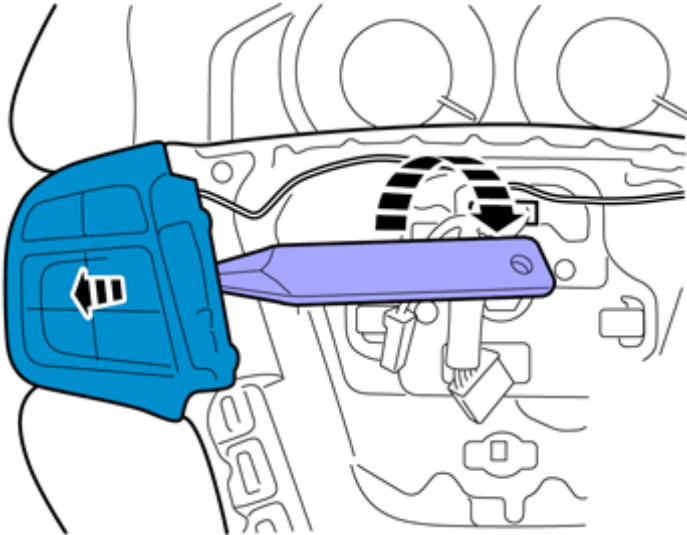

IMG-344120

Remove the right-hand keypad/keypad dummies by carefully prying them off using a weatherstrip tool.

Turn the weatherstrip tool to press out the keypad. It is firmly attached with three pins in the steering wheel, so force is required to remove them.

17

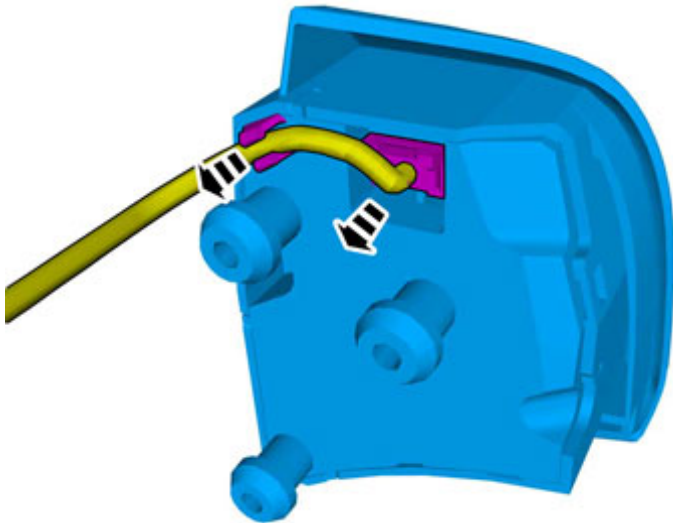

IMG-344121

Disconnect the cable and connector.

Installation instructions, accessories

Volvo Car Corporation Gothenburg, Sweden

18

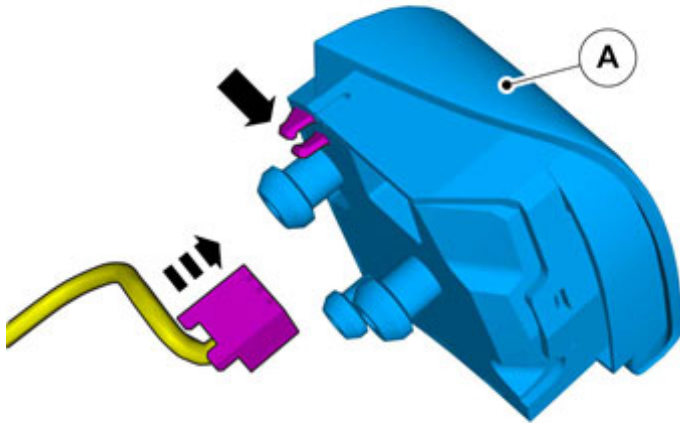

IMG-344122

19

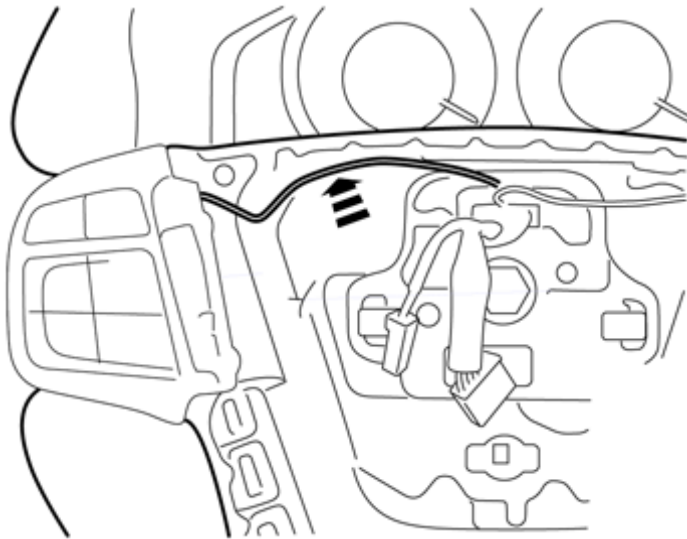

Place the cable in its groove.

IMG-344123

Installation instructions, accessories

Volvo Car Corporation Gothenburg, Sweden

20



IMG-339675

Reinstall the panel.

21

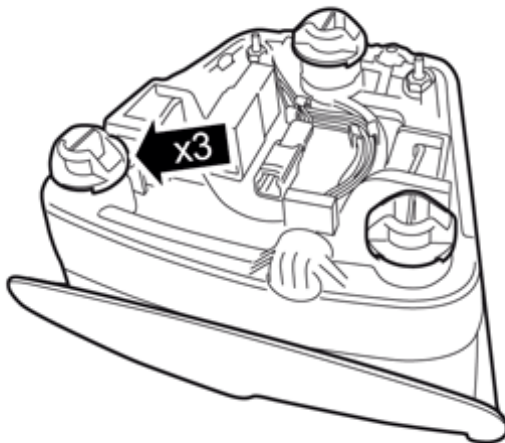

IMG-329019

Check that the three spring-loaded holders are firmly attached. If any holder has become trapped in the bottom of the steering wheel, remove it and fit it on the steering wheel module.

Installation instructions, accessories

Volvo Car Corporation Gothenburg, Sweden

22

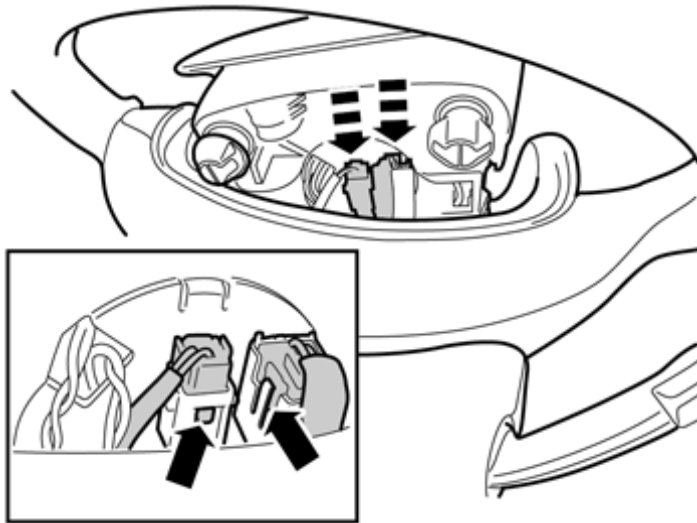

IMG-329020

Connect the two connectors to the steering wheel module.

Position the steering wheel module in the centre of the steering wheel and press it firmly into bottom of the steering wheel.

Check that it is fitted firmly and can be pressed in all around.

Reinstall the detached components in reverse order.

23

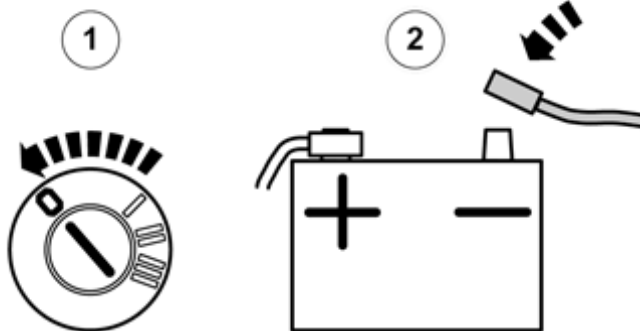

IMG-337646

Set the ignition key to position 0.

Reconnect the battery negative lead

Installation instructions, accessories

Volvo Car Corporation Gothenburg, Sweden

24

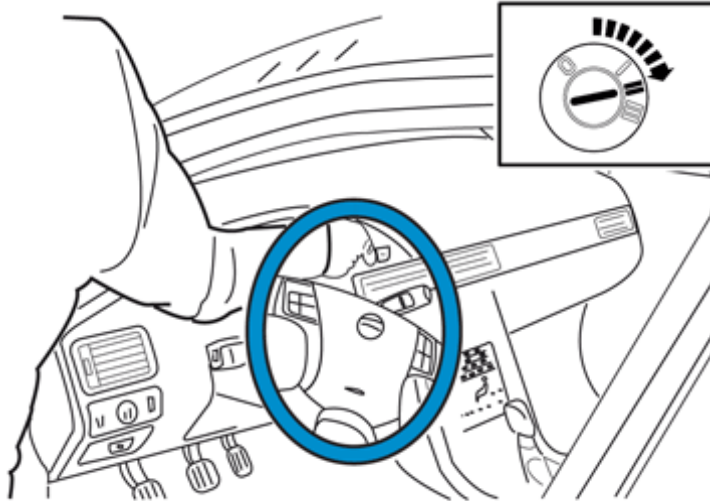

IMG-336904

Warning!

When the ignition is to be switched on for the first time after the battery has been disconnected, this must be done whilst by standing outside the vehicle, stretching your arm in and avoiding the working area for the airbags.

Set the ignition switch to position II.

25

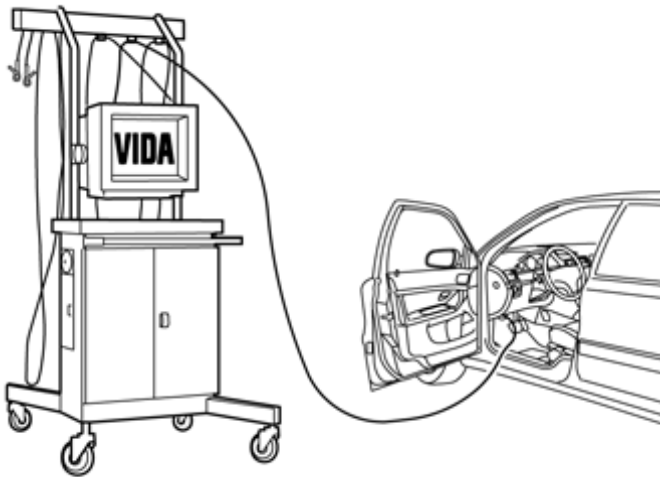

IMG-242268

Download software (application) for the accessory's function according to service information in VIDA. See VIDA or accessories catalogue for article number on software.