

Installation instructions, accessories

Volvo Car Corporation Gothenburg, Sweden

Instruction No
31370012

Version
1.1

Part. No.
31659507, 31454245, 31399361, 30756161, 31399362, 31428842, 31414192, 31339165, 31399363

Mirrors, door, cover

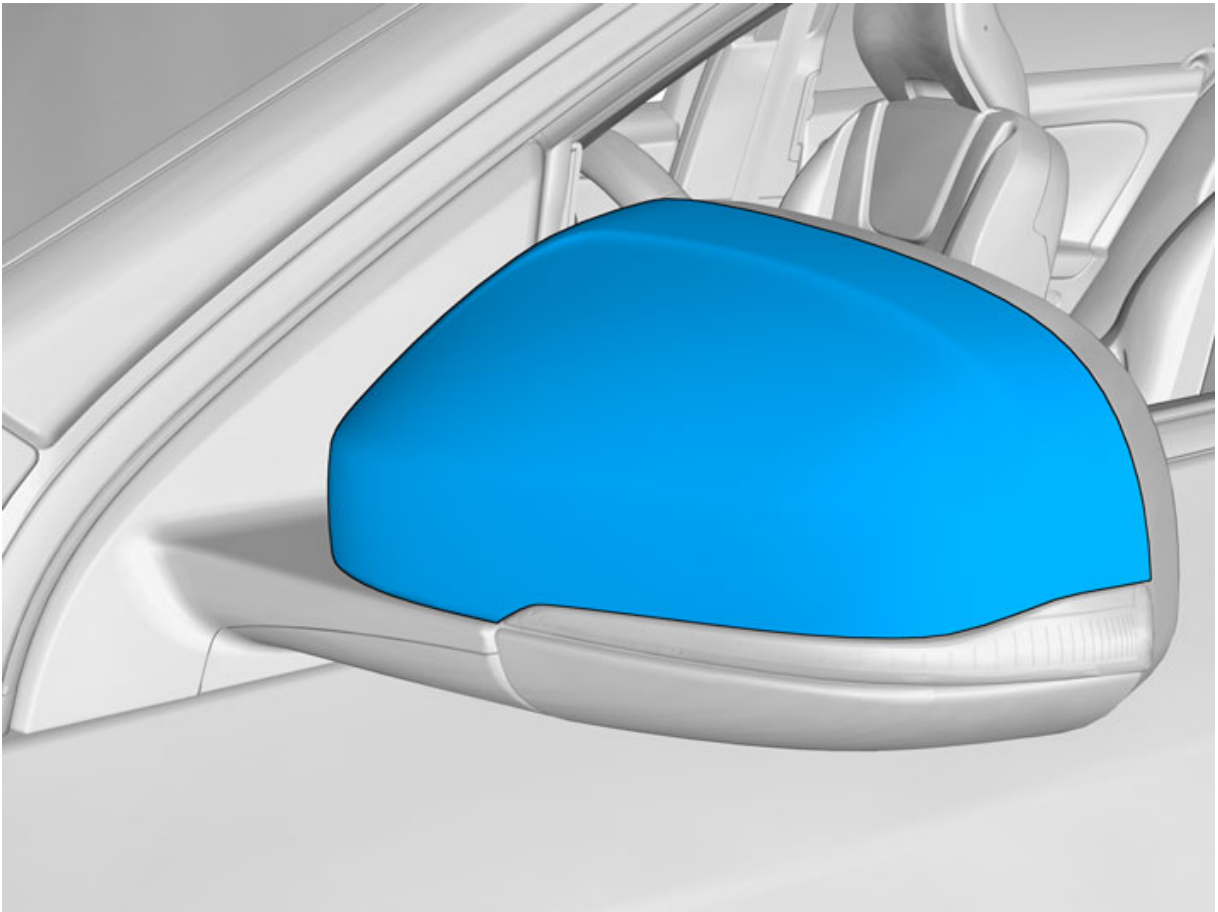

IMG-350365

Equipment

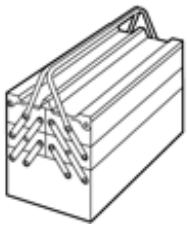

IMG-345497



IMG-338691

Installation instructions, accessories

Volvo Car Corporation Gothenburg, Sweden

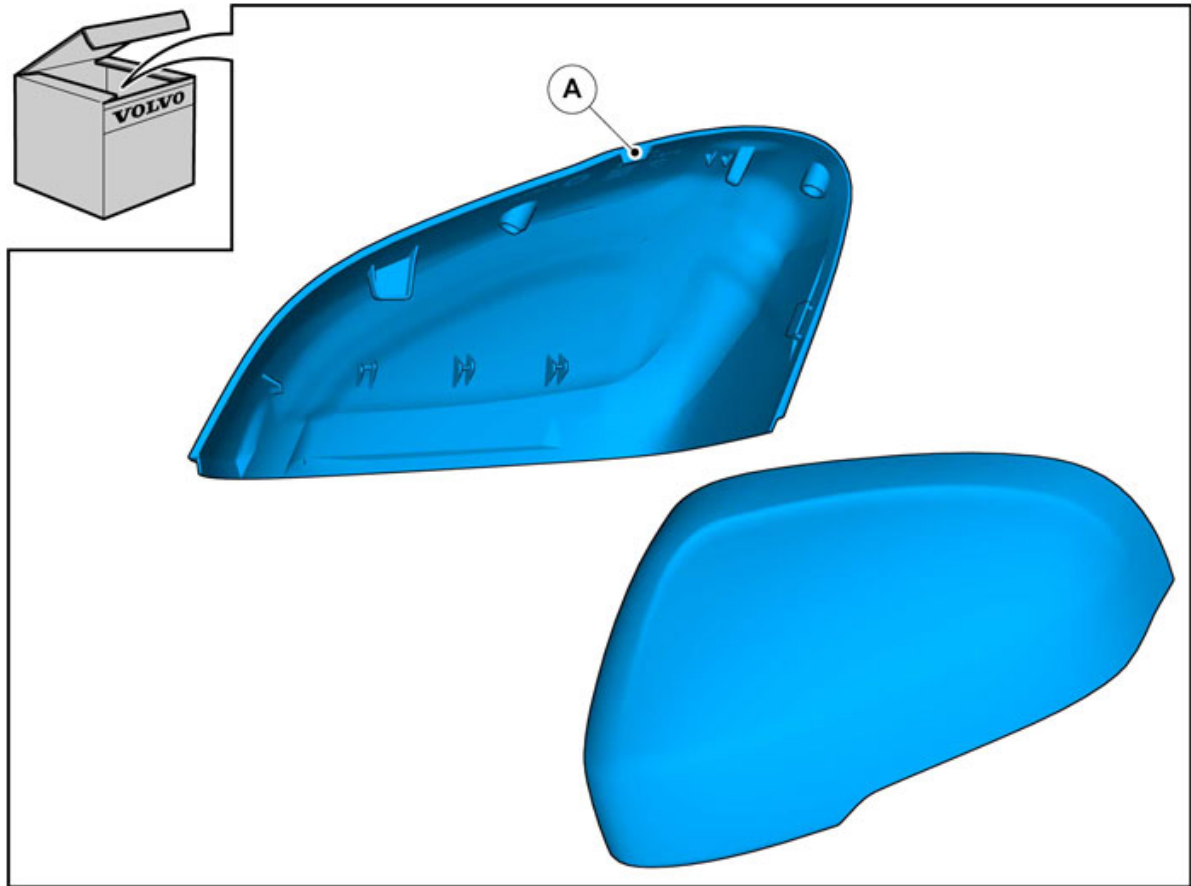

IMG-350366

Installation instructions, accessories

Volvo Car Corporation Gothenburg, Sweden

Information

- 1 Read through all of the instructions before starting installation.
Notifications and warning texts are for your safety and to minimise the risk of something breaking during installation.
Ensure that all tools stated in the instructions are available before starting installation.
Certain steps in the instructions are only presented in the form of images. Explanatory text is also given for more complicated steps.
In the event of any problems with the instructions or the accessory, contact your local Volvo dealer.

Removal

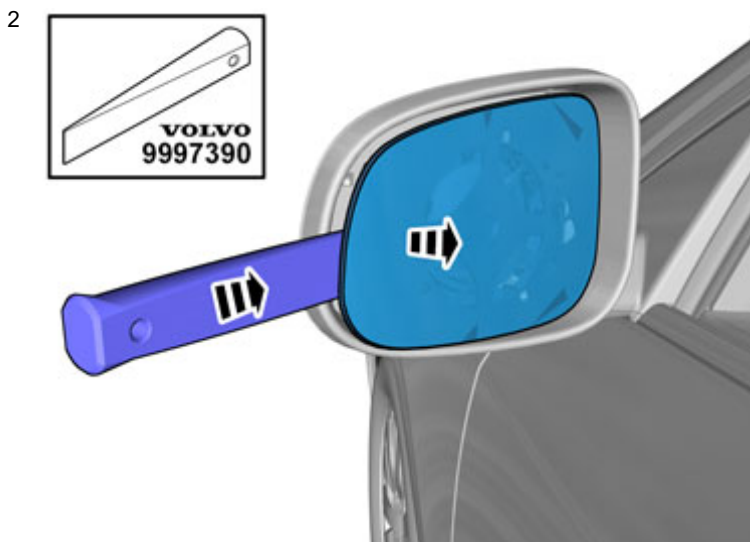

Caution!
Observe caution, the glass breaks easily.

Remove the glass from the mirror.

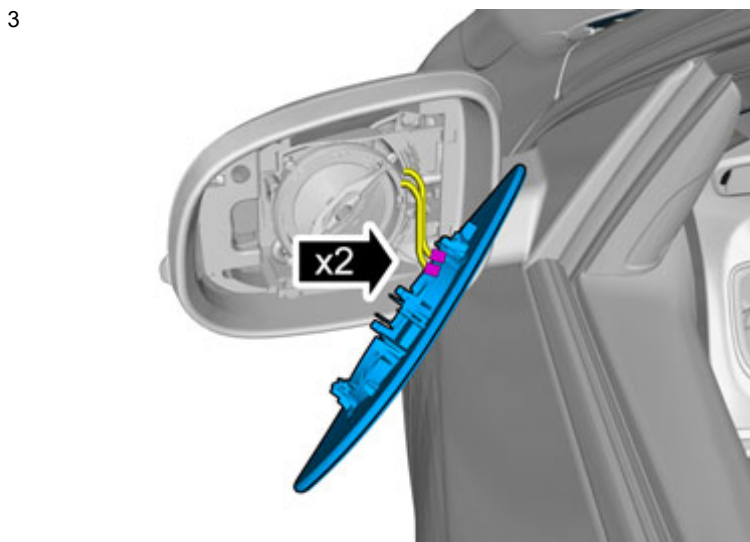

Disconnect the connectors.

Installation instructions, accessories

Volvo Car Corporation Gothenburg, Sweden

4

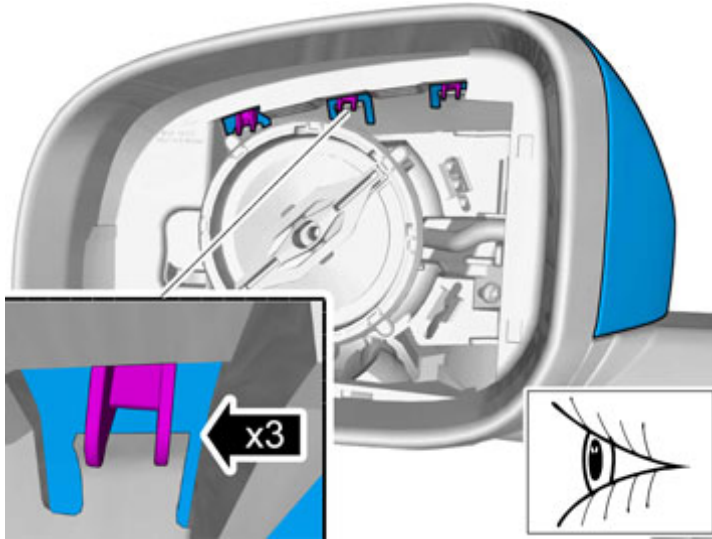

IMG-350368

5

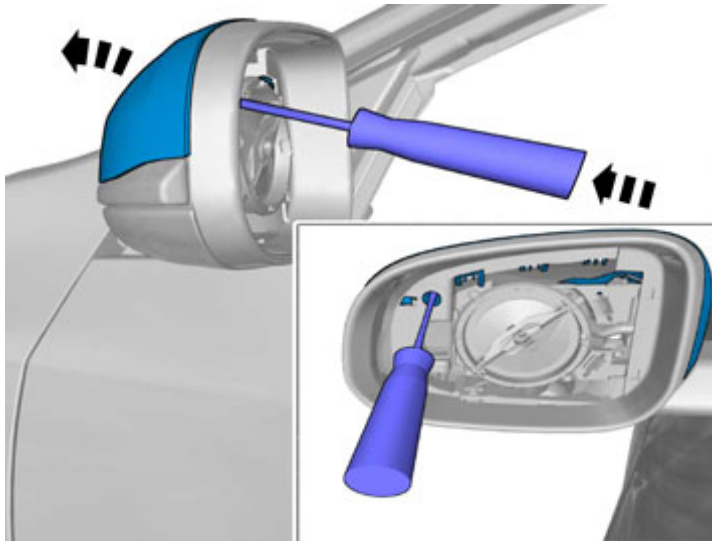

IMG-359036

Installation instructions, accessories

Volvo Car Corporation Gothenburg, Sweden

6

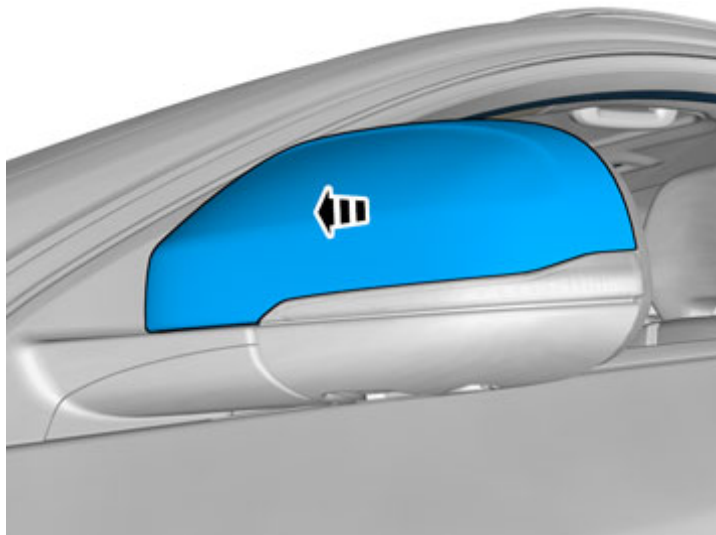

IMG-350370

7

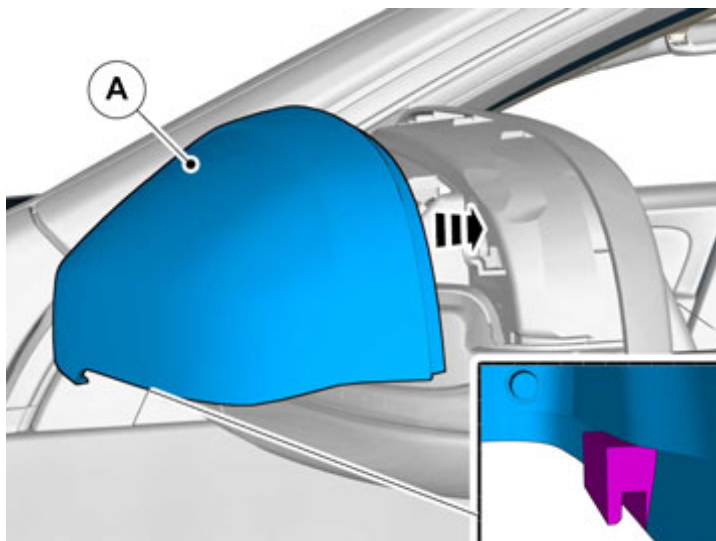

IMG-350371

Repeat all method steps for the other side.
Reinstall the removed parts in reverse order.

Installation instructions, accessories

Volvo Car Corporation Gothenburg, Sweden

8

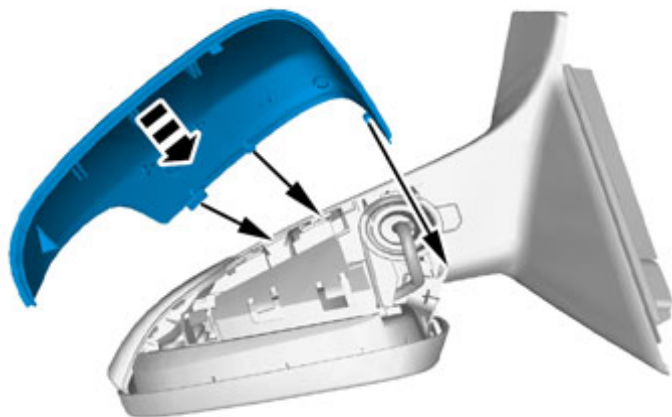

IMG-359046

9

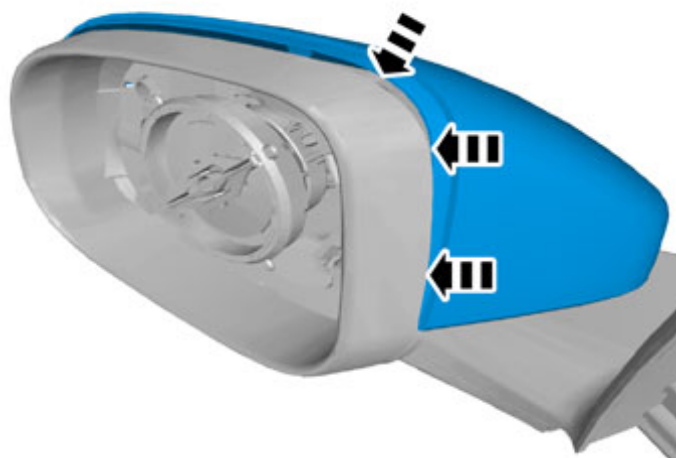

IMG-359048

Installation instructions, accessories

Volvo Car Corporation Gothenburg, Sweden

10



IMG-359047
