

Installation instructions, accessories

Volvo Car Corporation Gothenburg, Sweden

Instruction No 32261960 **Version** 1.0 **Part. No.** 32261953, 32261954

Tablet holder (tablet without charging)

Equipment

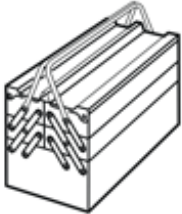

A0000162



IMG-463739

Installation instructions, accessories

Volvo Car Corporation Gothenburg, Sweden

Information

1

Read through all of the instructions before starting installation.

Notifications and warning texts are for your safety and to minimise the risk of something breaking during installation.

Ensure that all tools stated in the instructions are available before starting installation.

Certain steps in the instructions are only presented in the form of images. Explanatory text is also given for more complicated steps.

In the event of any problems with the instructions or the accessory, contact your local Volvo dealer.

Further information

2

There may be parts in the accessories kit that are not needed for this installation.

Color symbols

3

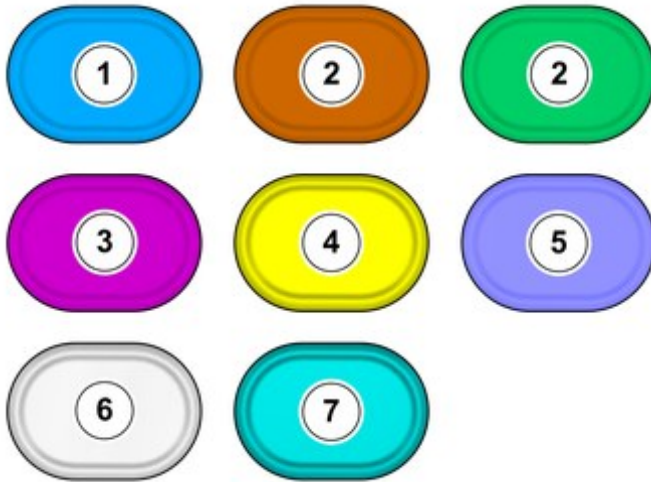

IMG-440436

Note!

This colour chart displays (in colour print and electronic version) the importance of the different colours used in the images of the method steps.

1. Used for focused component, the component with which you will do something.
2. Used as extra colors when you need to show or differentiate additional parts.
3. Used for attachments that are to be removed/installed. May be screws, clips, connectors, etc.
4. Used when the component is not fully removed from the vehicle but only hung to the side.
5. Used for standard tools and special tools.
6. Used as background color for vehicle components.
7. Used for accessory components.

Removal

4

Note!

The removal steps may contain installation details.

Installation instructions, accessories

Volvo Car Corporation Gothenburg, Sweden

5

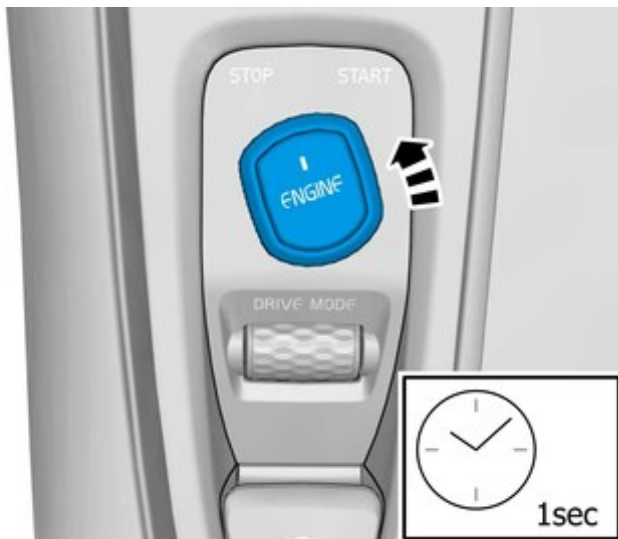

IMG-394535

Turn off the ignition.

6



IMG-394500

Move marked component forward.

Installation instructions, accessories

Volvo Car Corporation Gothenburg, Sweden

7

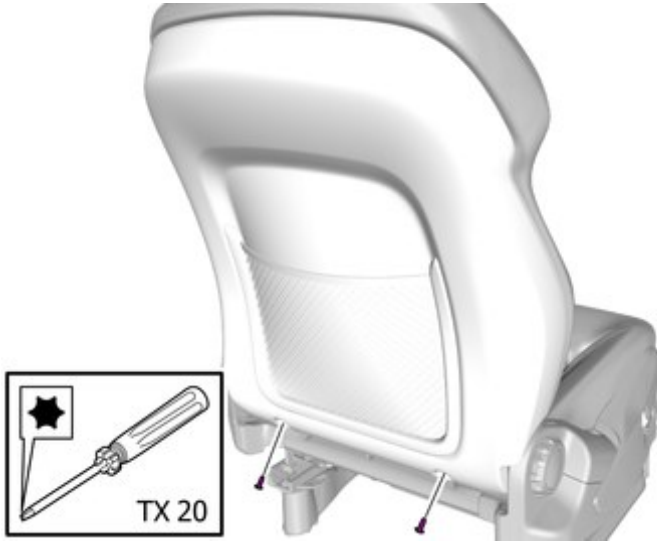

IMG-394038

Remove the screws.

8

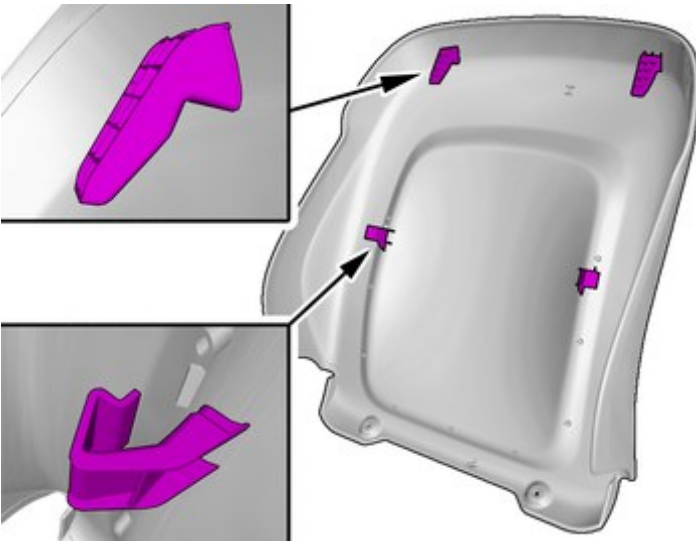

IMG-394018

Note!
The graphic shows the back of the component before removal.

Installation instructions, accessories

Volvo Car Corporation Gothenburg, Sweden

9

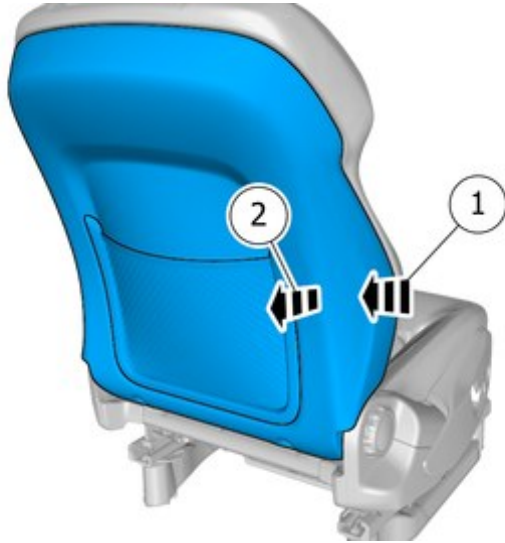

Note!

Perform the procedure one side at a time.

IMG-394039

10

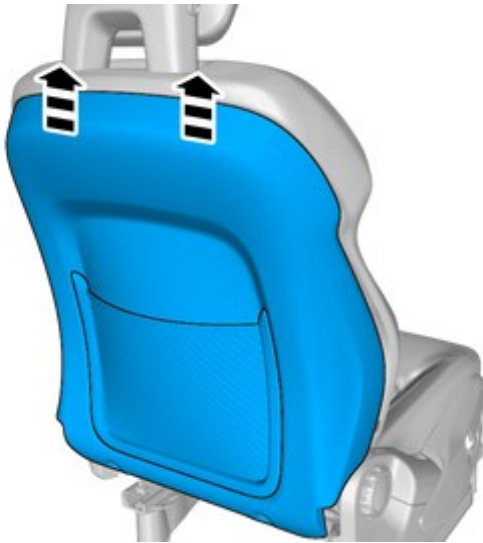

IMG-394056

Installation instructions, accessories

Volvo Car Corporation Gothenburg, Sweden

11



Note!
Orientation view

IMG-462934

12

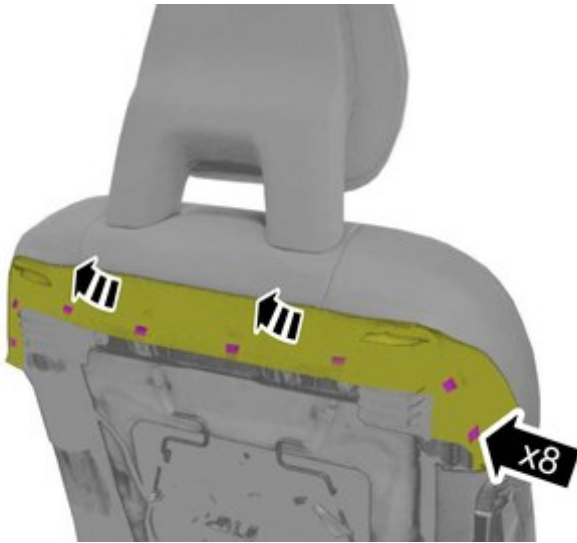

Remove the part carefully
Fold marked part aside.

IMG-462933

Installation instructions, accessories

Volvo Car Corporation Gothenburg, Sweden

13

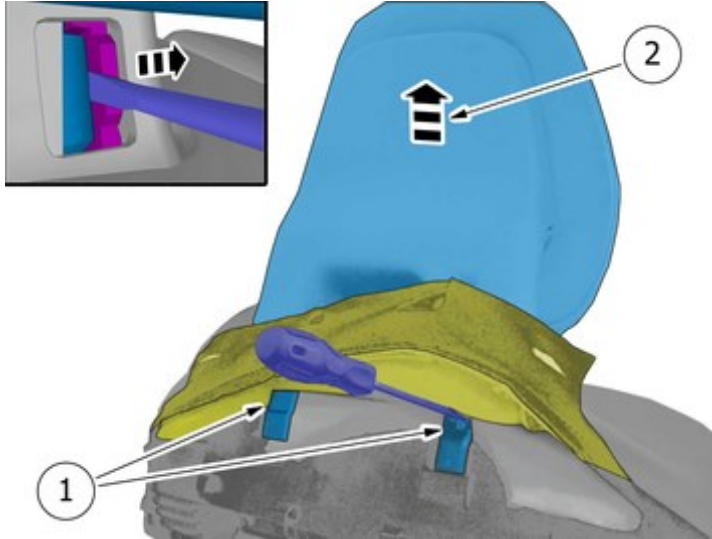

IMG-463001

Release the catches.

Remove the marked part.

14

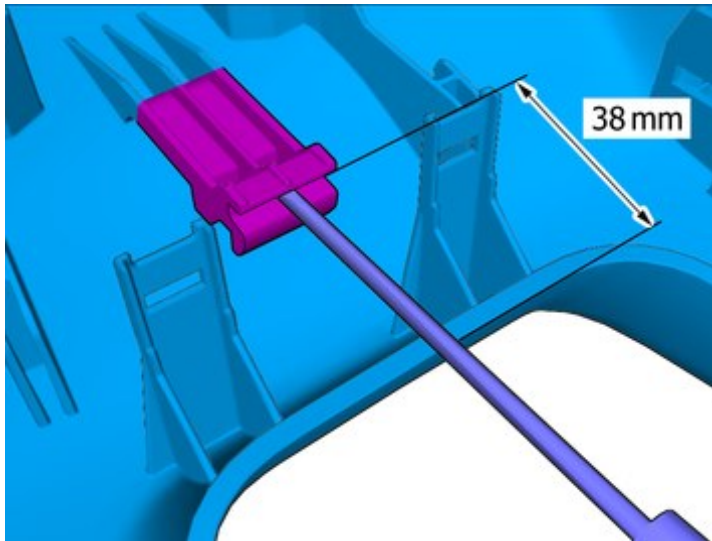

IMG-403751

Note!

The graphic shows the back of the component before removal.

Installation instructions, accessories

Volvo Car Corporation Gothenburg, Sweden

15

Remove the marked part.

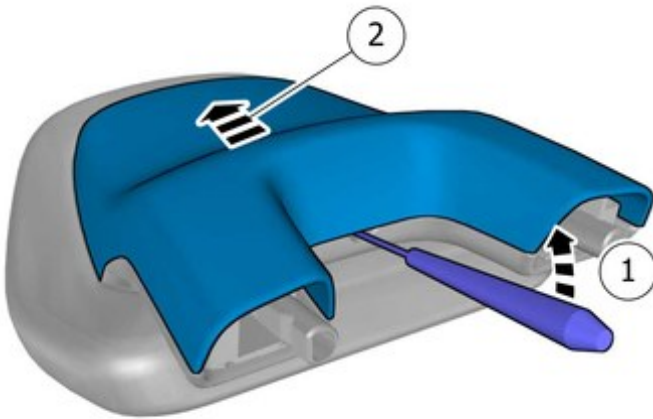

IMG-403745

16

Release the catches.

Remove the marked detail/details.

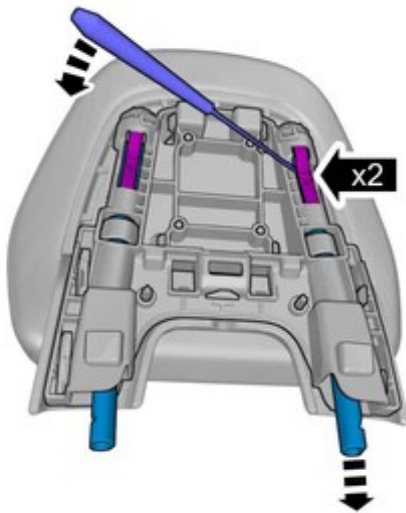

IMG-463560

Installation instructions, accessories

Volvo Car Corporation Gothenburg, Sweden

17

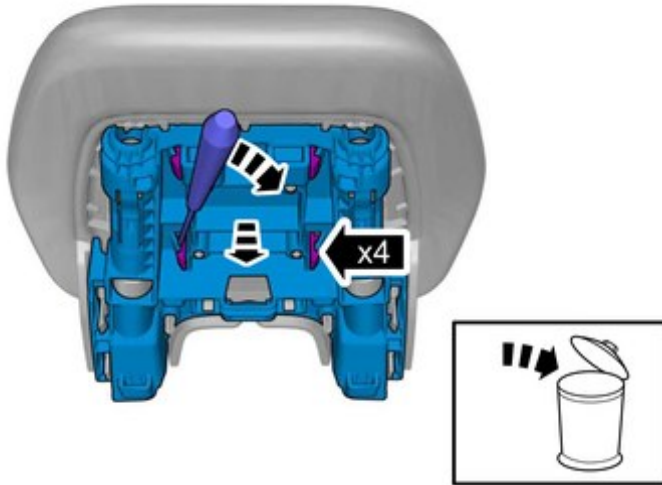

IMG-463569

Release the catches.

Remove the marked part.

Accessory installation

18

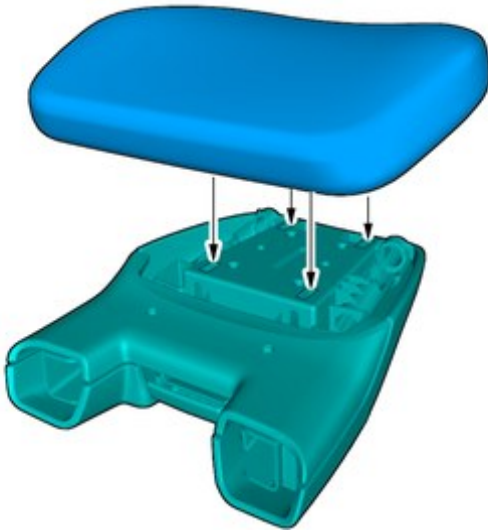

IMG-463577

Install component that comes with the accessory kit.

A click confirms that the component is in the correct position.

Installation instructions, accessories

Volvo Car Corporation Gothenburg, Sweden

19

Assemble components that come with the accessory kit.

Repeat on the other side.

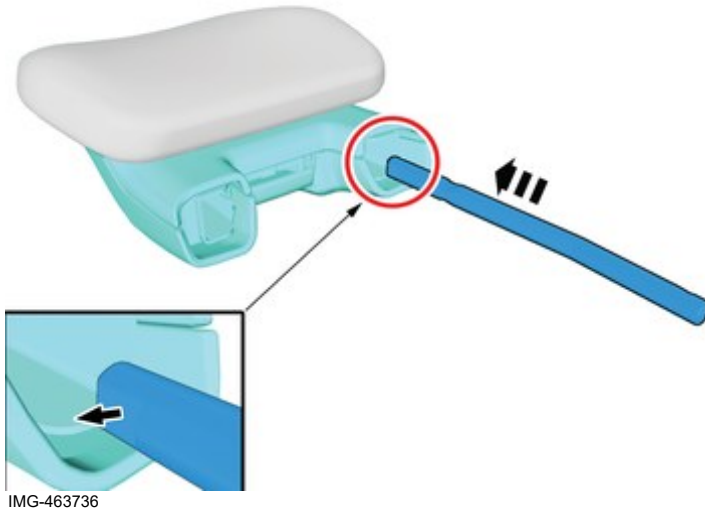

IMG-463736

20

Note!

The image shows head restraint without cushion.

Adjust the position of the component according to image.

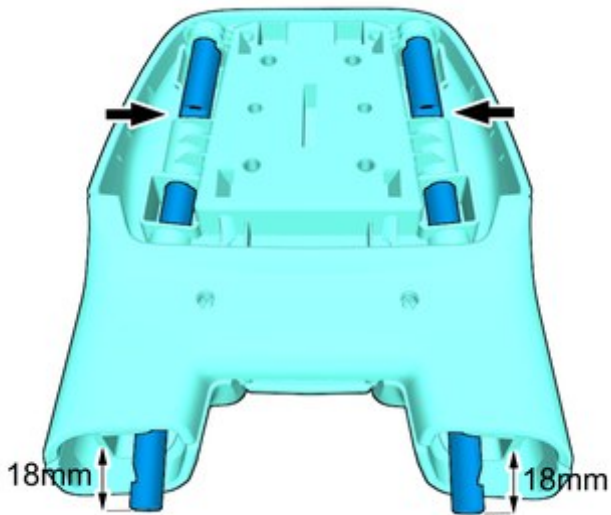

IMG-463600

Installation instructions, accessories

Volvo Car Corporation Gothenburg, Sweden

21

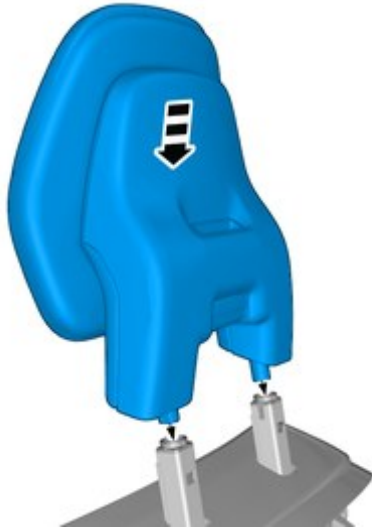

IMG-463738

Caution!

Check that the component has locked in its bottom position.

22

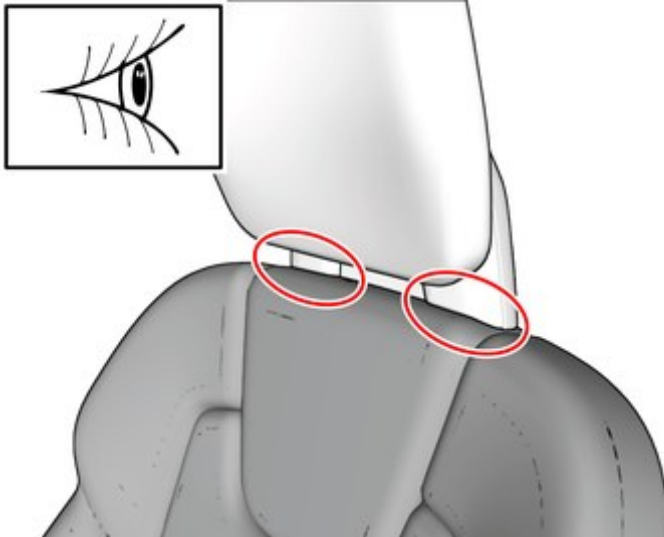

IMG-459273

Note!

Make sure that the backrest upholstery touches the head restraint, showing no space in between.

Compare with upholstery and head restraint on the other front seat.

Installation instructions, accessories

Volvo Car Corporation Gothenburg, Sweden

23

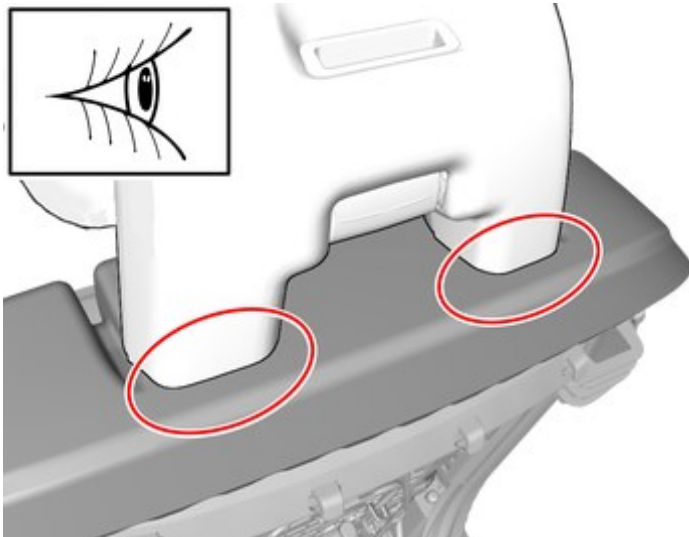

IMG-462926

Note!

Make sure that the backrest upholstery touches the head restraint, showing no space in between.

Compare with upholstery and head restraint on the other front seat.

If adjustment is necessary, follow the procedure described in the method step below.

24



IMG-407341

Caution!

Press the foam padding upward against the upholstery.

Installation

25

Reinstall the removed parts in reverse order.

26

Repeat the steps when removing on opposite side.

Repeat the steps when installing accessories on opposite side.